

Jan. 19, 1971

F. C. HOLTZ, JR

3,556,780

PROCESS FOR PRODUCING CARBIDE-CONTAINING ALLOY

Filed Jan. 3, 1966

7 Sheets-Sheet 1

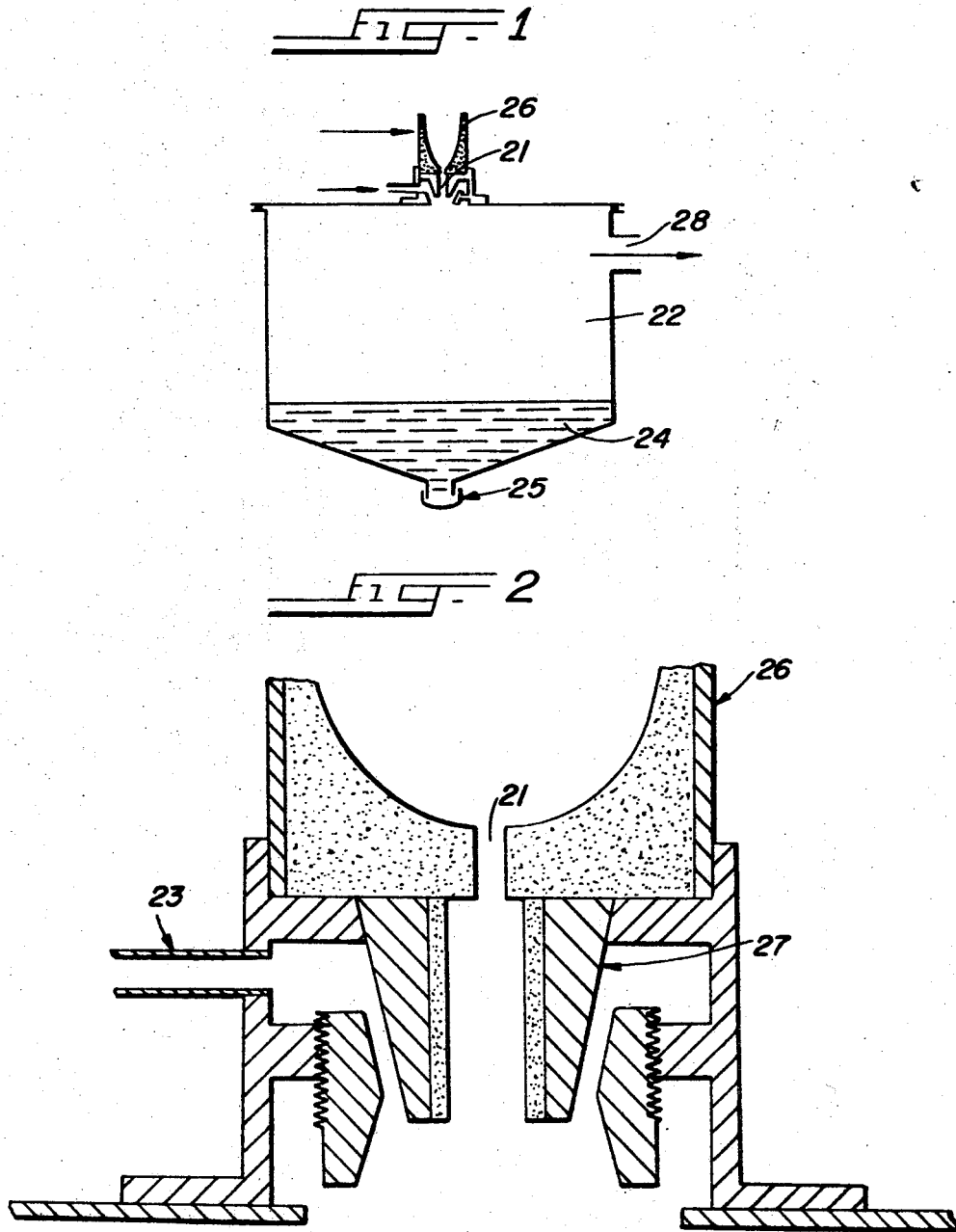

INVENTOR.

FREDERICK C. HOLTZ, JR.

BY *Albert Segel*
EH

Jan. 19, 1971

F. C. HOLTZ, JR

3,556,780

PROCESS FOR PRODUCING CARBIDE-CONTAINING ALLOY

Filed Jan. 3, 1966

7 Sheets-Sheet 2

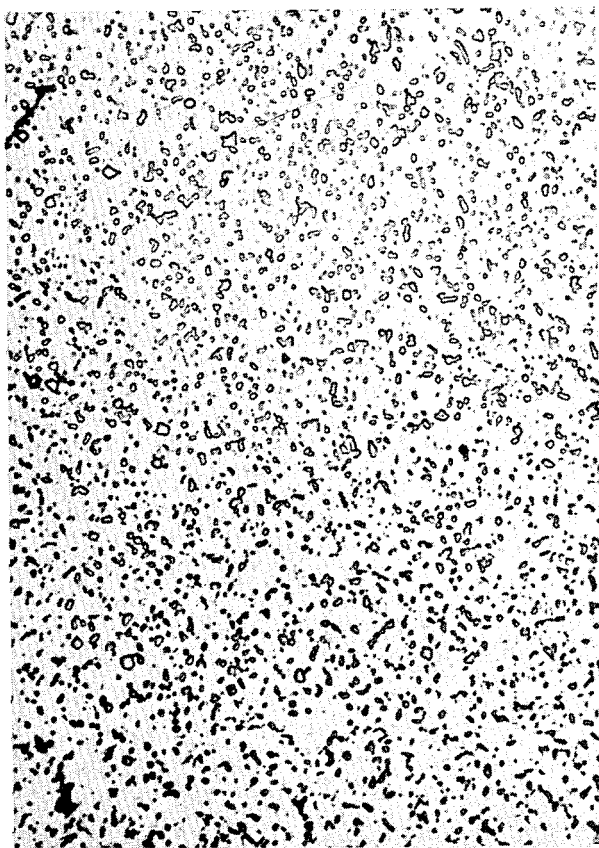

FIG. 3

INVENTOR

FREDERICK C. HOLTZ, JR.

Fidler, Bradley & Patnaude

FLZL

Jan. 19, 1971

F. C. HOLTZ, JR

3,556,780

PROCESS FOR PRODUCING CARBIDE-CONTAINING ALLOY

Filed Jan. 3, 1966

7 Sheets-Sheet 3

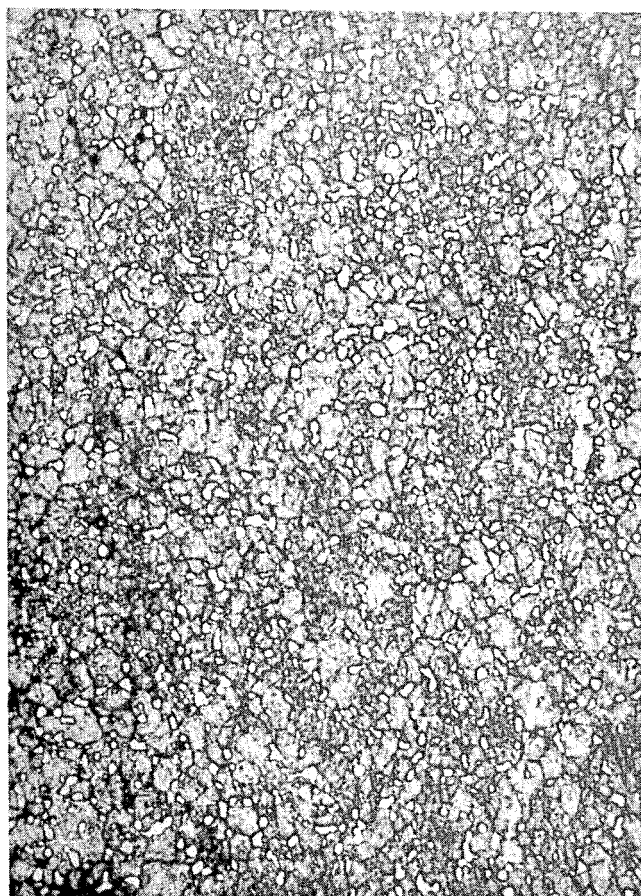

FIG. 4

INVENTOR

FREDERICK C. HOLTZ, JR

Fidler, Bradley & Patmaude

Fitz

Jan. 19, 1971

F. C. HOLTZ, JR

3,556,780

PROCESS FOR PRODUCING CARBIDE-CONTAINING ALLOY

Filed Jan. 3, 1966

7 Sheets-Sheet 4



FIG. 5

INVENTOR

FREDERICK C. HOLTZ, JR.

Fidler, Bradley & Patnaude
FCHJ

Jan. 19, 1971

F. C. HOLTZ, JR

3,556,780

PROCESS FOR PRODUCING CARBIDE-CONTAINING ALLOY

Filed Jan. 3, 1966

7 Sheets-Sheet 5

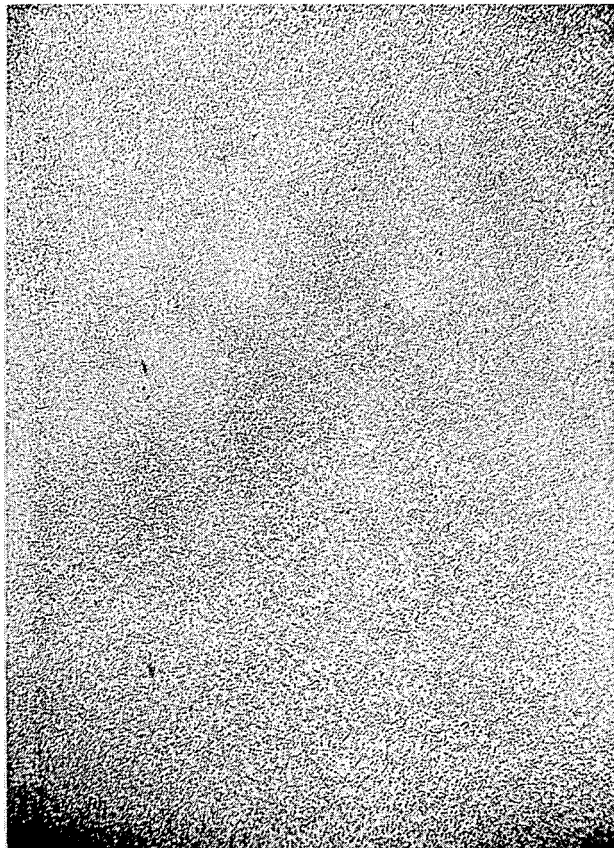

FIG. 6

INVENTOR

FREDERICK C. HOLTZ, JR.

Fidler, Bradley & Patmaude

FTL

Jan. 19, 1971

F. C. HOLTZ, JR

3,556,780

PROCESS FOR PRODUCING CARBIDE-CONTAINING ALLOY

Filed Jan. 3, 1966

7 Sheets-Sheet 6

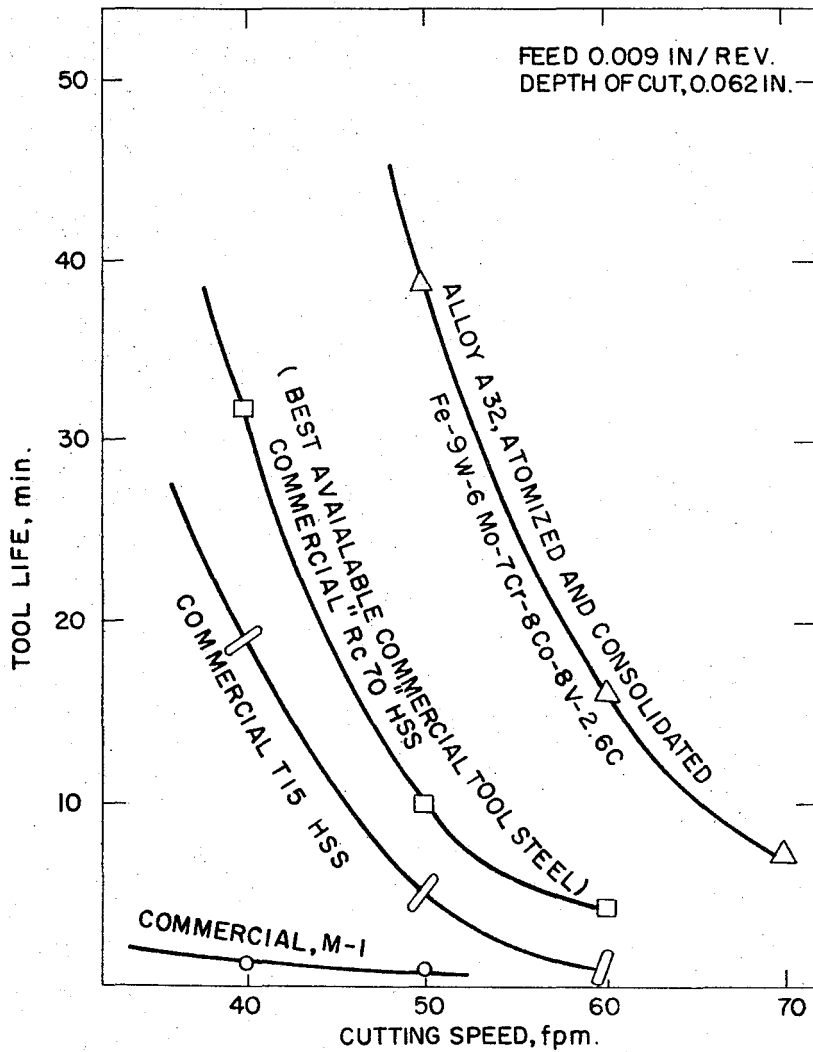
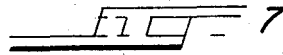

TURNINS TEST DATA FOR ATOMIZED HIGH-SPEED STEEL ALLOYS ON AISI 4340, Rc 50-52

INVENTOR.
FREDERICK C. HOLTZ, JR.

BY *Albert Siegel*
ALL

Jan. 19, 1971

F. C. HOLTZ, JR

3,556,780

PROCESS FOR PRODUCING CARBIDE-CONTAINING ALLOY

Filed Jan. 3, 1966

7 Sheets-Sheet 7

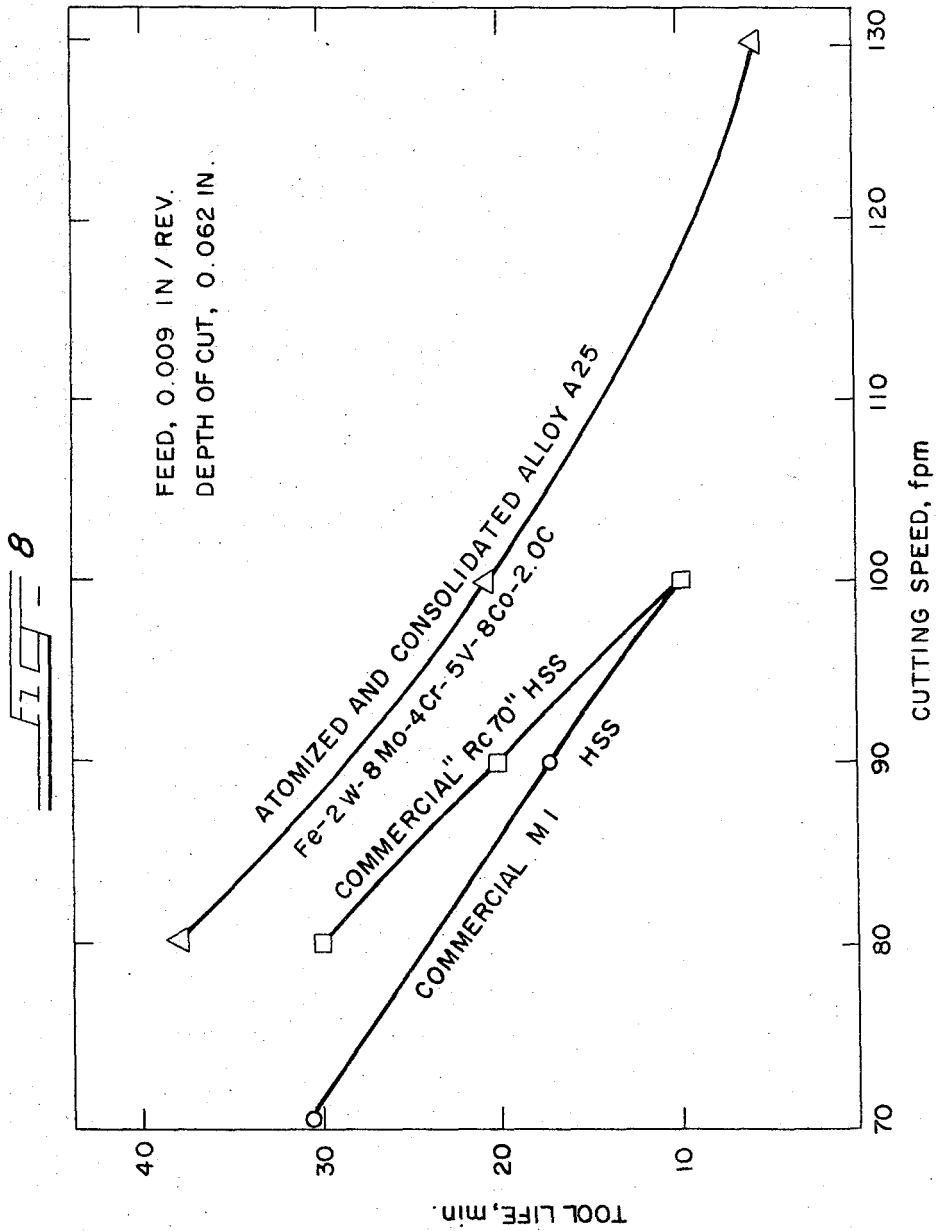

INVENTOR.
FREDERICK C. HOLTZ, JR.

BY *Albert Segel*
ATL

1

3,556,780

PROCESS FOR PRODUCING CARBIDE-CONTAINING ALLOY

Frederick C. Holtz, Jr., Evanston, Ill., assignor to IIT Research Institute, Chicago, Ill., a not-for-profit corporation of Illinois

Continuation-in-part of application Ser. No. 435,733, Feb. 26, 1965. This application Jan. 3, 1966, Ser. No. 518,058

Int. Cl. B22d 23/08; B22f 3/12

U.S. Cl. 75-203

3 Claims

ABSTRACT OF THE DISCLOSURE

Fully dense iron-base alloys characterized by having a microstructure exhibiting a substantially uniformly dispersed carbide phase of particles size predominantly less than 3 microns are produced from prealloyed powders by rapidly quenching an atomized alloy charge and subjecting the solidified particles to the step of hot consolidation in an environment protected against admission of oxygen to produce metal stock directly from prealloyed powder by plastic deformation.

The present application is a continuation-in-part of application Ser. No. 435,733, filed Feb. 26, 1965, by the present inventor.

The present invention relates to a group of iron base alloys and to their method of fabrication and more especially relates to such alloys which illustrate especially good utility as tool steels for metal cutting and die steels.

There are presently commercially available tool steels of the type designated "M-2" by the trade. Such steels are characterized by the following composition:

	Percent
Tungsten -----	5.5-6.75
Chromium -----	3.75-4.25
Molybdenum -----	4.50-5.50
Vanadium -----	1.60-2.20
Carbon -----	0.78-0.88
Balance iron, with incidental impurities.	

There are also presently available tool steels of the type designated "M-15" which are characterized by the following composition:

	Percent
Carbon -----	1.5-1.6
Manganese -----	0.2-0.4
Silicon -----	0.2-0.4
Chromium -----	4.0-5
Vanadium -----	4.5-5.25
Tungsten -----	6.0-6.75
Molybdenum -----	2.75-3.50
Cobalt -----	4.75-5.25
Balance iron, with incidental impurities.	

There are also presently available tool steels of the type designated "T-1" which are characterized by the following composition:

	Percent
Carbon -----	0.65-0.75
Manganese -----	0.20-0.40
Silicon -----	0.20-0.40
Chromium -----	3.75-4.50
Vanadium -----	0.90-1.30
Tungsten -----	17.25-18.75
Molybdenum -----	1.00-maximum
Balance iron, with incidental impurities.	

The nominal composition of such T-1 steels is normally given as iron-18%; tungsten-4%; chromium-1%; vanadium-approximately 0.8% carbon.

2

I have discovered that considerable improvement in both metallurgical and physical properties along with a concurrent considerable increase in the carbide content thereof may be made in such M-2, M-15 and T-1 steels and other steels such as M-1, M-10, M-43, M-44 and M-50 plus others, which are closely related to them in terms of strict chemical composition by practicing the atomization and metal powder consolidation processes which are hereinafter described. By this process I have found that large quantities of carbides may be readily retained as an ultra fine precipitate uniformly distributed throughout the ferrous alloy matrix. Even more specifically, the carbide phase in the alloys produced by the practice of my invention is of a particle size usually less than 2 microns and ranges from 0.5 to 3 microns. It should be understood that in some cases a very small amount of such carbides may be slightly larger than 3 microns and so long as the number of these slightly larger carbides is quite small, e.g., less than 5% of total carbide, the detrimental effect is minimal. At the same time by the present process I can also produce an ultra fine matrix grain size of less than 5 microns when this is desired.

In addition to producing such novel metallographic structures with the attendant increase in desirable physical properties, I have also found that by the present process I can considerably increase the carbide content of such steels, and have in fact fabricated alloys of similar compositions having carbon contents up to 3.4% and it is quite feasible that even higher carbide amounts can be achieved by the practice hereof.

In order to increase the carbide content of the present alloys it is necessary to increase the content of the carbide forming elements, such as vanadium, and of course carbon in the present alloy system.

It is known to those skilled in this art that in conventional M-2 steels the matrix grain size after heat treatment is usually on the order of 10 microns or higher. The carbides contained therein are coarse and irregular in shape ranging from 1 to 5 microns or larger and are not uniformly distributed through the matrix. As is seen in the attached photomicrographs there is a considerable structural difference in these conventional steels when compared with the steels resulting from the practice of my invention.

Accordingly, a primary object of my invention is to provide a new and improved group of iron base tool steels which may have a relatively high carbide content and which are characterized by a uniformly dispersed carbide phase of ultra fine particle size, i.e., from 0.5 to 3 microns and where optionally but preferably there is an ultra-fine matrix grain size, i.e., substantially all of the matrix grains are on the order of 5 microns or less.

Another object of my invention is to provide a new group of steels having special utility for tool purposes which are characterized by a relatively high concentration of carbide phase, in fact the carbide phase is of approximately twice the volume of conventional M-2 steels, which carbide phase is uniformly distributed throughout the ferrous matrix and is of ultra fine size.

Another object of my invention is to provide a wrought tool steel of relatively high carbide volume.

A further object of my invention is to provide a method of preparing tool steels which includes the steps of atomizing and consolidating powders of certain of said steels and whereby no serious oxidation occurs and substantially no deleterious oxides are formed.

Still another object of my invention is to provide a method of making such steels whereby the carbide content thereof is readily and accurately controlled.

A further primary object of my invention is to provide a new group of alloy steels characterized by a fine-grained,

uniformly dispersed carbide phase consisting of from 2.5 to 16% chromium, from 0 to 20% cobalt, from 0.8 to 12.2% vanadium, from 0 to 10% molybdenum, from 0 to 20% tungsten, from 0.6 to 4% carbon, balance substantially iron with the usual other impurities and minor additions in commercial steels and wherein the total of the molybdenum content plus one-half of the tungsten content is a value greater than 4 but less than 15 with the further requirement that there be adequate carbon present to permit the alloy to be hardened to a Rockwell C level of at least 60.

A more specific object of my invention is to provide novel ferrous base alloys having a chemical composition of from 0 to 20% tungsten; from 2.5 to 16% chromium; from 0 to 10% molybdenum; from 2 to 12.2% vanadium; and from 0.6 to 4% carbon, along with incidental impurities which composition is characterized by a substantially uniformly dispersed carbide phase in the major phase (ferrous) matrix and having a carbide phase, substantially all of which has a grain size of less than 3 microns.

Still another object of my invention is to provide a novel group of tool steels characterized by a unique microstructure which are fabricated by the consolidation of prealloyed powders.

These and other objects, features and advantages of my invention will become apparent to those skilled in this particular art from the following detailed disclosure thereof and the accompanying drawings in which:

FIG. 1 schematically illustrates an atomizing chamber for use in the practice of the present invention;

FIG. 2 schematically illustrates atomizing apparatus for use herewith;

FIG. 3 is a photomicrograph at a magnification of 2000, unetched, of a consolidated alloy made as herein taught;

FIG. 4 is a photomicrograph at 2000 magnification showing the structure of an atomized and consolidated alloy made as herein taught;

FIG. 5 is a photomicrograph at 2000 magnification showing the structural commercial M-2 steel as hardened and tempered.

FIG. 6 is a photomicrograph at a magnification of 500 of a consolidated alloy made as herein taught;

FIG. 7 is a graph showing turning test data for one of the alloys made as herein taught in comparison with other steels; and

FIG. 8 is a graph of turning test data for another of the alloys made as herein taught in comparison with other steels.

In preparation of the present alloys I preferably commence with an atomization process, although, of course, other methods of producing prealloyed powders which in turn, upon consolidation as herein taught, yield the present novel microstructures may be used. The apparatus for atomization is schematically illustrated in FIGS. 1 and 2 although it will be understood that other similar apparatus may be likewise employed. An appropriate alloy charge of the desired composition was first weighed up, melted in a suitable crucible and then the molten alloy was poured through the orifice 21 at the top of the atomizing chamber 22. In such chamber the molten stream is first broken up into fine particles and then quickly quenched by a high pressure inert gas stream entering the chamber 22 through the gas inlet port 23. In order to assure rapid quenching of the molten, atomized metal powders I provide at the bottom of the apparatus a water reservoir 24 which may operate in conjunction with the atomizing stream to quench the particles.

The atomizing chamber which is fabricated of a steel shell, water-cooled, is approximately three feet in diameter and approximately two feet in height. Obviously, other dimensions may be employed without departing from the spirit or scope of my invention. At the bottom of the chamber is slightly conical and at the center thereof

I provide a capped opening 25 for metal powder and water removal.

Approximately five pounds of the present alloy composition were heated to approximately 200° to 300° F. above fusion temperature under an argon atmosphere to protect the melt. Argon atomizing gas at 350 p.s.i. was fed into the chamber 22 through the inlet port 23 first to purge and then to atomize the molten metal. After purging the melt was poured into the tundish 26 from whence it flowed into the chamber 22 through the opening 21.

Beyond the opening 21 I provide a refractory lined cone 27 at the exit end of which the atomizing gas strikes the molten metal stream to break up such stream into fine particles. In addition, this impact quenches the molten particles so that they are solidified even before they are finally cooled in the water reservoir. Quenching is therefore quite rapid.

I also provide an exhaust port 28 for argon exit.

Some of the alloy compositions which were so atomized (and subsequently treated as hereinafter described) are listed in Table I.

TABLE I.—ALLOY COMPOSITIONS

Alloy Number:	Weight percent						
	W	Cr	Mo	V	C	Co	Other
1	6	4	5	2	0.8		
2	6	4	5	5.6	1.1		
3	6	4	5	9.1	1.5		
4	6	4	5	12.2	1.8		
5	5.5	3.6	4.7	5.25	1.25		
6	5	3.2	4.2	4.7	1.7		
9	6	4	5	5	1.4		
10	6	4	5	5	1.7		
11	6	4	5	5	1.7		
12	18	4			6	1.8	
13	18	4			6	2.0	
14	18	4			6	2.2	
22	6.5	4.5	4	10	2.35	5	
23	6.5	4.5	4	10	2.75	5	
24	6.5	4.5	4	10	3.15	5	
25	2	4	8	5	2	8	
27	6.5	4.5	4	10	3.4	5	
28	6.5	4.5	4	6	3.4	5	4% Ti.
29	5	4	6	8	3	12	
30	4	15	5	8	2.85	8	
31	8	6.5	9	3.5	1.8	18	
32	9	7	6	8	2.5	8	
33	8	12	5	7	2.5	15	

NOTE.—Balance substantially iron with the usual incidental impurities.

After atomization the alloy powders were withdrawn from the atomizing chamber and dried. Approximately 75 to 85% of the atomized powders were finer than 80 mesh and from 15 to 30% were finer than 325 mesh.

In some cases it may be desirable to treat the atomized powders in a hydrogen atmosphere at 1500° to 1600° F. for a few minutes prior to consolidation to reduce any oxide film contained thereon but this is an optional step in my process.

The atomized alloy powders were next consolidated into solid stock. To accomplish this, although certainly many other means of consolidation may be employed, the powders were first canned in Inconel cylinders that were lined with molybdenum foil to permit easy stripping of the canning material from the hot worked ingot. After the bottom of the cylinder was welded on, the alloy powders were poured into the Inconel cans and pressed at pressures ranging from 5 to 30 tons per square inch. I found that the higher pressures did not produce a significant increase in powder density for most alloys, apparently because of the spheroidal shape and extreme hardness of the powder particles. Accordingly a major portion of the compositions were pressed at from 5 to 15 t.s.i. Following such step the top lid of the cylinder was inserted and welded into place. I note parenthetically that a brief study indicated that evacuation of the canned, high-speed tool steel powders did not produce a significant improvement

in the wrought product so subsequently all cans were sealed without evacuation.

The welded cans were heated to forging temperatures in air and soaked approximately for 10 minutes prior to upset hammer forging on a 250-pound capacity mechanical forge unit. Forging was used to produce pancake ingots approximately 1/2 inch thick. After forging, the canned billets were hot rolled to approximately 0.22 to 0.24 inch using a 10% reduction per pass, this representing a total reduction in thickness of 90 to 92% of the original billet thickness. The canning material was then removed and the rolled plate sectioned for metallurgical examination and mechanical property evaluations. It should be noted that the consolidation of the powders into wrought stock was accomplished without resorting to conventional sintering techniques and without adding carbon in any manner to the powders.

Of the alloy compositions listed in Table I it is noted that Alloy Number 1 is commercial M-2 stock. The other alloys which are presented represented novel compositions in that they are greatly enriched in carbon and carbide forming elements, especially vanadium.

After the alloy powders resulting from the atomization technique were canned they were heated to temperatures ranging from 1850° to 2150° F. and hammer forged and then hot rolled to consolidate. It should be noted that press forging or extrusion into solid shapes or other means of consolidating said powders may be employed.

The present alloys are preferentially treated by the steps involving hot working, annealing, machining to shape, austenitizing and tempering.

The method of producing wrought stock directly from atomized powders by for example canning and hot working as taught herein, eliminates the necessity for annealing, cold pressing, sintering and adjusting the carbon content of the powders as has been disclosed in U.S. Pat. No. 3,150,444 of O. W. Reen. Elimination of these time-consuming additional steps is an obvious economic advantage, but of even greater importance is the fact that the chemical analysis of my final wrought products can be accurately controlled, especially with regard to the carbon content. As taught herein, the amount of carbon desired in a particular alloy is selected prior to atomization and substantially this exact amount will be uniformly distributed in the final wrought stock. The improvement of accurate control and uniform distribution of carbon and other constituents becomes apparent when the practice of this invention is compared to that of the

prior art. As described in the teaching of the prior art, the carbon content of an atomized high-speed steel, for example, decreases substantially when annealed and sintered in so-called pure dry hydrogen, thus requiring large additions to the powders of carbon in the form of lampblack, graphite, or a carbonaceous gas. A portion of this carbon loss occurs during the lengthy annealing treatment which is necessary to soften the atomized powders so that they may be cold pressed. It is known to those skilled in the art that "pure dry hydrogen" such as that used in commercial practice actually contains a sufficient quantity of oxygen and/or water vapor to oxidize carbon and other elements present in tool steels especially in powder form. It is further known that in addition to the loss of carbon in the form of a gas such as CO or CO₂, oxidation of the chromium constituent, for example, will also take place in the commercial "dry hydrogen" atmosphere. Thus the lengthy annealing of atomized powders as taught in the prior art results in a serious carbon loss and in the formation of additional oxides on the surface of the powders.

By contrast, the method taught herein utilizes direct working in sealed cans, for example, of the atomized powders which prevents further oxidation when the powders are heated for consolidation by forging or other powder working methods. There is essentially no carbon loss, nor are additional deleterious oxide films formed on the powders during consolidation. This accurate control of the carbon content was obtained without the necessity for adding carbon to the powders. On the other hand, when the atomized powders are annealed and sintered as taught in the prior art, the amount of carbon in the final product is extremely difficult to control.

As noted above, in the practice of the powder consolidation step of this invention no, or substantially no, deleterious oxides are formed. "Deleterious oxides" are those which, by their morphology (such as continuous or semicontinuous films on the prealloyed powder particles), render the powders difficult to consolidate, cause structural weakness of the consolidated product, or require an excessive amount of mechanical working of the product to break up and disperse such films so that they do not adversely affect the strength properties.

It also should be noted that the present alloy compositions are consolidated in the hot state to substantially fully dense stock by plastic deformation of the prealloyed powders.

Table II presents Rockwell C harness data of some of the present alloys treated as shown in the table.

TABLE II.—ROCKWELL C HARDNESS DATA

Alloy Number:	Austenitizing temperature	Hardness as quenched	Hardness after 2 hours plus 2 hours tempering		
			1,000° F.	1,050° F.	1,080° F.
10	2,175	67.8	62.0	62.8	61.9
	2,200	68.6	63.8	64.1	63.2
	2,225	68.6	64.6	66.7	63.9
	2,250	66.0	64.0	65.0	64.0
11	2,125	63.7	61.1	63.3	60.0
	2,150	63.9	63.1	64.9	63.0
	2,175	63.8	63.5	63.2	63.1
	2,200	61.5	62.0	61.5	58.0
15	2,200	64.4	62.2	60.5	-----
	2,250	65.5	63.9	62.5	-----
16	2,150	66.0	64.1	65.3	-----
	2,175	64.6	-----	67.0	-----
	2,200	63.7	66.9	66.1	-----
17	2,150	64.3	66.9	67.0	-----
	2,175	62.1	-----	67.0	-----
	2,200	60.8	66.5	66.8	-----

TABLE II—Continued

Alloy Number:	Austenitizing temperature	Hardness as quenched	Hardness after 2 hours plus 2 hours tempering			
			950° F.	975° F.	1,000° F.	1,050° F.
22.....	2,175	63.1	-----	-----	62.8	61.8
	2,225	63.2	-----	-----	-----	61.0
23.....	2,175	68.1	-----	-----	66.1	65.0
	2,225	68.8	-----	-----	67.1	64.1
24.....	2,175	69.0	68.1	-----	67.2	-----
	2,225	69.1	68.7	-----	69.0	-----
25.....	2,175	67.8	68.1	-----	67.5	-----
	2,225	67.7	68.5	-----	68.7	-----
27.....	2,175	71	71	-----	70	-----
	2,225	71	70	-----	71	-----
28.....	2,175	71	71	-----	70	-----
	2,225	70.5	71	-----	71	-----
29.....	2,100	70.6	70 (925°)	-----	69.5 (1,025°)	-----
	2,150	70.5	70 (925°)	70.5	-----	70 (1,025°)
30.....	2,100	64.4	65 (925°)	64.5	-----	63.4 (1,025°)
	2,150	64.5	65 (925°)	65	-----	69.5 (1,025°)
31.....	1,950	68.2	70	-----	-----	-----
	2,050	68.2	70	-----	-----	-----
	2,150	67.5	70.5	-----	70	-----
	2,200	66.4	70.5	-----	70	-----
32.....	2,150	65.1	68	-----	69	-----
	2,200	67	69.3	-----	70.5	-----
	2,250	67	69	-----	-----	-----
33.....	1,950	64.6	66.4	-----	-----	-----
	2,050	65.1	66.8	-----	-----	-----
	2,150	65.1	67.8	-----	67.0	-----
	2,200	65.0	67.1	-----	67.0	-----

Table III presents some room temperature transverse rupture data of the present alloys.

To clearly see the advantageous metallographic structure of the present alloy system reference should next be

TABLE III.—ROOM TEMPERATURE TRANSVERSE—RUPTURE DATA

Alloy Number:	Quenching temperature, °F.	Tempering temperature, °F.	Time, hour	Hardness, Rc	Modulus of rupture, p.s.i.
16.....	2,175	1,050	4	66.0	374,000
16.....	2,175	1,050	4+4	64.1	497,000
17.....	2,175	1,050	4	64.8	362,000
17.....	2,175	1,050	4+2	67.1	348,000
25.....	2,225	1,000	2+2	70	318,000
29.....	2,150	975	2+2	70.5	316,000
30.....	2,150	975	2+2	65	494,000
31.....	2,150	950	2+2	71.5	281,000

Of the foregoing alloys, Alloy Number 16 which contains 5% vanadium and 1.8% carbon was used for subsequent cutting tests. A cutting tool was fabricated and then used on AISI 4340 steel which was quenched and tempered to 352 BHN. The alloy had a somewhat longer tool life than commercial M-2 steel at 70 surface feet per minute (49 minutes versus 30 minutes) and also at 100 s.f.m. (14.5 minutes versus 10 minutes). The atomized consolidated alloy also had a longer tool life than commercial T-15 steel at 100 s.f.m. (14.5 minutes versus 11.5 minutes).

The critical advantages stemming from my invention are readily seen in comparing FIGS. 3 and 4 with FIG. 5. In FIG. 3 there is illustrated the fine carbide phase and the uniform distribution thereof as is found in the present alloy systems. This particular photomicrograph is unetched. FIG. 4 is a photomicrograph of the atomized consolidated alloys made as taught by my process and it is apparent that the carbide phase is uniformly distributed and is very fine size ranging up to 3 microns. The matrix at the same time is quite fine, ranging up to 5 microns. In distinction to this the commercial M-2 alloys as shown in FIG. 5 have a matrix grain size of greater than 10 microns, the carbide phase is not uniformly dispersed therein and the carbide phase is of relatively large grain size.

In the preferred alloy structures of my invention the matrix grain size is less than 5 microns although it is possible but somewhat less desirable by the practice of my invention to have the matrix grain size somewhat larger than is found in the preferred embodiment hereof.

had to the photomicrograph at 500x comprising FIG. 6 hereof. This is a photograph of the alloy designated 32 in the foregoing tables. The fine carbide phase and its uniform distribution throughout the matrix is immediately apparent. This is a consolidated and annealed specimen.

Alloy Number 32 was fabricated into one-quarter inch diameter stub length twist drills. To provide appropriate comparison a drill of similar geometry was fabricated from commercial "RC-70" steel, the best presently available high speed steel. Both such twist drill materials were then employed to drill holes in AISI 4340 stock quenched and tempered to a Rockwell C hardness of 37. Alloy 32 produced 29 holes whereas the commercial RC-70 drill produced only 17 holes before excessive corner wear and chipping prevented further drilling. The toughness of Alloy 32 was demonstrated by the absence of chipping or breakage.

Additional advantages of the present alloys may be readily appreciated upon reference being made to the two charts of FIGS. 7 and 8.

FIG. 7 shows some turning test data for Alloy 32 and compares the results with three commercially available tool steels. The tests which are charted on that graph were run on AISI 4340 steel having a Rockwell C hardness of 50 to 52. I note that "RC-70" as indicated above, is considered the best commercially available tool steel. Yet Alloy 32 is far superior to it. For example, as a cutting speed of 60 feet per minute Alloy 32 had a tool life of 17 minutes compared to RC-70's 4 minutes. At 50 f.p.m. the difference is 39 minutes compared to only 10

minutes. The important implications and advantages of this will be immediately apparent to those skilled in this art.

FIG. 8 compares Alloy 25 with two other commercial steels noted on the graph. This is lathe turning test data on AISI 4340 steel of Rockwell C hardness 38 to 40. At 100 feet per minute, for example, Alloy 25 had a tool life more than double both RC-70 and commercial M-1 steels (22 minutes versus 10 for the others).

As noted above the carbide volume of most of the present alloys was increased by adding carbon together with the most desirable carbide forming element vanadium to form vanadium carbide. It is known that the additional alloying amounts of these two elements when added to high speed steels should be such that the ratio of carbon to vanadium is approximately 1 to 4.

The carbide volumes of some of the present alloys were increased by forming other carbides in addition to vanadium carbide.

It should be appreciated by those skilled in the art that a portion of the carbide forming elements partitions between the ferrous matrix and the carbide phase making it extremely difficult if not impossible to predict the exact ration of carbon to carbide forming elements to be added.

However, as set out in the present specification and claims the carbon content of these alloys ranges from 0.6 to 4.0% by weight. Some of the carbon in the charge combines with the carbide-forming additives such as vanadium to produce hard carbide particles. Additional carbon is required to permit the iron-rich matrix to be hardened to the extent that the alloy can be hardened to at least Rockwell C 60 by using standard hardening techniques. Amounts of carbon greatly in excess of that required to harden the matrix and to form hard carbides with alloying constituents may lead to the formation of other carbide phases as well as excessive retained austenite after heat treating, either of which may be undesirable.

The tungsten and molybdenum concentrations in the present alloys are so related whereby the total of the molybdenum plus one-half of the tungsten content should be greater than 4 but less than 15 with the molybdenum ranging from 0 to 10% and the tungsten from 0 to 20%. Accordingly, when the tungsten content is high, there can be no, or small amounts of molybdenum. At the same time, a high molybdenum content can permit the elimination of tungsten.

The amount of chromium that can be used herein ranges from 2.5 to 16%. If greater oxidation resistance is desired the chromium content will approach the higher end of the range.

Cobalt is an optional alloying additive. This element acts as a solid solution strengthening agent and by adding it to the present alloy system one increases the elevated temperature strength.

Vanadium is the most important carbide forming element used in this alloy system. All or a portion of the vanadium may be replaced by other strong carbide elements selected from the group, titanium columbium, tantalum, zirconium and hafnium taken singly or in combination in amounts up to 5% by weight. The use of these materials is optional. When these elements are used the vanadium content can range from 0 to 12.2% and the Ti, Cb, Ta, Zr and Hf can range from 0 to 5% with the proviso that the total vanadium plus one, a group, or all of these others total at least 0.8% and not be greater than 12.2%.

Achieving a fine, uniformly dispersed carbide phase permits the incorporation of a substantially larger volume of this hard, wear-resistant component than is found in prior art materials without a concurrent reduction in strength or toughness. Conventionally processed tool steels and other ferrous alloys are melted and then poured into ingot molds which are of such size, shape and characterized by such a thermal conductivity that the metal requires at least several minutes before solidification is complete. Dur-

ing this time interval the carbide phase nucleates and then grows to appreciable size. Subsequent hot working of the ingots causes some break up of the carbides but they remain relatively coarse and tend to be aligned in the direction of hot working.

On the other hand the alloys which are made as taught in this invention are cooled from the molten state in the form of the fine droplets (mostly less than 0.007 inch in diameter) which solidify in a fraction of a second. This extremely short time interval does not permit the carbide phase to grow appreciably.

The atomized powders are then heated for consolidation and for subsequent heat treatment of the solid stock. It should be noted that this heating is done at a temperature below that at which there is an undue coarsening or agglomeration of the carbide phase. Because of the extreme fineness of the hard carbide particles the atomized and consolidated present alloys may be hot worked at temperatures similar to or even lower than those used for conventionally produced tool steels and the alloys do not contain large carbide particles which would act as sites for crack initiation and propagation. Thus another advantage of the present alloys and the herein-described method of making them is that greater carbide volumes may be had without impairing alloy workability.

Furthermore, due to the lack of coarsened carbides the toughness of the present alloys is not impaired.

As briefly alluded to above, the atomized and consolidated alloys of my invention may be heat treated by methods commonly employed for conventional tool steels. After hot working the consolidated alloys may be annealed or softened for subsequent machining by heating to temperatures of 1500° or 1600° F. followed by slow cooling such as furnace cooling. After the appropriate finished shape has been machined from the softened stock it may then be hardened by standard commercial practices. The hardening or austenitizing is most readily accomplished by first heating the alloy to a temperature of approximately 2100° or 2200° F., holding at this temperature for sufficient length of time to permit adequate solution of carbides into the matrix, and then cooling by immersion in oil or by air cooling. Following this quenching the alloys are then tempered by reheating to a temperature near 950° to 1100° F. for one or two hours; this tempering treatment may be performed two or three times (cooling to room temperature between each heating cycle) to impart additional toughness to the alloy.

It should be noted that the heat treatments employed during annealing, austenitizing and tempering are conducted at temperatures which do not permit excessive growth or agglomeration of the carbide phase during the heating periods for such atomized and consolidated alloys.

Based upon the present invention I teach those skilled in the art that an increase of up to 100% of carbide formers plus carbon in the present alloys is readily achievable and in addition it will be noted that the vanadium content hereof may be increased by up to 600% over that normally found in M-2 high speed steels. An increase of 100% in all carbide former plus carbon approximately doubles the carbon volume in the present alloys.

While the maximum carbon content of the alloys listed in Table I is 3.4% and the desirable carbon-vanadium ratios were not attained in all cases, it is possible to add carbon up to 4.0%.

While the foregoing disclosure is directed primarily to the consolidation of prealloyed powders resulting from the atomizing process discussed in some detail above, it should be noted that other means of producing such powders may be employed. The powders must be of such a structure and composition as will yield the herein disclosed microstructures upon consolidation as taught above.

It will be understood that various modifications and variations may be effected without departing from the spirit or scope of the novel concepts of my invention.

I claim as my invention:

1. A method for producing solid iron-base alloys from prealloyed powder wherein the improvement comprises, atomizing an alloy charge consisting essentially of the following ingredients in substantially the proportions stated:

	Percent	
Cr -----	2.5 to 16	
Co -----	0 to 20	10
V -----	0.8 to 12.2	10
Mo -----	0 to 10	
W -----	0 to 20	
C -----	0.6 to 4.0	
Fe -----	¹ Balance	15

¹ Excepting for incidental impurities in trace amounts.

wherein, in terms of weight percent, the total of the molybdenum content plus one-half of the tungsten content is greater than 4 but less than 15, and where-

in the carbon content is at least sufficient to allow said alloy to be hardened to a Rockwell C value of at least 60,

rapidly quenching the atomized charge to solidify the molten particles and prevent appreciable formation

of coarse crystals of dispersed carbide phase in the resultant powder, and compressing and mechanically hot working said powder in an environment protected against admission of oxygen from outside said environment, to consolidate said powder into metal stock having a density substantially equivalent to the alloy in its cast state, said alloy metal stock being characterized by having a substantially uniformly dispersed carbide phase in a major iron-rich matrix, said carbide phase predominantly having a particle size of less than 3 microns.

2. A method for producing solid iron-base alloys from prealloyed powder wherein the improvement comprises, atomizing an alloy charge consisting essentially of the following ingredients in substantially the proportions stated:

	Percent	
Cr -----	2.5 to 16	45
Co -----	0 to 20	
V -----	0 to 12.2	
Mo -----	0 to 10	
W -----	0 to 20	
Element selected from the group consisting of Ti, Cb, Ta, Zr, Hf and mixtures thereof -----	0 to 5	50
C -----	0.6 to 4.0	
Fe -----	¹ Balance	55

¹ Excepting for incidental impurities in trace amounts.

wherein, in terms of weight percent, the total of the molybdenum content plus one-half of the tungsten content is greater than 4 but less than 15, wherein the sum of the vanadium and the element selected from said group is in the range of 0.8 to 12.2%, and wherein the carbon content is at least sufficient to allow said alloy to be hardened to a Rockwell C value of at least 60,

rapidly quenching the atomized charge to solidify the molten particles and prevent appreciable formation

of coarse crystals of dispersed carbide phase in the resultant powder, and

compressing and mechanically hot working said powder in an environment protected against admission of oxygen from outside said environment, to consolidate said powder into metal stock having a density substantially equivalent to the alloy in its cast state, said alloy metal stock being characterized by having a substantially uniformly dispersed carbide phase in a major iron-rich matrix, said carbide phase predominantly having a particle size of less than 3 microns.

3. A method for producing solid iron-base alloys characterized by a substantially uniformly dispersed carbide phase in a major iron-rich matrix, said carbide phase predominantly having a particle size of less than 3 microns, from prealloyed powders consisting essentially of the following ingredients in substantially the proportions stated:

	Percent	
Cr -----	2.5 to 16	
Co -----	0 to 20	
V -----	0.8 to 12.2	
Mo -----	0 to 10	
W -----	0 to 20	
C -----	0.6 to 4.0	
Fe -----	¹ Balance	

¹ Excepting for incidental impurities in trace amounts.

wherein, in terms of weight percent, the total of the molybdenum content plus one-half of the tungsten content is greater than 4 but less than 15, and wherein the carbon content is at least sufficient to allow said alloy to be hardened to a Rockwell C value of at least 60,

wherein the improvement comprises, preparing said prealloyed powders under conditions of production which result in the substantial elimination of the formation of coarse crystals of dispersed phases, and hot consolidating said powders in an environment protected against admission of oxygen from outside said environment, to produce a substantially fully dense material by plastic deformation.

References Cited

UNITED STATES PATENTS

3,244,506	4/1966	Reen	75—0.5
2,372,696	4/1945	Tholand	75—211
3,150,444	9/1964	Reen	29—420.5

FOREIGN PATENTS

650,555	2/1951	Great Britain	75—203
651,067	3/1951	Great Britain	75—203
668,847	3/1952	Great Britain	75—203

OTHER REFERENCES

Jones: "Fundamental Principles of Powder Metallurgy," London, 1960, pp. 29-30, 48-50.
Schwartzkopf: "Cemented Carbides," N.Y., 1960, pp. 70-71.

L. DEWAYNE RUTLEDGE, Primary Examiner

W. W. STALLARD, Assistant Examiner

U.S. Cl. X.R.

75—0.5, 213, 224, 226; 264—6, 12, 13