

Digital Word of Mouth

Alexis Baum
Chung-yi Fan
Mark Cooney
Megumi Yamashita
Woo Jin Park

WOM Indian Research

- We've devised a system that takes advantage of the WOM system. Villagers can record questions they have for the ANM, and the ANM can record her medical advice in response to villagers' health concerns
- We instructed our researcher to hand out forms that villagers would carry with them, writing names down of people they conversed with in the span of 5 hours.
- Results:
Each of the 22 forms had, on average 20, names. The village has a total population of 360, and in just 5 hours, an estimated 50-60% of villagers were involved in the process.
The paper prototype showed that WOM in the villages effectively spreads information .

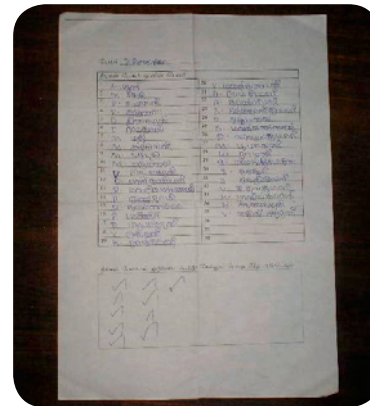
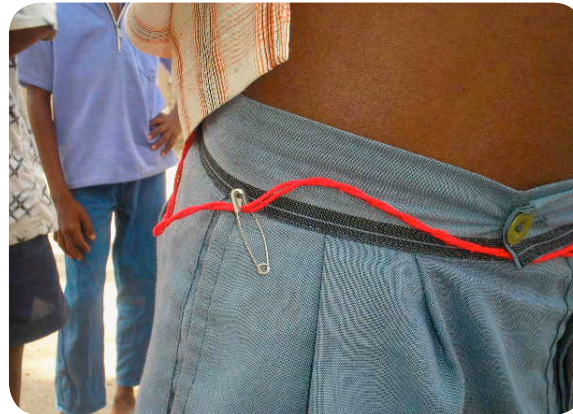

Patient to ANM

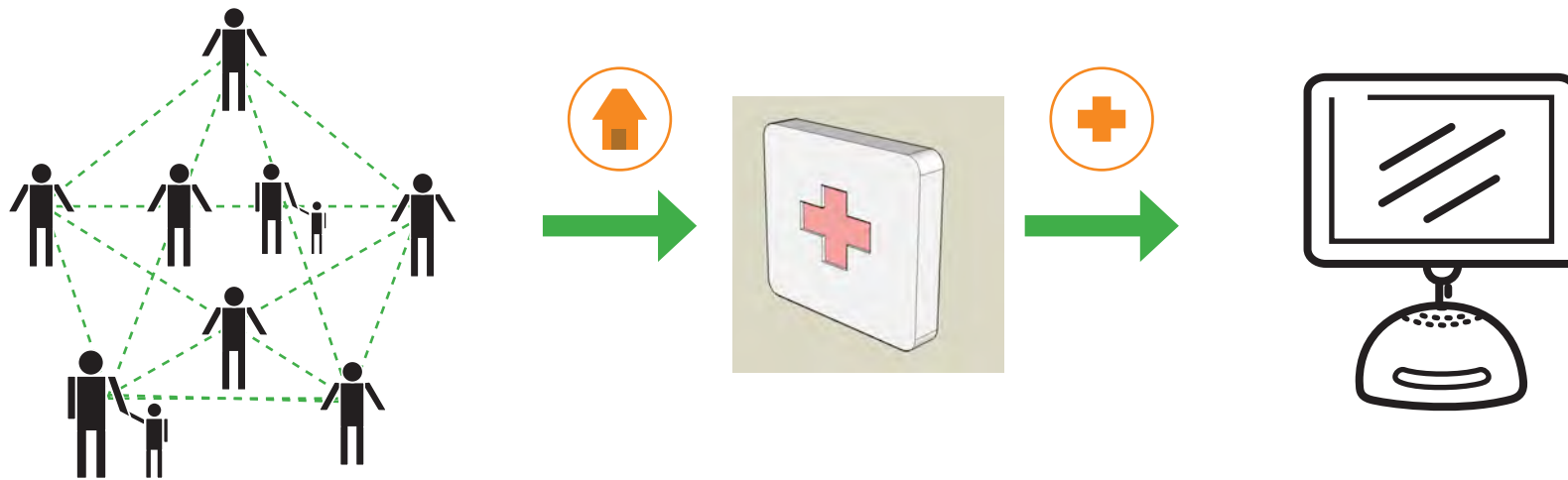

- » Every villager wears a medical pendant
- » When the villager needs medical attention or advice, s/he records her message into the pendant by pressing the record button
- » Each voice message is tagged with a unique ID that identifies the person as well as the message
- » As the sick villager passes by another villagers, the pendants swap all messages with each other
- » All cached messages have a shelf life of 5 days

- » If a villager is near a medical node to be located at a central gathering place, the pendant automatically deposits the messages it has into the node through a wireless signal

- » The ANM receives all of the voice messages through a customized dashboard that allows the ANM to listen, sort, and store the info
- » The dashboard will also filter out all duplicates

ANM to Patient

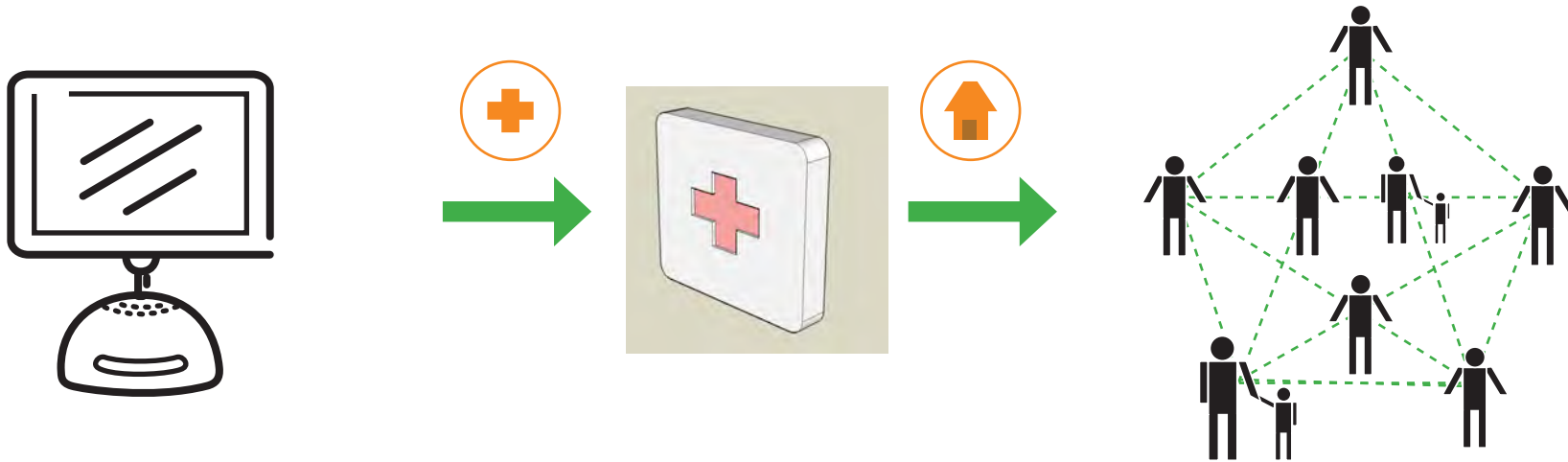

- » The ANM can respond to specific patients or broadcast a mass message by recording a message into the dashboard
- » The message is then sent to the medical node located in the village

- » The medical node receives the ANM message and broadcasts to any villager near the node that has a pendant

- » As each villager passes other villagers, every message is passed
- » If the unique ID on the message header matches the unique address of a pendant, the pendant automatically flashes to let the villager know that s/he has a message for him/her
- » Villager presses the play button to listen to their message
- » All cached messages have a shelf life of 5 days



Healthcare for Rural India

IIT Institute of Design / IPRO 304 / Spring 2007

Cheek / Madraswala / Rivera-Pierola / Sitthisathainchai / Ward

Concept I:
Solar Health Lantern

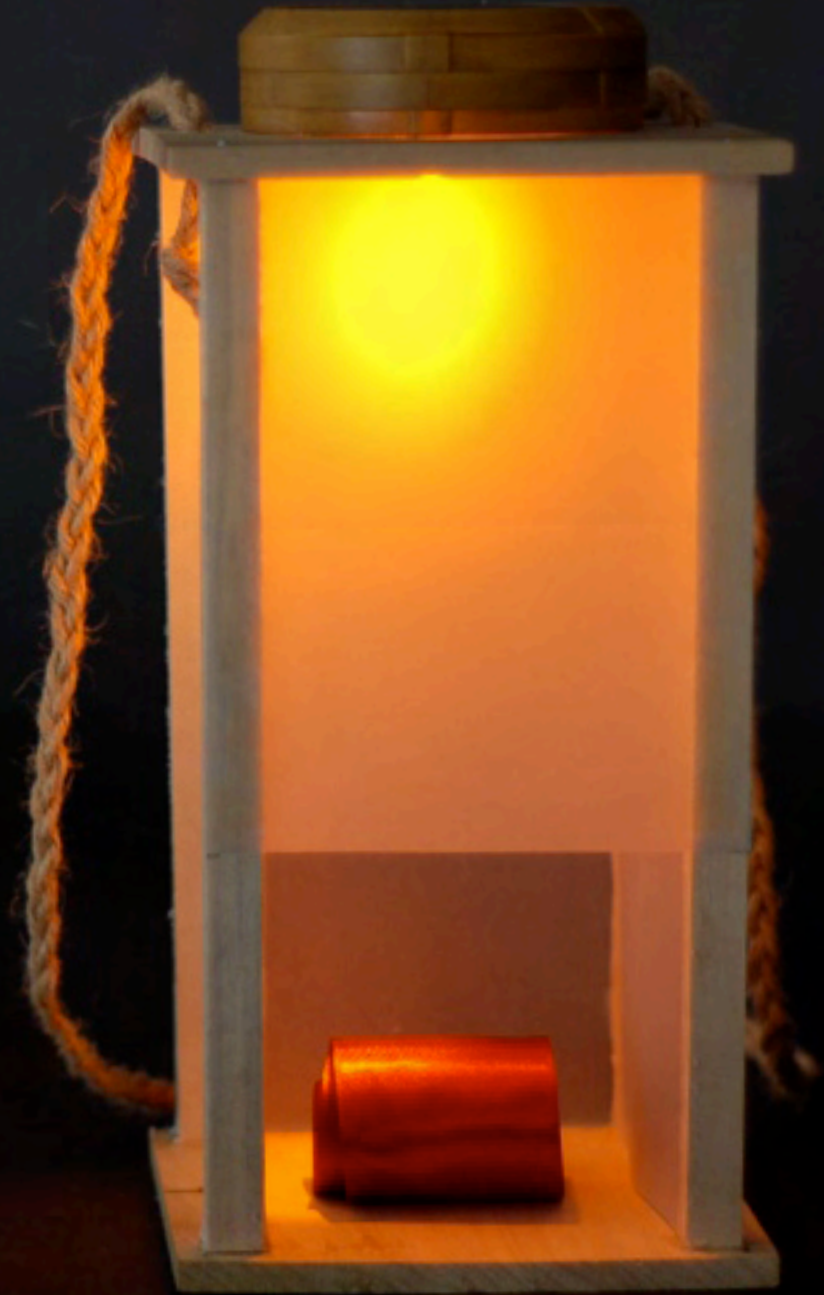



ANM's write visit information directly on wall.

No way for patients to signal for need.

ANM's only visit village once a week.

Messaging problem



Household level records incorporated into health beacon.

Concept 2:
CharmAlarm



I walked all the way here, now I have to wait for four hours.

visually coded with time interval grooves

narrow grooves = 2 wks —

wide grooves = 6 wks ■

time sensitive color change ink

living hinge

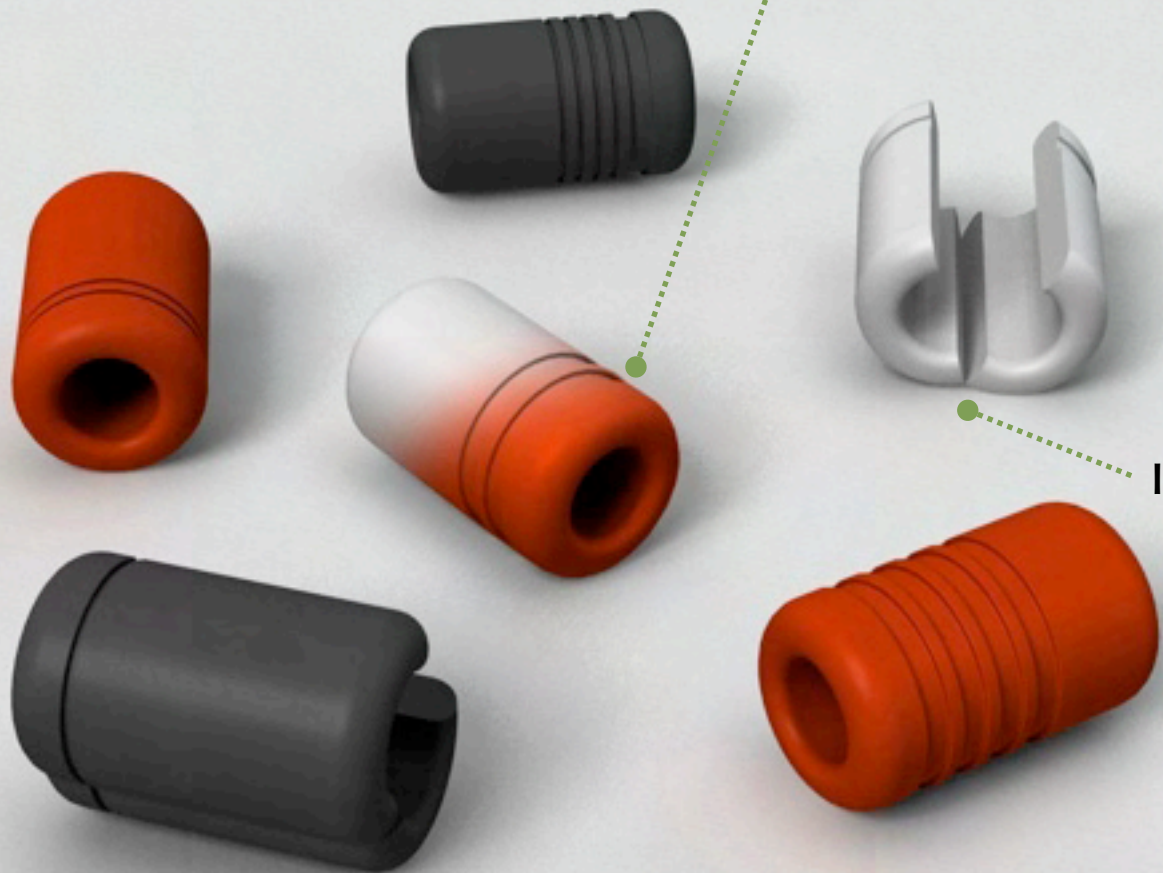

Healthcare in Rural India

Initial Concepts

Maura Collins
Asha Joseph
Dan O'Brien
Marieke Smets





Problem Exploration :: Research Findings



What are the issues and why is it a problem?

It takes people an entire day to go to the PHC; Going means giving up a day's wages and waiting in long time-consuming lines that could result in the discovery that the visit was unnecessary; This often causes patients to postpone doctor's visits until the health issue becomes severe.

What can we do to help?

How can we motivate patients to both regularly visit the doctor for checkups and seek immediate medical attention when necessary? How can we make the doctor's visit, particularly waiting in line, more efficient?



Concept 1 :: Return Visit Incentive

In order to motivate patients to both regularly visit the doctor for checkups and seek immediate medical attention when necessary, we developed the Return Visit Incentive Concept.

Multiple Visit Savings Account

Patient pays an additional two or three rupees for their doctor visit each time they go. When an emergency arises, or when personal finances are tight, that money is used to cover their visit.

Reimbursement as a Phone Call, Bus Ride, Free Visit

After seeing the doctor, you are told that you have to come in for a follow-up visit in one week. The doctor understands how hard it is for you to travel all this way to see him and he offers you an incentive to return.



Multiple Visit Savings Account



Travel reimbursement (fuel, a coin for return bus trip)



Phone time on the phone at the doctor's office



A free visit to the doctor, after a set number of return visits.



* Photos from field visits by Nakul



Concept 2 :: Diagnose in Line

In order to make the doctor's visit more efficient Diagnose in Line helps to collect basic patient health information. While waiting in line, patient's can individually, or with assistance, record this information.

This decreases the workload for the doctor, and makes the time waiting in line productive.

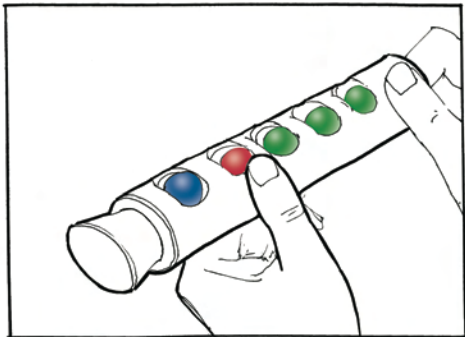

BEAD TWIST

4-07

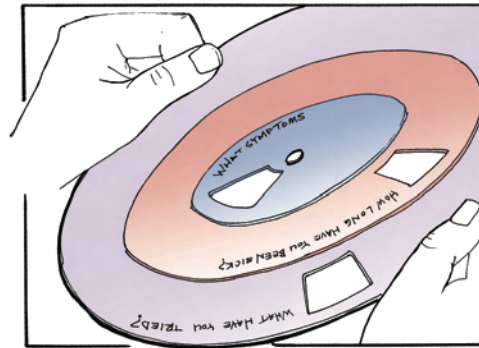

INFO WHEEL

4-07

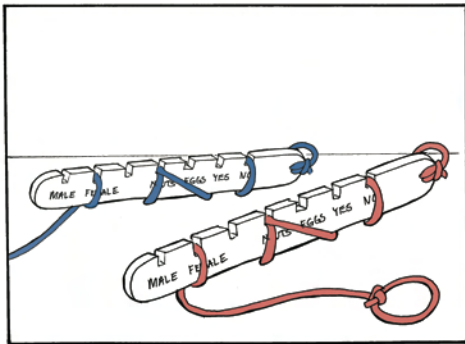

INFO STICK

4-07

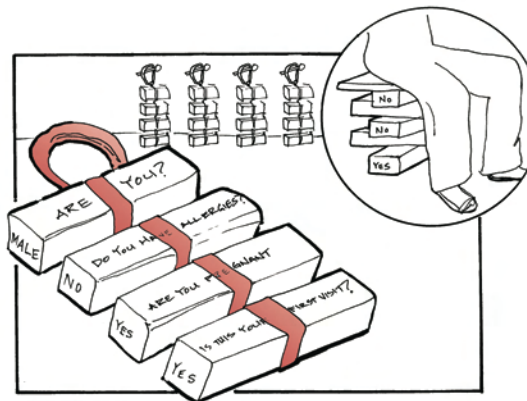

SIT-IN-LINE

4-07



Healthcare in Rural India
Health Stop

John Ekholm, Pushkar Vichare, Syed Khan, Taeho Wang

*Product Design Workshop
Spring, 2007*



Health Stop

Insights/problems



- Current methods of disseminating health and hygiene information are limited.
- Many villages have no structure dedicated to healthcare.
- Patients rarely have a means of transportation to the local clinic.

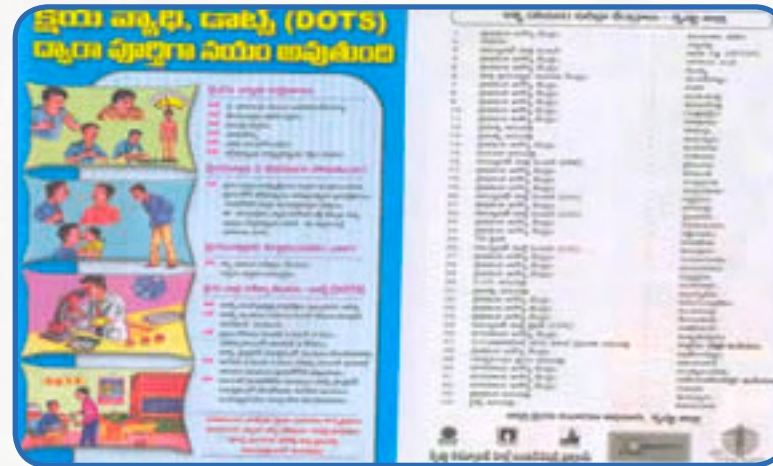

Health Stop

Concept

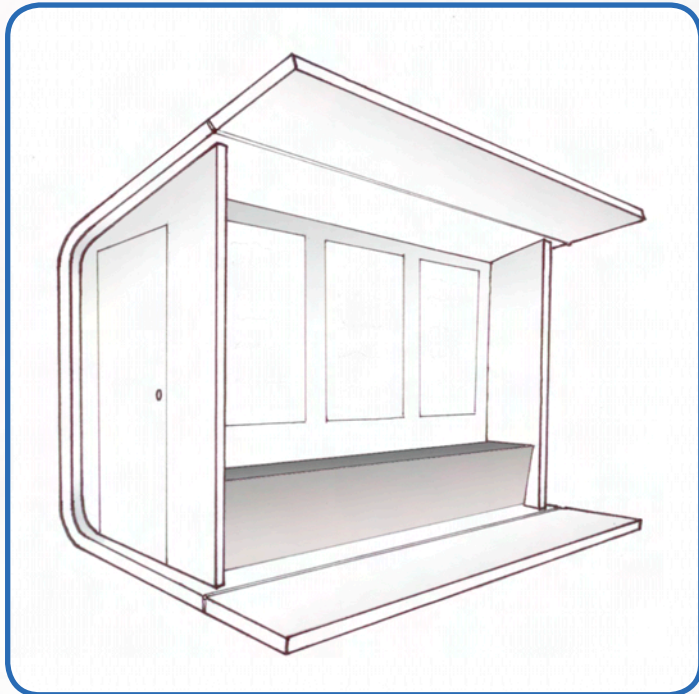

- The “Health Stop” would serve as a meeting place for health related matters.
- Health information and advisories could be posted at the health stop.
- Patients seeking transportation to the local PHC, and those who can offer transportation could use the health stop as a meeting place.
- ANM’s could use the health stop as a base of operations within each village.

Healthstop - Overview

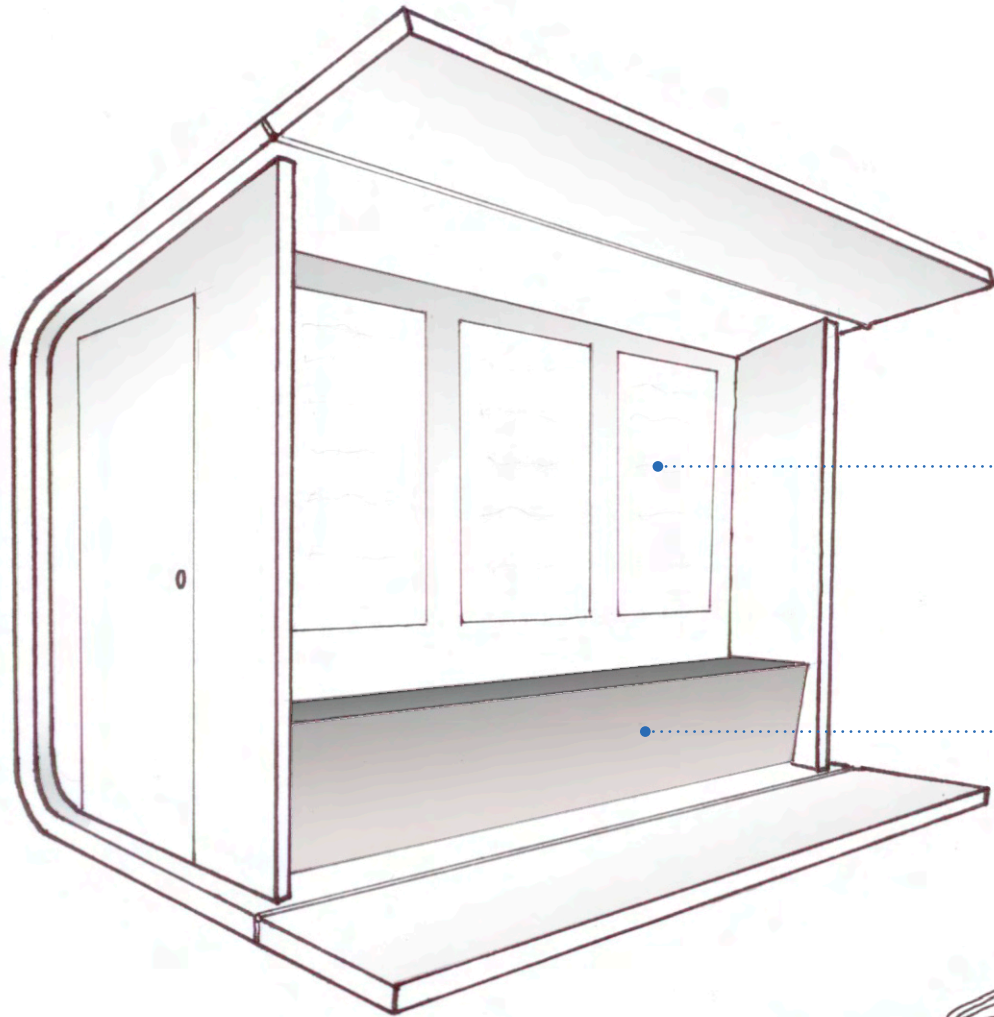

Area for posters with health-related information

Bench for waiting (for ride or to make a call)

Easy delivery

Easy installation

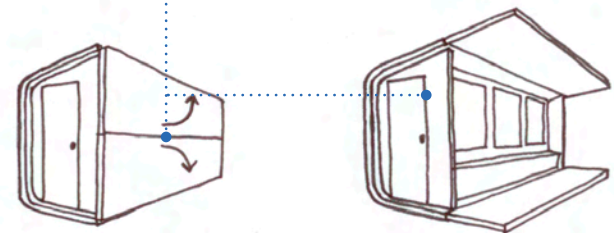
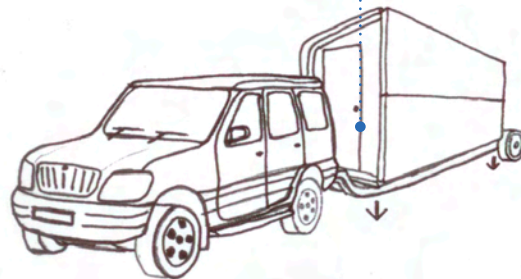

Healthstop - Details

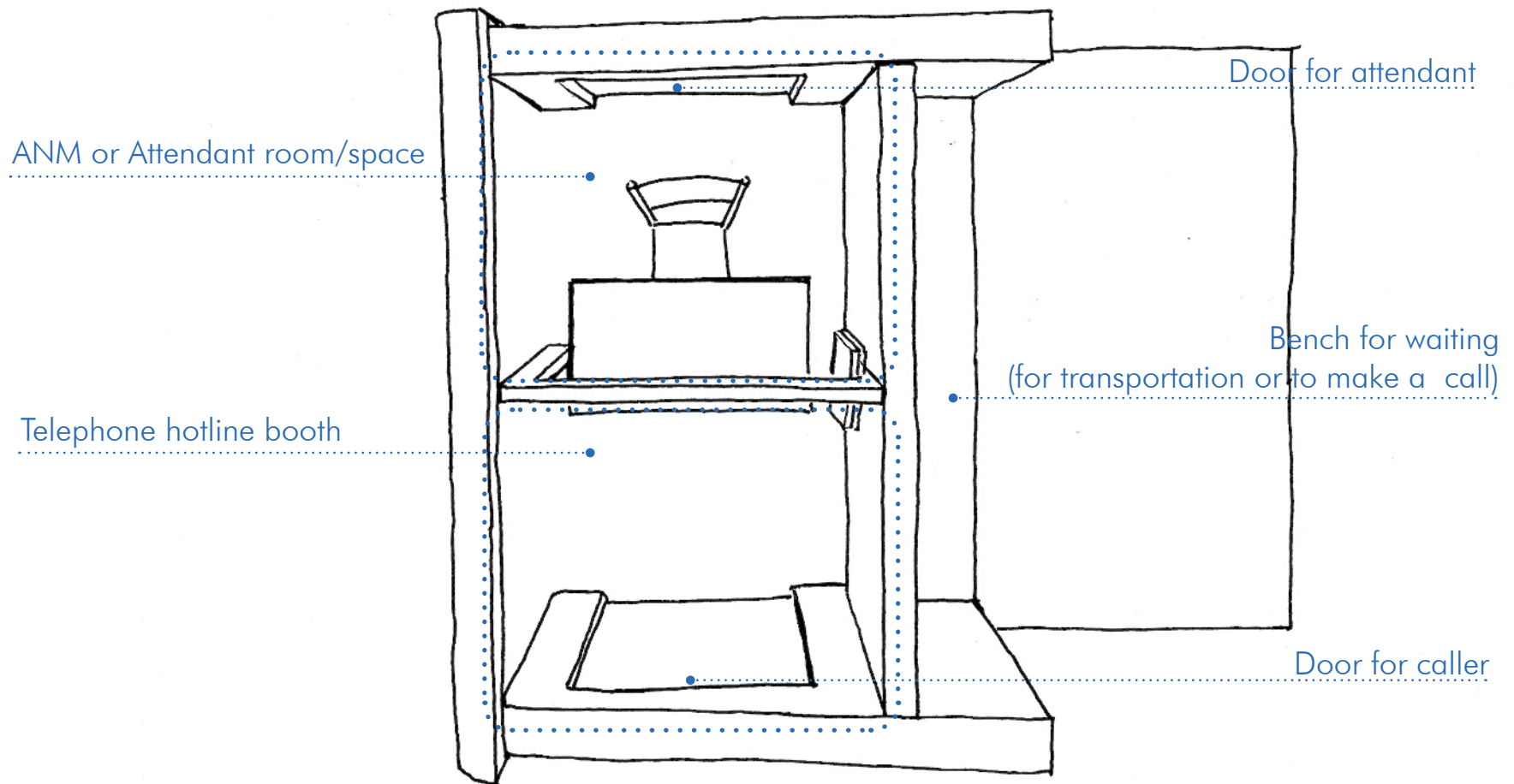

Healthstop - Prototype

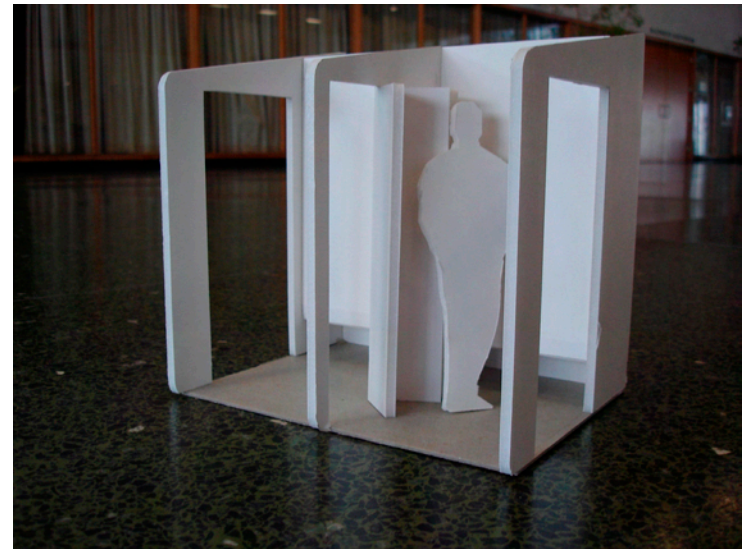
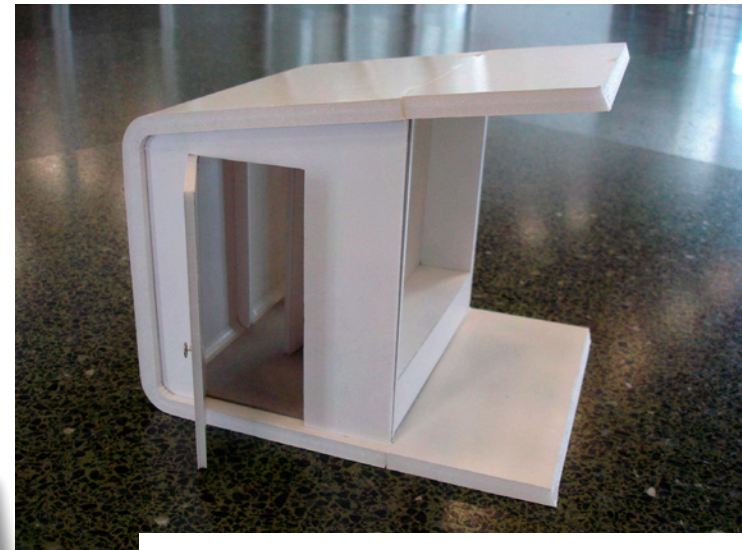

THE DISTRIBUTION OF MEDICINE IN INDIA

Introduction | Opportunity Space

Bulk medicine storage

Medicine disorganization during daily use

Mistakes are made dispensing medicine

Packaging re-use and disposal



Concept | Individual Mobile Medicine Package

Diverse set of common medications in a single package

Package designed to be carried by a single individual

Package fits in motorcycle saddle bags

Provides compartments to store waste products for later disposal

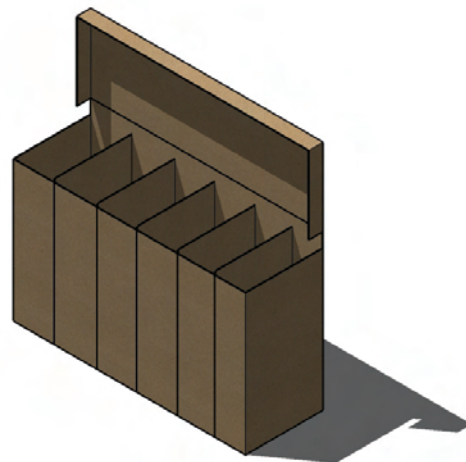

Concept | Second Life Use

Trump Cards improve perception and awareness

A tray can be used for additional storage

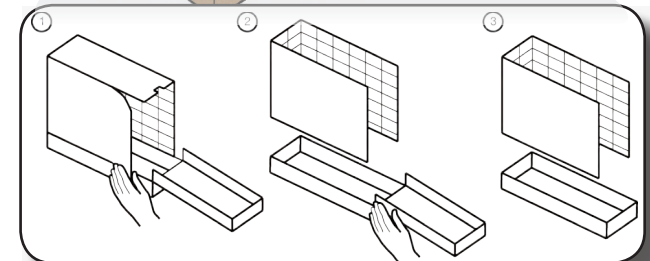
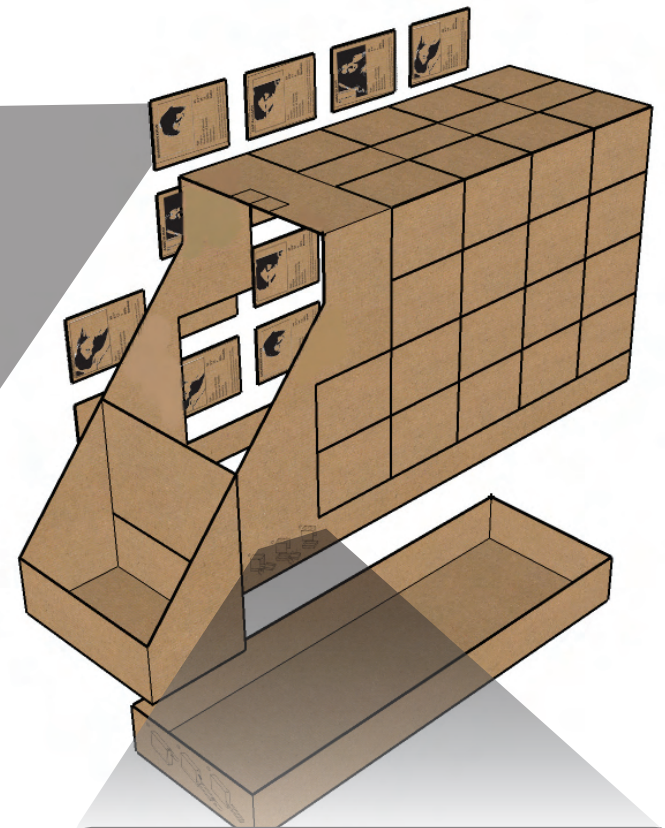
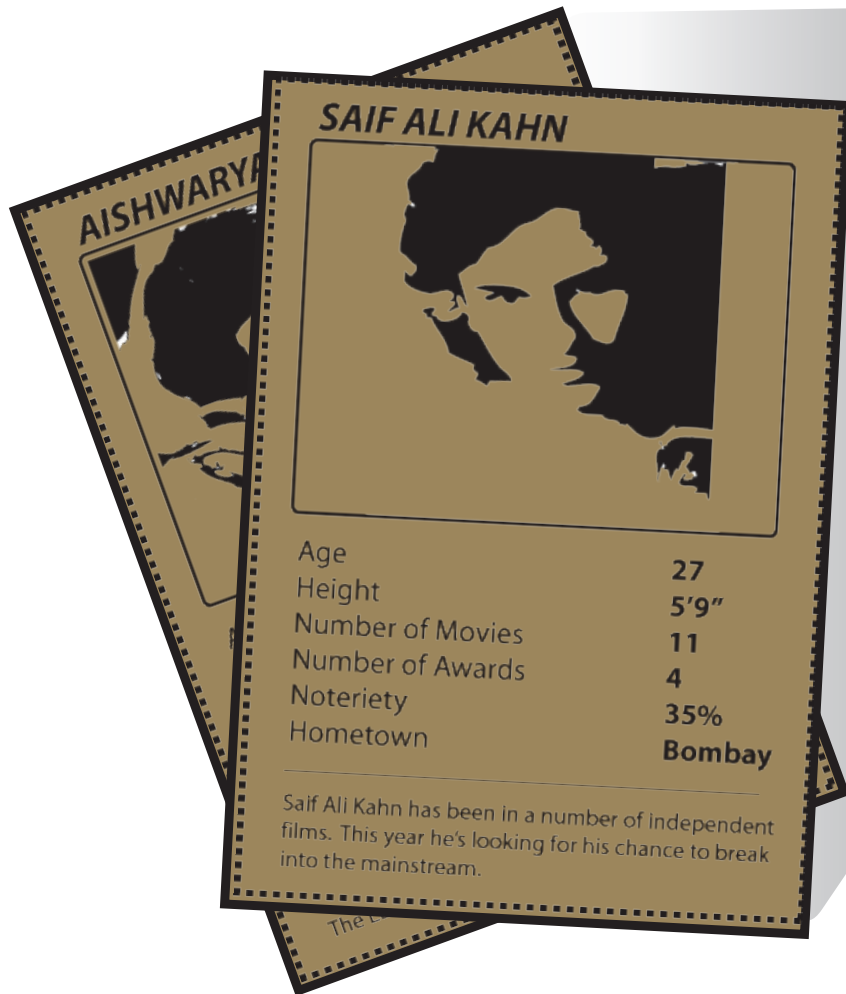

Concept | Tabletop Medicine Organizer

Provides easy layout for organizing med bottles throughout the day

Reduces errors by letting users individually develop organization schemes

Closes for easy storage at night

