

IPRO 350
Smart Specs
Fall 2009
FINAL REPORT

Table of Contents

Executive Summary	4
Analysis and Conclusion	4
Recommendations	5
Appendix 1: Team Information	6
Appendix 2: Expenses	6
Appendix 3: Business Plan Concept	7
1. The Problem	8
2. The Solution	8
3. Real Time Initiative LLC	8
4. Product Details	8
5. Value Proposition	9
6. Target Market	9
7. How to reach markets	12
8. Distribution Channels	14
9. Market Strategy	14
10. References	16
Appendix 4: Technical Team Semester Report	18
1. Objective of this document	19
2. Background	19
2.1. Initial idea	19
2.2. Background Research	20
3. The final product	23
3.1. Brief description of the product	23
3.2. Design requirements	24
3. The prototype	25
3.1. Objective of the prototype	25
3.2. Hardware	26
3.2.1. Arduino	26
3.2.2. Compass	27
3.2.3. Wireless	28
3.2.4. GPS	29
3.3. Software abstract	30
3.4. Stage of the prototype	31
3.5. Future modifications to the prototype	31
4. Future developments of the product	32
References	33

Appendix 5: Survey Response..... 37
Appendix 6: Prototype Code..... 42
 1. Headset Application..... 42
 2. Desktop Application 48

Executive Summary

In the real world, receiving the right information at the right time exacts success or failure. In the growing sport of paintball, every little edge counts towards victory. Real Time Initiative offers Smart Specs to our consumers to obtain an edge over the competition.

Smart Specs relay real-time networked information amongst the users to distinguish friends from foes. The communication occurs through head mounted displays worn within the paintball masks. It reduces friendly fire which in turn reduces tension within the team.

The technology integrates various individual technologies like GPS, compasses and range finders into one single optical device. Over time, this technology will become a base platform that can be improved upon or integrated for other purposes.

Within the U.S. paintball industry, a \$400 million market grows at an average of 16.8% per year. Over 9.4 million paintball players participate within the U.S. Out of the paintball market, three segments exist; recreational, tournament, and scenario. Out of those segments Real Time Initiative will be targeting recreational and scenario paintball market.

Viable markets exist for Smart Specs to grow and control within. On the technical side, the technology to create such a product lays within our grasp. An early prototype confirms a proof of concept of this product. With time, this technology can grow and dominate the paintball market and spread to other industries.

Analysis and Conclusion

A viable market exists for the technology and product that we are creating. We believe the Scenario and Recreational segment of the paintball market provide a sustainable market for our product. With further expansion upon the products and technology, the business can expand into other industries that pertain to the head mounted display technology.

The prototype that was built, demonstrates a proof of concept. With better resources and more time, the prototype can be taken to the next level. The next stage of the prototype is to create something that more resembles the final product. Knowing specific unit information will provide definitive financial data.

Recommendations

Build another prototype that better reflects the final product. The more final the design is, the more leverage the team will have determining unit production costs and profit margin.

Look into the Airsoft industry. Fall 09 was unable to find substantial market information on the Airsoft industry, as it is fairly disorganized; however we do know Airsoft is a healthy growing industry, and we fully believe Airsoft would be viable market for Smart Specs in the future.

Future teams are highly recommended to work with or be advised by a design & manufacturing firm in order to see what steps will be further involved in getting to the final product so that it can be manufactured on a large scale. Miniaturization of the circuit and cad designs of the final prototype will be some of the key undertakings of future IPRO teams.

The technical team also might want to look into the potential of a Local Positioning System (LPS) which will drastically help enhance the accuracy of the product. The use of LPS was proposed at the end of the current semester and needs further introspection.

Looking into the various aspects of manufacturability and pricing will be important for the business team to look into. A detailed revenue structure needs to be worked out on the business side of this project. It will also be essential to identify the right manufacturer or company to transfer on the project to and determine an appropriate distributor for the final product.

As for business research, the team needs to continue talking to paintball players and paintball field owners to better determine what they think about the product, and how willing are they to buy it and what should be a good pricing for the product.

Exploring future markets and the methods to penetrate potential future markets should be one of the major undertakings of the upcoming IPRO teams. Coming up with a strategy to make the business more sustainable will be quite important.

Appendix 1: Team Information

Instructor: Jim Braband braband@iit.edu
 Al Glodowski glodowski@iit.edu

Bubert, Casey	cbubert@iit.edu	Comp Sci
Fairall, Earl	efairall@iit.edu	Aero/Mech
Hopkins, Dong	dhopkin1@iit.edu	Business
Hutchins, Sarah	shutchi1@iit.edu	Elec/Comp
Kobayashi, Jonathan	jkobaya1@iit.edu	Electrical
McCluskey, John	jmclusk@iit.edu	Mechanical
Pain, Muhammad	mpain@iit.edu	Electrical
Patel, Purvag	ppate29@iit.edu	Mechanical
Roa, Carlos	croa1@iit.edu	Mechanical
Spitler, Noah	nspitler@iit.edu	Aerospace

Appendix 2: Expenses

Component Name	Quantity	Unit Price	Subtotal
Arduino USB Board	2	29.95	59.9
20 Channel EM-406A SiRF III Receiver with Antenna	1	59.95	59.95
Xbee 1mW Chip Antenna	2	22.95	45.9
Compass Module HMC6352	1	59.95	59.95
Arduino Xbee Shield	2	24	48
HMC6343 Digital Compass	1	149.95	149.95
Logic Level Converter	2	1.95	3.9
Arduino Stackable Header 6-pin	6	0.5	3
RJ45 Ethernet MagJack	2	1.95	3.9
RJ45 Ethernet MagJack Breakout	2	0.95	1.9
Shipping			25.03
TOTAL			461.38

The team requested a general \$700 for their budget this semester. We requested \$600 for electrical components, and \$100 for external enclosure. We fabricated the enclosure from left over material, so it did not cost the team. \$461.38 was spent on electrical components. Project goals changed throughout the semester, and hence we ended up not needing the left over \$238.62.

IPRO 350: Smart Specs
Fall 2009
Appendix 3: Business Plan Concept

1. The Problem

On the paintball field there is no technology that helps a paintball player differentiate between friend and foe. Current technology does not provide an efficient platform for object visual identification, navigation, or team communication. Current positional technology requires the user to operate several separate hand held devices to determine the user's spatial coordinates, direction, and distance from a point of interest. To communicate these details to others requires that the user must translate the directional and spatial information through a communication device such as a phone or radio. The steps involved to determine and communicate location are currently a very time consuming process. This lapse in communication and the current limitations of handheld technologies often makes it difficult for troops and paintball players to distinguish between their teammates and enemies. This confusion results in friendly fire and fratricide.

2. The Solution

To reduce the chances of friendly fire, our product Smart Specs is a head-mounted platform that aids in visual object identification and team communication. Smart Specs displays positional information in the user's regular field of view, allowing the user to keep focus on their surroundings and environment. Further Smart Specs provides positional information to all team members for simultaneous team position awareness. This information gives the user real-time identification of teammates through HMD (head-mounted display) technology. On the battlefield, distinguishing between teammates and enemies will reduce the chances of friendly fire and optimize team co-ordination.

3. Real Time Initiative LLC

The company introduces Smart Specs and its associated accessories pertaining to quick visual communications. Real Time Initiative is dedicated to providing products that can convey pertinent information in a timely and efficient manner. The company is dedicated to providing quality products to give the users an edge over the competition.

4. Product Details

Smart Specs is a revolutionary design that integrates team spatial information into a head mounted display. The device is worn as glasses or goggles, and has real-time information displayed in the user's normal field of vision. The display shows markers where a specific coordinate would be (i.e. a spatial representation of a person on your team), relative to the user's position and current field of view. As the user moves his or her head, the point moves relatively to designate where that point of interest is, in relation to the user. The point lights up on the goggles and a small indicator, but does not obstruct the user's vision of their surroundings. The purpose is to augment the user's normal field

of view with important information. For future products, Smart Specs will include tags of specific interest points, and will display heading and range, in relation to the user's position. This information will be shared among multiple users' devices. This allows all users to see these interest points, relative to their individual position

Keeping the above usage in mind, there are two product designs currently on the table. The first would be integrating the technology into a paintball mask with a protective disposable lens layer. The second would be smart specs augmentation kit with protective lens layer that attaches to paintball masks.

5. Value Proposition

What's in it for the Customers

Smart Specs benefits the user in several ways. To begin with, Smart Specs will reduce unintentional friendly fire of the product users. To the user, this means more markers pointed at the competition. Reduction of friendly fire will also reduce the quantity of paintballs being used, which equates to money saved for the user. In addition to the reduction of friendly fire is the explicit knowledge of teammate's position. This provides strategic advantages to the user's team.

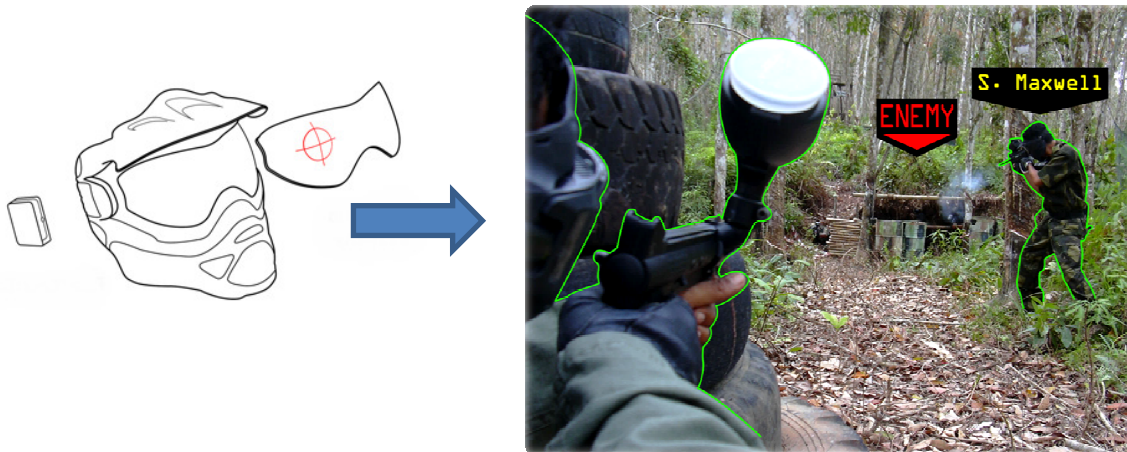

6. Target Market

The main market for this product is currently the paintball industry. Market research has shown that Paintball is the number one growing sport in the U.S.. In the last 5 years, numbers playing the sport has grown over 84% raising the total number of players up to 9.4 million. Paintball has more than 11,600,000 players worldwide. 1.4 million of these players play over 15 times a year. In 2008, over \$720 million were spent on paintball equipment. Operational investigation of the sport itself uncovered three main segments within the paintball industry, recreational, scenario, and tournament. [1]

Tournament Segment

Tournament paintball is an individual or group of people who play competitively. These events are sometimes sponsored. At large events, the winners may receive prize gifts or sponsorships. Tournament play is usually regulated with rules, regulations, and a referee staff.

The Tournament segment of the paintball market was quickly ruled out after a short discussion, as typical rules and regulations would not allow a product such as smart specs.



Figure 1. depicts the beginning of a tournament paintball match. Electronics are not allowed in typical tournament paintball tournaments. [2]

Recreational Segment

Recreational paintball defines the group of people who play paintball in their spare time without any real reason other than fun and enjoyment. These players would not consider themselves “pros”. These players more will not own high quality equipment, if they own their own equipment at all. These players will rent their equipment from the attended paintball field.

Recreational paintball is thought to be a possible market for Smart Specs. Due to this segment’s lower disposable income and non-fanatical interests, recreational paintball players are less likely to purchase this product. Smart Specs may be able to generate revenue by having players rent Smart Specs from paintball fields and selling warranty plans for the product.



Figure 2. Depicts two recreational players guarding entranceways. [3]

Scenario Segment

Scenario paintball is match style designed to replicate a historic battle or reproduce possible battle scenarios. This segment spends large amounts of money to become a weekend warrior. They purchase products that provide a competitive advantage or a realistic looking item. For these people, scenario paintball is a hobby, and not a recreational activity. They are also early adopters to new products.



Figure 3. Depicts a scenario player in an extravagantly realistic uniform. [4]

Scenario Paintball is believed to be Smart Specs' strongest market in the paintball industry. Given a scenario paintball player's competitive nature and lack of competitive rules, it is believed Smart Specs may be welcomed in this sector.

7. How to reach markets

We have discussed four ways in which we can reach our target market.

- Websites
- Bloggers
- Magazines
- Demonstrations

Websites

We chose websites as a method of reaching our market, because a website is a fairly inexpensive way to promote our product. If it is promoted through select websites that deal with paintballing, it will allow us to directly reach our target segment.

The following websites can be utilized to market Smart Specs and reach target markets:

- Paintball Guns Online Store: <http://www.paintballguns.net/>
 - Paintball Equipment can be purchased and rated on this site
- The Paintball Blog: <http://www.thepaintballblog.com/>
 - Information on products and reviews
 - Paintball Tournaments and Events
 - Videos to get to know the Game better

Along this subject, we have already created our own first start on a website. It includes our product information as well as contact information. A final website would include product information, purchasing options, visuals, and contact information.

Bloggers

On the internet, certain well respected critics have valued opinions which have significant impact on communities and their perception. Negative opinions will lower the success rate of the product while praises will exalt the product within the community. Once we have a provisional patent filed for we intend to put up a product review page on the blogs where bloggers can send in what they would want to see in the product and we can try an improvise accordingly making it even more marketable.

The following bloggers influence possible consumer purchases

- Paintball Buyer's Blog: <http://blog.paintball-online.com/> [5]
 - Contains Advice and Reviews of Paintball Products
- Sniper Paintball Blog: <http://sniperpaintballblog.com/> [6]

- Contains Tips on products and how to upgrade equipment
- Paintball Tips and Tricks:
 - <http://www.paintball-tips-and-tricks.com/paintball-blog.html> [7]
 - Contains Tips to players on the game and products

Magazines

Paintball magazines are viewed by our target market. The magazine could provide visuals and promotional information about the product. If the product is covered by the magazine itself, it will ensure a positive opinion from the community. Magazine ads are expensive; however magazines likely offer the most direct communication to the consumers of interest.

Possible magazines include the following:

- Paintball 2Xtremes
 - Subscription magazine
 - Covers Pro and Amateur Tournaments and Scenario Games
- Wired Magazine
 - Tech magazine
 - Promotes the technology and spreads the word
 - A way to expand into other sectors
- Action Pursuit Games
 - Subscription magazine
 - Targets Paintball Enthusiasts
 - Covers New Products
 - Covers Tournaments and Prominent Players

Demonstrations

Going to scenario events and demonstrating the products or allowing a team to use the product during an event. Their opinion would significantly impact the community, while increasing the interest of our product. This would inform the community that our product exists and provides first hand experience. This would also further increase our reach of the target segment through word of mouth.

The following locations and events can be utilized to promote Smart Specs

- Battle Front Paintball Field
 - Promotes Scenario Paintball
 - Located in Hubbard, Ohio (NE Ohio)
- Tactical Paintball: <http://www.tacticalpaintball.com/> [8]
 - Holds scenario paintball events
 - Forum support to players and teams
- Myrtle Beach Paintball: <http://www.adventurebeachscenariopaintball.com/> [9]
 - Holds events in Paintball and Airsoft

8. Distribution Channels

To define the image of the company and its products, Smart Specs would have to be sold through specific channels. Certain channels wouldn't reach the chosen target segment while others would tarnish the product image.

Company Website

The company website will set the tone and image of the company and its products. It will provide product information and a way to contact the company. A sales system would be set in place to relay transactions. On the negative side, unless an individual knows about the company/products, the consumer wouldn't reach the website.

Specialty Shops

Stores specializing in paintball would allow our company to target the paintball market without additional usage of funds for advertisements. These stores hold a wide range of paintball products that range from high end to low end. Workers would know about equipment and would provide valuable information to the consumers.

Paintball Fields

A wide range of players visit the fields for events and recreation. The fields not only provide purchasable gear but rental equipment. It's a perfect place to promote and demonstrate the capabilities of Smart Specs. The fields can rent out and sell the Real Time Initiative products.

9. Market Strategy

Variety of ways can be applied to attain revenue while reducing costs for Real Time Initiative. The following strategies cover ways for the company to minimize costs and to increase the means to capture capital.

Product Versions

Different versions of the Smart Specs would be created to cater to the needs of the consumer.

Version 1

A paintball mask integrated with the Smart Specs would be created. This version provides the convenience of a ready to use product. A consumer can buy it off the shelf and use it without any technical work. Although this would cost more to the consumers, the extra cost pays for the convenience. It also comes with several transmitter beacons for team mates to use in case others don't own Smart Specs.

Version 2

The targeted consumer owns paintball equipment which they favor. The owned equipment may cost large sums. A high quality mask can cost up to \$200. In providing Smart Specs as a kit, it allows the consumer to attach the product into the existing mask. The integration kit provides the main Smart Specs with a protective disposable lens and transmitter beacons. This kit would be lower in cost to the Version 1 of the product.

Sales of Accessories

Disposable Protective Lens

Over time, the lens that cover and protect the eyes and the Smart Specs would wear and tear. This would cause problems for the users. After a certain amount of usage, the consumer can replace the old ones with the new lens. Due to the fact that we produce the lens to complement the Smart Specs, it would provide consumer satisfaction through the ease of replacing the lens. This would be similar to the razor and razor blade model.

Transmitter Beacons

For Smart Specs to function, it needs a way to identify allies from enemies. A Smart Specs product identifies and communicates with other Smart Specs. If teammates don't own a pair, the teammates will not be able to be identified by a Smart Specs user. Furthermore, the teammates may not be able to afford the Smart Specs. In providing a cheap alternative, it'll increase the effectiveness of the product. The transmitter beacon would allow the product to identify allies within the paintball match without the use of another Smart Specs. It provides the company with another product to sell to consumers while maintaining their satisfaction with the product.

Product Rental

Smart Specs can be sold to the owners of the paintball fields or loaned out to them. At the paintball field, the Smart Specs can be rented out to the recreational paintball players at a fraction of the cost of owning it. This would provide opportunities to the potential consumers to evaluate the product. Their satisfaction can promote the product through word of mouth. If the Smart Specs is loaned out to the owners of the paintball field, it would boost the sales of protective lens and the transmitter beacons. Handing the product over for use would start a relationship between the company and the potential long term partner.

Alliance Creation

Several different alliances can be created amongst the company involved in the whole process of manufacturing, distribution and service.

Manufacturing

Under manufacturing, an alliance can be made with existing firms involved in paintball masks. This alliance provides brand recognition with connections to the manufacturers. It would allow the company to piggy back off of existing brands names and manufacturing

process. This reduces the cost on our part due to out sourcing production and manufacturing while reducing cost of promoting the Smart Specs product.

Distribution

Partnership with shipping companies would lower costs to the company through discounts and long term contracts. The partnership can be created to UPS or FedEx to reduce costs in shipping. This can range from shipping costs to materials to be used to package the products to be processed and transported.

10. References

- [1] <http://www.nsga.org/i4a/pages/index.cfm?pageid=1> (N. Spitler)
- [2] <http://www.paintball-guns-equipment.com/what-is-speedball-paintball> (D. Hopkins)
- [3] <http://forum.specialopspaintball.com/index.php?showtopic=137930> (D. Hopkins)
- [4] <http://www.scenariopaintball.net/> (D. Hopkins)
- [5] Paintball Buyer's Blog: <http://blog.paintball-online.com/> (D. Hopkins)
- [6] Sniper Paintball Blog: <http://sniperpaintballblog.com/> (D. Hopkins)
- [7] Paintball Tips and Tricks: <http://www.paintball-tips-and-tricks.com/paintball-blog.html> (D Hopkins)
- [8] Tactical Paintball: <http://www.tacticalpaintball.com/> (D. Hopkins)
- [9] Myrtle Beach Paintball: <http://www.adventurebeachscenariopaintball.com/> (D. Hopkins)

THIS PAGE INTENTIONALLY LEFT BLANK

EnPRO 350: Smart Specs
Appendix 4: Technical Team Semester Report

CONFIDENTIAL

1. Objective of this document

The objective of this document is to clearly outline the technical advances that the team achieved during the semester. The ideas in which the project is based are presented first, to give a background of the problem we are trying to solve. The relevant ideas from the market research are then presented to give an insight of our approach during the first weeks. After that, a description of the final product, including the application, some design requirements and possible graphical representations of the product are shown. This is intended to give an idea of the final objective of the team regarding the product itself. These ideas are meant to be modified as the project advances, in order to be in accordance with the business plan and the upcoming developments. The next part describes the prototype in as much detail as possible. It states the objective of the prototype and includes hardware and software specifications. The last part gives ideas regarding future developments of the product resulting from the research and advances done during the semester.

2. Background

2.1. Initial idea

Smart Binoculars began as an EnPRO focusing on automation of traditional site seeing binoculars and applying the technology developed to its military counterpart, the 'smart binoculars'. Conventional sightseeing binoculars have several shortcomings which the EnPRO was supposed to overcome by automating it through the use of robotics.

Integration of interactive touch screen technology and GIS (Geographical Information System) layer into such binoculars would be one of the undertakings; however, the prime focus of the EnPRO was developing this technology further for military application. The proposed military version of these binoculars, called 'smart binoculars', is a ground based tracking system for border patrol and other security applications. It is formed of an array of self sustained digital binocular units mounted on top of tall towers or suspended from blimps or helium balloons. These binoculars have longer range of sight than traditional surveillance cameras and are networked wirelessly amongst each other. They can track an object across the array, so when an object (car, person, etc.) moves out of the range of one binocular the consecutive one takes over. The primary advantage of this type of surveillance system over air patrol is that it provides continuous tracking and surveillance over an area (even when there is no air patrol hovering over that spot) until intercepting forces stop suspicious activities. The military application is tentative and is still open to interpretation and modifications and might be directed as the EnPRO team decides to take the concept further.

Upon researching surveillance technology, evidence was found that similar cameras and binoculars using robotics exist. The idea to have a dynamic interface emerged from the initial functions of tracking and GPS in a first-person viewing platform. It transitioned to

having a device that could be used like binoculars that have a GPS system to track the position of friendly forces and specific designated points. Further, the idea of having the interface worn as glasses or goggles on the head would allow this information to be available at all times. This capability would allow the user to track other people and points of interest while having the hands free for other functions. This idea was taken from several first-person shooter video games, in which the user's field of view has a head-mounted display with navigation and tracking information. Some games currently using these technologies are Halo, Call of Duty, and Counter-Strike.

Thus, the idea of Smart Specs replaced Smart Binoculars. This product offers a hands-free HMD (Head-mounted Display) for military troops to use in combat. They could track their allies and have tags in their field of view to designate who is friend and who is foe. This would eliminate friendly fire and casualties and allow the troops to have navigation information without taking their hands off of their weapon and their eyes off of the battlefield.

Advice from a former military member led us to the conclusion that the military would be a tough consumer to target and that we would need to find a different niche market at the beginning. Paintball, which is a popular game simulating real-world combat, was the obvious choice. Paintball is played out similar to a firefight would be on a battlefield and the same problems and needs exist for the players. By integrating our technology into a paintball mask, we could offer paintball players the ability to track their teammates in a HMD.

2.2. Background Research

During the first two weeks of the semester each member of the team researched a field related to the idea of the Smart Binoculars to gain insight in the topic. The following are the most relevant excerpts from this research.

One member of the team researched Unmanned Aerial Vehicles (UAV) and Networked Surveillance Systems and concluded that a networked surveillance system either exists or is in development. The group can further improve upon the current technology by creating an autonomous tracking system. From the readings of the current technology, the surveillance is still conducted by a user through a third party. The networked system is applied to UAV predator systems, and Land Warrior/Future Warrior agenda for the military. Tracking is done by the user and not the computer itself.

If a system can be created to alert a user and help track tagged targets, it may be a viable idea. A crossbreed of a radar tracking system with a surveillance camera system would be the next logical step. [1]-[6]

Another member of the team looked into Technologies in Military Binoculars to find if our ideas and research were original and if they were congruent with the military needs and interests. It was concluded that the military is paying two companies to research technologies that would allow binoculars to read and utilize brainwaves to mimic human

intelligence capabilities and identify critical components in image processing. They are also paying DARPA to research and develop capabilities for binoculars to utilize light refraction and lens-like qualities of “heat haze” to produce more clear images at further distances and readings. Rumors circulate of the military requesting binoculars that utilize laser communication technology to send information from one set of binoculars to another. This would allow images viewed by one set of binoculars to be viewed by an operator utilizing another set of binoculars, in a different location. These findings show a military interest in binocular technologies. The last finding seems to show a similar concept to ours but the source does not look too reliable. Confirmed evidence that the government has a contract for this kind of technology was not found but it seems the interest exists. [7]-[9]

The two previous applications involved video tracking and therefore there were several members doing research in video surveillance. One of them wanted to know if massive camera surveillance is effective. He found that, according to recent articles, CCTV implementations are not effective. It is said that it takes 1000 cameras to solve one crime. In a month, CCTV has captured 8 out of 269 suspected robbers. One of the purposes for these cameras is to film crimes. These footages can be used in court but most film that is taken is of such poor quality that it cannot be used in court as evidence. The presence of the cameras does not deter criminals from committing crimes right in front of them. Mike Milks, chief executive of Scyron, which helps police analyze CCTV images, said “We estimate that about half of the CCTV cameras in the country are next to worthless when it comes to safeguarding the public against crime and assisting the police to secure convictions”. As many as half of the images collected by CCTV cannot be used in court. Also, a report found that untrained officers were often using CCTV images in their hunt for evidence. Cameras were effective if the images were used properly. There is a proposed solution to use “new computer software that enables camera to only record specific incidents”. Home Office of the UK says that CCTVs are useful because they “help communities feel safer.” [10]-[13]

Another member approached the subject of video tracking from the point of view of Gait Analysis, finding the available technologies and evaluating the possibility of adapting them to the Smart Binoculars. Gait analysis is the study of animal locomotion. In humans this is done to maximize athletic performance, identify posture problems and to help in rehabilitation. Among the different techniques of Gait Analysis video recording and analyzing is an interesting way to measure joint angles and velocities in two or three dimensions. Passive markers are tracked with infrared radiation. Depending on how it is reflected, the position of the marker can be inferred. It is possible to track or recognize objects in a video using basically two approaches: zone and blob. The first one maps the image into zones and analyzes how they change from frame to frame. The second approach identifies pixels with certain parameters (brightness, color) and tracks them form frame to frame. There is commercial software available that does this task. It is important to have consistent lighting in the scene to avoid color and brightness variations, in order to track the object correctly. The shape of the object and the position of the camera have to be such that the software recognizes the object in every frame to prevent

losing its track. There is a Japanese group that created a surveillance device that minimizes the amount of cameras by automating tracking of suspicious persons. [14]-[17]

Additional research was done in the field of video tracking to find software capable of doing video tracking for the purposes of automation of the SmartBinoculars. Possible software that can be used for this purpose is the SwisTrack developed in the EPFL in Lausanne, Switzerland. This software can be used to track people, robots and animals. It is open source and uses Intel's OpenCV library for the video processing and processing can be done in real time and to .avi videos as well. The processing is done using the built in components. New components can be programmed and included to the processing configuration, for specialized tasks. Position and trajectory information can be transmitted via TCP/IP in NMEA 0183 format. [18] [19]

After the second research week, the team decided to stop looking into video analysis and decided to work with a hands-free device that could provide information about the user's location relative to other known parameters.

In order to do this, we needed information about Head Up Displays (HUD). Aircraft use what is called a Head up Display. That is a piece of material that light is reflected off of. The Head up Display is mounted onto aircraft cockpits in front of the pilot's straight ahead line of sight.



Figure 1. The HUD gives the pilot important flight data while in stable level flight. Some of the data in this particular picture include time, directional heading, aircraft roll, aircraft pitch, aircraft velocity, aircraft angle of attack, altitude. When this aircraft engages a target, more indicators would probably show up on the screen indicating weapon and target information. [20]

As the search for some sort of data display unit continued, the virtual reality gaming industry was discovered and noted. The websites that talked about virtual reality headsets had some interesting thoughts in terms of product Do's and Don'ts the team should keep in mind on a project like this. The websites reviewed displayed several attempts at head

mounted virtual reality units, yet both the websites seemed to state the virtual reality systems have fairly poor graphic resolution and also have relatively low unit sales.

The negative connotation received towards the virtual reality gaming industry persuading more researching in a head mounted data display area. Information was discovered on the F-35 Joint Strike Fighter's Head Mounted Display (HMD). That displays mostly the same information as the Head Up Display shown above, only the F-35's HMD is mounted on the pilots helmet. This gives them the ability to look anywhere (in comparison to solely directly ahead with the HUD) and still be able to see flight and target information. There are very few aircraft that have a HMD. Most aircraft currently have a HUD.

A HMD could be built to provide the user with data that is important to them. Some of the applications could be directional waypoints, object locations, friend locations, object-self distance, geographic information, velocity, heading, and date/time. [20]-[23]

3. The final product

3.1. Brief description of the product

Current technology exists for communication, tracking, and GPS purposes. The technology involved includes hand-held GPS units, compasses, range-finders, maps, and radios.

On the paintball field there is no technology that helps a paintball player differentiate between friend and foe. Current technology does not provide an efficient platform for object visual identification, navigation, or team communication. Current positional technology requires the user to operate several separate hand held devices to determine the user's spatial coordinates, direction, and distance from a point of interest. To communicate these details to others requires the user to translate the directional and spatial information through a communication device such as a phone or radio. The steps involved to determine and communicate location are currently a very time consuming process. This lapse in communication and the current limitations of handheld technologies often make it difficult for troops and paintball players to distinguish between their teammates and enemies. This confusion results in friendly fire.

Smart Specs is a revolutionary design that integrates GPS information in a HMD. The device is worn as glasses or goggles, and has real-time information displayed in the user's normal field of vision. The display shows markers where a specific coordinate would be, relative to the user's position and current field of view. As the user moves the head, the point moves to designate where that point of interest is, in relation to the user. The point lights up on the goggles as a small indicator, but does not obstruct the user's vision of the surroundings. The purpose is to augment the user's normal field of view with important information. Not only does this information include a tag of specific interest points, but it also displays the heading and range of the location, in relation to the

user's position. This information is also shared among the devices of multiple users, which allows them to see the points of interest, relative to their individual position.

To reduce the chances of friendly fire, Smart Specs aids in visual object identification and team communication. Smart Specs displays positional information in the user's regular field of view, allowing the user to keep focus on their surroundings and environment. Smart Specs provides positional information to all team members for simultaneous team position awareness. This information gives the user real-time identification of teammates through a HMD. On the battlefield, distinguishing between teammates and enemies will reduce the chances of friendly fire and optimize team coordination.

3.2. Design requirements

Many who play paintball competitively enough to be interested in our product will already have an expensive or favorite mask. This being the case, our product should be designed to fit on or around the consumer's mask and equipment to enhance their optical information gathering. Another approach is to manufacture the masks for the users that do not have one. The Smart Specs would be incorporated to the mask, and the user would be able to buy additional protective lenses and replace them as they wear. Figure 2 shows a graphical representation of the product.

A final kit would include shielded wires leading from the main unit to the player's mask, where it will be secured into the existing headband and structured to allow the wires to separate and pass along the player's head to both ends of the clear protective lens. A final product kit would potentially include a power switch, a dimmer switch, a lens focus button, and a synchronizing button. The team was informed by a paintball player, well in tune with the community, that there is an unspoken standard within the paintball industry. That standard says paintball equipment uses nine volt batteries.

If a user does not want to purchase the full visual unit, an economical alternative is to sell trackers that some team members can carry in order to be identified by a member wearing the Smart Specs. Current ideas on how to go about this would be an integration of some sort of positional information, like GPS, a wireless transmitter, and a microcontroller. That would reduce costs for the consumer because there would be no need for a visual unit, or a compass, while still being identified by others with the full HMD unit.

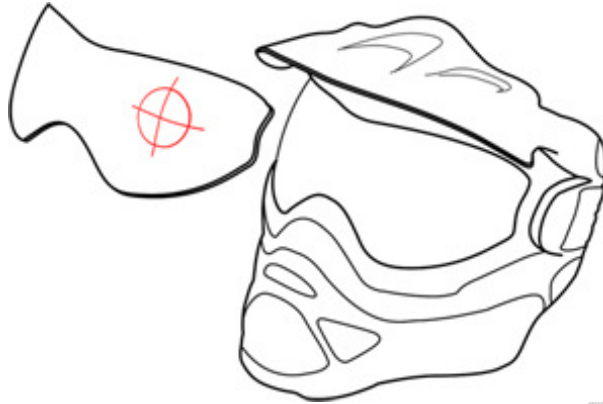

Figure 2. Graphical representation of the Smart Specs for the Paintball industry.

3. The prototype

3.1. Objective of the prototype

The prototype for the end of the Fall semester of 2009 is expected to demonstrate basic GPS, compass and wireless communication management in a rather simple physical setup. This will be done between two persons, one of them in a computer giving directions and the other in the field being directed. The person in the computer will select a point in a map and the device, located a distance away, will guide the other person to head in the direction of the designated point. This proves the fact that we can wirelessly communicate information about the location of some point to a device that, depending on its position, will do the calculations and will guide the user to the point.

The principal part of the prototype is a pair of glasses, simulating the HUD, with a LED in each side and a device to hold the compass. The specs are connected to the main unit which has the GPS, the wireless module, the microcontroller and the battery. The second part of the prototype is a similar unit with GPS, wireless module and microcontroller connected to a computer. The computer is the interface for the user to select a point in a map, which he or she wants the other user to look at. The position of the point is sent to the principal device and it calculates where the point is, relative to its position. The LEDs in the HUD will blink, telling the user in what direction the point is at. The device keeps directing the user to the point until another point is selected in the map, or the devices are turned off.

The technical team was divided in three subteams: hardware, software and design. The hardware team had to look for the correct components that would perform the task. They had to be sure that the components were compatible with each other and that the technical specifications were appropriate for the objective of the prototype. The software team had to write the code that would make the components to communicate with each other and do the task. Finally, the design group designed and constructed the glasses with the LEDs and the main unit.

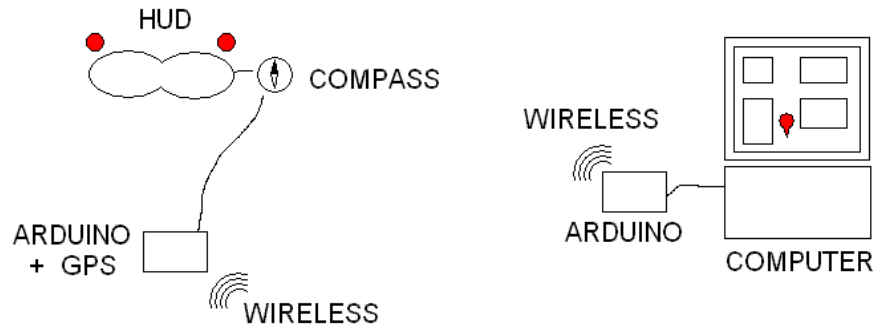

Figure 3. Graphical representation of the prototype. The computer sends information of a location to the unit. The unit receives the information, uses its position and heading to calculate where the point is and directs the user to the point.

3.2. Hardware

3.2.1. Arduino

Arduino is a physical computing platform based on a simple open hardware design for a single-board microcontroller, with embedded I/O support and a standard programming language. The Arduino programming language is based on Wiring and is essentially C/C++. Arduino is a microcontroller module with USB connection. It is intended for artists, designers and hobbyists.

Arduino can be used to develop stand-alone interactive objects or can be connected to software on your computer like Flash, Processing, MaxMSP. Arduino board is easy to use in almost any electronic or robotics project. The Arduino Duemilanove is essentially a robot "brain" able to send and receive signals and then take action based on calculations and logic. [24]

Features:

- 13 digital pins
- 6 analog pins
- Regulated 5V and 3.3V output pins
- Three power options: USB, Wall adapter or Vin/GND pin
- Tx/Rx serial communication pins
- Mini LED connected to pin 13 and status LEDs

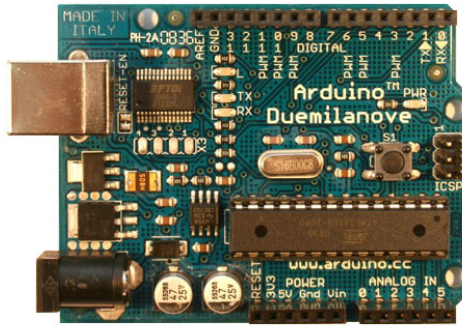

Figure 4. Arduino Duemilanove. [24]

3.2.2. Compass

Compass module with tilt compensation.

Compass Module with Tilt Compensation is the latest IC module in compass arena. These modules have 3-axis magnetic sensor and 3-axis accelerometer, analog and digital support circuits and integrated with programmable in PIC core running all the calculation. By combining all those packages the direction of the compass will remain the same even when the board is tilted. This compass is used in devices such as binoculars, cameras, night vision optics, laser ranger finders, antenna positioning, and other industrial compassing applications.

Features	Benefits
Compass with heading/tilt outputs	A complete compass solution including compass firmware
3-axis MR sensors, accelerometers and a microprocessor in a single package	A digital compass solution with heading and tilt angle outputs in a chip-scale package
Compass algorithms	For computation of heading, and magnetic calibration for hard-iron
9 x 9 x 1.9mm LCC Surface Mount Package	Small size, easy to assemble and compatible with high speed
Low voltage operations	Compatible with battery powered applications
EEPROM memory	To store compass data for processor routines
Digital Serial Data Interface	I2C Interface, easy to use 2-wire communication for heading output

Moderate Precision Outputs	Typical 2° Heading Accuracy with 1° Pitch and Roll Accuracy
Lead Free Package Construction	Complies with RoHS environmental standards
Flexible Mounting	Can be mounted on horizontal or vertical circuit boards

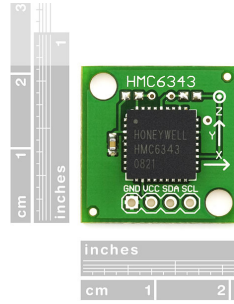

Figure 5. Compass module. [24]

3.2.3. Wireless

The XBee 1mW Chip Antenna is the wireless unit used for the prototype. Wireless communication is the transfer of information over a distance without the use of wires. The distances involved may be short a few meters as in remote control or long, thousands or millions of kilometers for radio communications. When the context is clear, the term is often shortened to "wireless". This module of wireless supports simple communication point and multi-point networks. This series is 2.40 GHz communication modules take the 802.15.4 stack and lays a very useful serial command set on top of it, making it very popular, very reliable and simple for communication between microcontrollers, computer, and systems.

XBee 802.15.4 features:

- 1 mW chip antenna (great for tight spaces)
- 1 mW output (but the chip antenna designation kind of gives that away already)
- 250kbps communication speed
- 3.3V @ 50mA power consumption
- 90 meter (300 ft) range (in ideal circumstances, but really, these do have good range)
- 6 10-bit ADC input pins
- 8 digital I/O pins
- 128-bit encryption
- Industrial temperature rating (-40° C to 85° C), so feel free to use it in your hot-tub in Iceland.
- FCC certified for USA, Canada, Australia, & Europe.

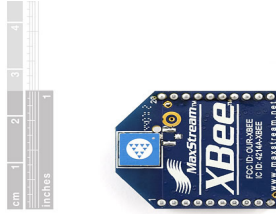

Figure 6. XBee wireless unit. [24]

3.2.4. GPS

Global Positioning System (GPS) receiver is a device that can tell you exactly where you are on Earth at any moment with clear view of the sky by using three-dimensional location (latitude, longitude, and altitude), provided by GPS satellites from space. GPS is a group of 27 satellites but only 24 in operation and other three as backup in case one fails. Each of these 3,000 to 4,000-pound solar-powered satellites circles the globe at about 12,000 miles (19,300 km), making two complete rotations every day. The orbits are arranged so that at anytime, anywhere on Earth, there are at least four satellites "visible" in the sky.

Features (EM-406A)

Chipset	SiRF Star III
Frequency	L1, 1575.42 MHz
C/A code	1.023 MHz chip rate
Channels	20 channel all-in-view tracking
Sensitivity	-159 dBm
Main power input	4.5V ~ 6.5V DC input
Power consumption	44mA
Operating temperature	-40C to +85C

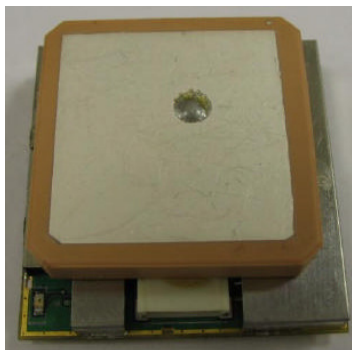

Figure 7. GPS module. [25]

3.3. Software abstract

GPS uses a xyz coordinate plane with origin centered at the center of the earth to describe objects on or around the Earth. Because of this simplicity, we can use three dimensional vectors to identify the location of an object relative to another object. In this instance of the problem, we are calculating the rotation angle between an object and an observer. Since our compass gives an angle relative to north we need to calculate the angle between the object and north.

A plane can be used to represent both the object and north here because our simplified concept has no notion of pitch and will only direct movement in a single plane tangent to the surface of the earth at the location of the observer. We will call this plane the “tangent plane”.

The first step is to calculate a plane to which we want to align our line of vision. We will call this plane the “object plane” (light gray in Figure 8). A plane is defined by two vectors. In this case, the two vectors will be a vector from the center of the earth to the object and a vector from the center of the earth to our current location. Using a vector cross product we can find a vector normal to the object plane.

Next we find the plane between our current location and the North Pole. We will call this plane the “north plane” (dark grey in Figure 8). From GPS we have the vector from the center of the earth to our current location. For the north pole we use the vector $\langle 0,0,1 \rangle$. Using a vector cross product we can find a vector normal to the north plane.

We now have 2 normal vectors representing our planes, an object normal and a north normal. The angle between the two vectors will be the same angle as the angle between the planes. We can find the angle between the vectors using this formula:

$$\cos \alpha = \frac{\mathbf{u} \cdot \mathbf{v}}{\|\mathbf{u}\| \|\mathbf{v}\|}$$

Then we subtract our heading from that angle to get the angle we have to rotate.

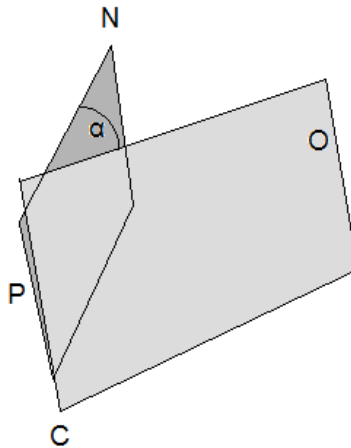

Figure 8. The object plane, in light gray, is defined by the position of the person (P), the object (O) and the center of the Earth (C). The north plane, in dark grey, is defined by the position of the person, the North Pole (N) and the center of the Earth. The angle α that the person has to rotate in order to look at the object is the same angle between the vectors normal to the planes.

The code used in the prototype is attached in Appendix 6.

3.4. Stage of the prototype

The prototype was able to direct the user wearing the glasses to a point selected by another user in a map.

3.5. Future modifications to the prototype

Accuracy

The accuracy in position of the device is greatly affected by the quality of the GPS. A more accurate GPS is suggested for the following prototypes. Another option is to look into Local Positioning Systems that give more accurate results.

Display

It is recommended that the visual system be re-investigated. OLED was researched. We found that most of the visual systems currently in existence are projection based. That might be a reasonable method to go. The visual system's design requirements may change depending on what the technology integrated with the system is. OLED technology is still largely in development although it has large promises for the future. If either of these options is not viable, a LED array could also be designed as well. [26]-[28]

Micro-vision is a company currently developing a projection technology that will go into wearable displays. We are looking at them as our potential partners if we wish to integrate their technology into our masks.

Miniaturization of electronics

Whatever the final design comes out to be, miniaturization will have to be done. Miniaturization may influence design requirements, because it will give a good idea of the size of the final product, before the final design can be conceptualized. It might be a good idea to figure out exactly what components will accomplish the design requirements, and then miniaturize the components to continue finalizing the design.

4. Future developments of the product

This is a list of possible technologies that could help to develop the product in the different applications that the team considers viable.

4.1. DGPS

Differential GPS (DGPS) is a technique used to improve positioning or navigation accuracy. The basic idea is to gauge GPS inaccuracy at a stationary receiver station with a known location. Since the DGPS hardware at the station already knows its own position, it can easily calculate its receiver's inaccuracy. The station then broadcasts a radio signal to all DGPS-equipped receivers in the area, providing signal correction information for that area. In general, access to this correction information makes DGPS receivers much more accurate than ordinary receivers.

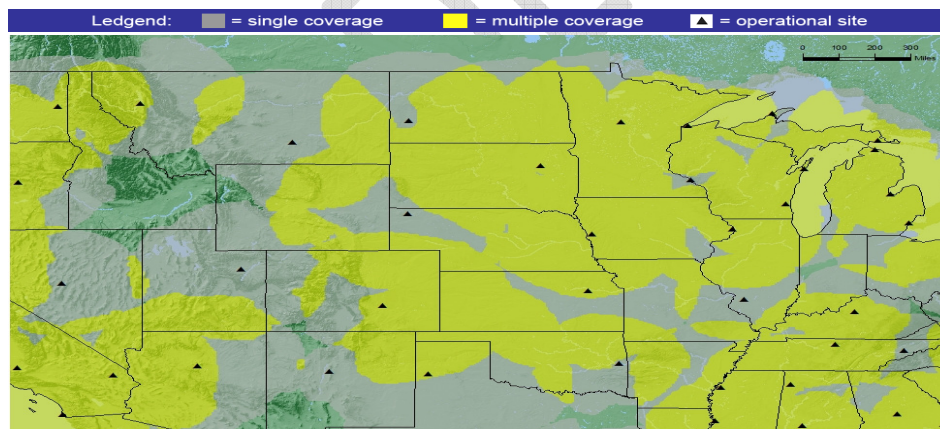

Figure 9. Coverage of different positioning technologies. [29]

4.2. Wide Area Augmentation System (WAAS)

A system of satellites and ground stations that provide GPS signal corrections for better position accuracy. A WAAS capable receiver can give you a position accuracy of better than three meters. WAAS consists of approximately 25 ground reference stations positioned across the United States that monitor GPS satellite data. Two master stations, located on either coast, collect data from the reference stations and create a GPS correction.

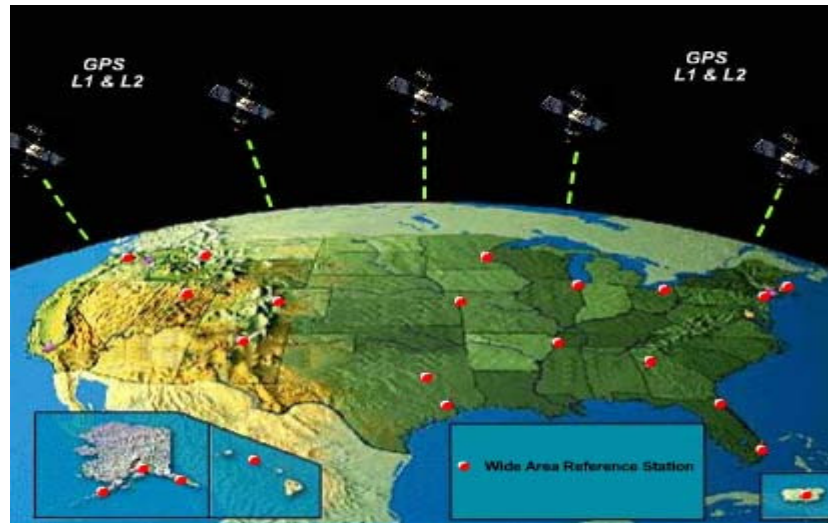

Figure 10. Schematic of the WAAS and GPS systems. [30]

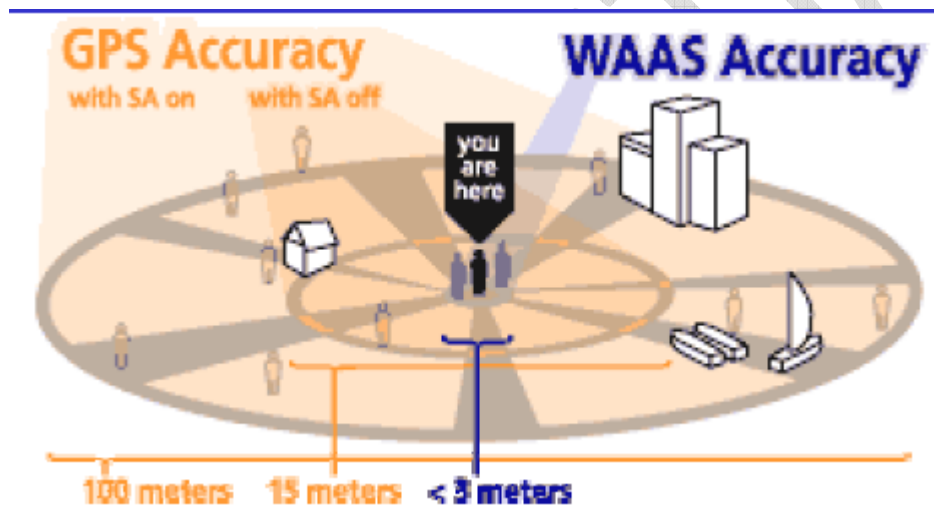

Figure 11. Comparison of accuracy of the different positioning technologies. [31]

Accuracy of different positioning systems:

- Original GPS: 100 m
- GPS without SA: 15 m
- DGPS: 3-5 m
- WAAS: < 3 m

References

- [1] http://en.wikipedia.org/wiki/MQ-1_Predator (D. Hopkins)
- [2] http://en.wikipedia.org/wiki/MQ-9_Reaper (D. Hopkins)
- [3] http://en.wikipedia.org/wiki/Future_Force_Warrior (D. Hopkins)
- [4] http://en.wikipedia.org/wiki/Future_Combat_Systems (D. Hopkins)

- [5] Predator RQ-1/ MQ-1/ MQ-9 Unmanned Aerial Vehicle, USA. <http://www.army-technology.com/projects/predator/> (D. Hopkins)
- [6] Land Warrior Integrated Modular Fighting System, USA http://www.army-technology.com/projects/land_warrior/ (D. Hopkins)
- [7] Military Developing Brainwave Binoculars. http://www.msnbc.msn.com/id/25374031/ns/technology_and_science-innovation/ (N. Spitler)
- [8] Shimmer Vision Military Binoculars. http://www.msnbc.msn.com/id/25374031/ns/technology_and_science-innovation/ (N. Spitler)
- [9] Datalink Binoculars. <http://www.fas.org/irp/agency/inscom/journal/97-jan-feb/janfebpage40.htm> (N. Spitler)
- [10] Wikipedia, "Closed circuit television". http://en.wikipedia.org/wiki/Closedcircuit_television (J. Kobayashi)
- [11] Telegraph, " 'Worthless' CCTV camera footage is not good enough to fight crime, leading QC warns". Christopher Hope. <http://www.telegraph.co.uk/news/newsttopics/politics/6088086/Worthless-CCTV-camera-footage-is-not-good-enough-to-fight-crime-leading-QC-warns.html> (J. Kobayashi)
- [12] IEEE Spectrum, "London's Million CCTV Cameras Highly Ineffective in Solving Crimes". Robert Charette. <http://www.spectrum.ieee.org/blog/computing/it/riskfactor/londons-million-cctv-cameras-highly-ineffective-in-solving-crimes> (J. Kobayashi)
- [13] BBC News, "1,000 cameras 'solve one crime'". http://news.bbc.co.uk/2/hi/uk_news/england/london/8219022.stm
- Telegraph, "1,000 CCTV cameras to solve just one crime, Met Police admits". Christopher Hope. <http://www.telegraph.co.uk/news/uknews/crime/6082530/1000-CCTV-cameras-to-solve-just-one-crime-Met-Police-admits.html> (J. Kobayashi)
- [14] Gait Analysis. http://en.wikipedia.org/wiki/Gait_analysis (C. Roa)
- [15] Video Tracking. http://en.wikipedia.org/wiki/Video_tracking (C. Roa)
- [16] Few Principles on Video Tracking. <http://www.tigoe.net/pcomp/videoTrack.shtml> (C. Roa)
- [17] A Surveillance Video System Based on Omni-directional and Network Controlled Cameras (.pdf available). (C. Roa)
- [18] <http://www5.epfl.ch/swis/page3080.html>. (C. Roa)
- [19] <http://en.wikibooks.org/wiki/SwisTrack>. (C. Roa)
- [20] http://en.wikipedia.org/wiki/Head_up_display (E. Fairall)
- [21] http://en.wikipedia.org/wiki/Head-mounted_display (E. Fairall)
- [22] <http://www.stereo3d.com/hmd.htm#links> (E. Fairall)
- [23] http://www.vsi-hmcs.com/pages_hmcs/03a_f35day.html (E. Fairall)
- [24] Arduino Website. <http://www.arduino.cc/> (M. Pain)
- [25] Robot Shop Website. <http://www.robotshop.us/Images/big/en/usglobalsat-em-406-gps-module.jpg> (M. Pain)
- [26] <http://www.5min.com/Video/Samsung-Transparent-OLED-Display-92539988> (M. Pain)
- [27] http://video.google.com/videoplay?docid=-5392488100974063103&ei=HtzySvWgGafEqgKW_vjhDA&q=OLED&hl=en# (M. Pain)

- [28] <http://www.oled-display.net/how-works-the-oled-technology> (M. Pain)
[29] <http://www.navcen.uscg.gov/images/plots/c-1.jpg> (M. Pain)
[30] http://www.faa.gov/about/office_org/headquarters_offices/ato/service_units/techops/navservices/gnss/waas/howitworks (M. Pain)
[31] <http://www.garmin.com/aboutGPS/waas.html> (M. Pain)

CONFIDENTIAL

THIS PAGE INTENTIONALLY LEFT BLANK

CONFIDENTIAL

Appendix 5: Survey Response

Interviewee: Paul Marks
Contact info: pmarks@iit.edu

Interviewer: Noah Spitler
Contact info: cornchip44@gmail.com
Date: 11/18/09

1. What type of paintball do you play?
(a) Recreational (b) tournament (c) scenario
A and C
2. How often do you play paintball?
In the summer perhaps twice a month at most, rest of the year no more than 4 times depending on the weather.
3. On average, how much money do you spend on paintball a month?
<\$50
4. What is the estimated value of all your paintball equipment?
~\$200
5. Do you normally go paintballing with a group or by yourself?
A group
6. Do you play paintball indoors or outdoors?
Outdoors, but I've only had the opportunity to play outdoors.
7. Have you ever convinced your friend(s) to purchase a particular paintball product you own?
I convinced a friend to buy the same model of marker after he used mine
8. Have your friends ever convinced you to purchase a particular paintball product they own?
Yes – a particular hopper and facemask
9. Have you ever used GPS while playing paintball? Can you foresee any usefulness in having a GPS unit on the battlefield?
No I have not – Yes probably could be very useful in an intense scenario paintball tournament (something to the effect of D-Day)
10. During a paintball game, are you concerned about distinguishing between friend and foe? (i.e. Do you ever worry about accidentally shooting a teammate?)
Yes, though we are typically marked (usually colored tape on the arm) friendly fire is a concern and issue sometimes.
11. Neglecting cost, would you have any interest in purchasing a product that aided you in distinguishing between friend and foe in the midst of battle?
If the game was large enough and something like a scenario game then yes I believe that would be a valuable asset to a team.

Interviewee: Mike Hartwig
Contact info: mhartwig@iit.edu

Interviewer: Noah Spitler
Contact info: cornchip44@gmail.com
Date: November 19, 2009

1. What type of paintball do you play?
(a) Recreational (b) tournament (c) scenario
All of the above.
2. How often do you play paintball?
1 to 2 times a month.
3. On average, how much money do you spend on paintball a month?
~\$75
4. What is the estimated value of all your paintball equipment?
A little over \$1500 I'm guessing.
5. Do you normally go paintballing with a group or by yourself?
Normally a group.
6. Do you play paintball indoors or outdoors?
Mostly outdoors, maybe indoors once or twice during winter.
7. Have you ever convinced your friend(s) to purchase a particular paintball product you own?
Yes.
8. Have your friends ever convinced you to purchase a particular paintball product they own?
Yes.
9. Have you ever used GPS while playing paintball? Can you foresee any usefulness in having a GPS unit on the battlefield?
Never used it while playing, but it could be very helpful in scenario ball. Not so much in reball or tournaments.
10. During a paintball game, are you concerned about distinguishing between friend and foe? (i.e. Do you ever worry about accidentally shooting a teammate?)
Yes. That happens quite a bit.
11. Neglecting cost, would you have any interest in purchasing a product that aided you in distinguishing between friend and foe in the midst of battle?
Yes, that would be sweet for a scenario game. GPS with the locations of your teammates would be cool. Why am I not in this IPRO?

Interviewee: Bill Krasner

Contact info:

Interviewer: John McCluskey

Contact info:

Date: Nov 14, 2009

1. What type of paintball do you play?
(b) tournament
2. How often do you play paintball?
Every weekend, practices and tournaments
3. On average, how much money do you spend on paintball a month?
Up to \$500
4. What is the estimated value of all your paintball equipment? **\$2000 - guns bottles masks loaders, but I have spend more than that ever, its been quite a few years I've been playing.**
5. Do you normally go paintballing with a group or by yourself? **With friends, usually 5 on 5, but lots of people there**
6. Do you play paintball indoors or outdoors? **Outdoors always**
7. Have you ever convinced your friend(s) to purchase a particular paintball product you own? **Yeah, I want my team to win and its frustrating to see teammates let you down because of a equipment malfunction that you don't have because you have a better one.**
8. Have your friends ever convinced you to purchase a particular paintball product they own? **Yes, I keep my eyes open for new stuff my friends have or even people that are beating us, I keep an open mind.**
9. Have you ever used GPS while playing paintball? Can you foresee any usefulness in having a GPS unit on the battlefield? **No, I don't, I think too much technology information can distract far too much.**
10. During a paintball game, are you concerned about distinguishing between friend and foe? (i.e. Do you ever worry about accidentally shooting a teammate?)
Yeah, but such is the game. I don't usually do it, quick thinking, or get the jump on them.
11. Neglecting cost, would you have any interest in purchasing a product that aided you in distinguishing between friend and foe in the midst of battle? **Yeah but I dunno if I'd continue to use it, but I'd be willing to try.**

Interviewee: Nick Hauser
Contact info:

Interviewer: John McCluskey
Contact info:
Date: Nov 14, 2009

1. What type of paintball do you play?
(b) tournament
2. How often do you play paintball? **Every weekend, practices and tournaments**
3. On average, how much money do you spend on paintball a month? **Up to \$500**
4. What is the estimated value of all your paintball equipment? **Well what I paid was about \$1500 for like 2 guns bottles masks loaders,**
5. Do you normally go paintballing with a group or by yourself? **With my team of about 8 of us on a 5 man game**
6. Do you play paintball indoors or outdoors? **Outdoors, indoor places sucked**
7. Have you ever convinced your friend(s) to purchase a particular paintball product you own? **Yes, that is usually how most people get their stuff, whatever is hyped, hype is a huge seller of stuff. I hear stuff from forums, magazines, stuff at paintball stores, friends especially.**
8. Have your friends ever convinced you to purchase a particular paintball product they own? **Yes, guns, masks, there are tons of products out there, and seeing what other people are trying out and being successful is key, and there is no better way to get the best stuff than first hand reviews**
9. Have you ever used GPS while playing paintball? Can you foresee any usefulness in having a GPS unit on the battlefield? **No, I don't know anyone that has, I assume you would only use it if you were in the D-Day scenario one, that has thousands of people in it and on a large playing field.**
10. During a paintball game, are you concerned about distinguishing between friend and foe? (i.e. Do you ever worry about accidentally shooting a teammate?) **Well in speedball, people are mostly wearing team jerseys and are all the same color so its not that hard to tell, but I assume in the woods in woodland cammo it would be a huge problem especially with a non centralized uniform attire.**
11. Neglecting cost, would you have any interest in purchasing a product that aided you in distinguishing between friend and foe in the midst of battle? **Yeah that would be sweet, it would make life so much easier, but it would have to be really seamless and streamlined if to be more useful than a fuss in speedball.**

THIS PAGE INTENTIONALLY LEFT BLANK

CONFIDENTIAL

Appendix 6: Prototype Code

1. Headset Application

```

#include <Wire.h>
// #include <Compass.h>
#include <NewSoftSerial.h>
#include <SoftwareSerial.h>

#define rxPin 2
#define txPin 3

#define rightLedPin 12
#define leftLedPin 11
SoftwareSerial mySerial = SoftwareSerial(rxPin, txPin);
// Compass compass(0x32); // 0x42 is the address of the compass with our current setup

struct ecef convert2Ecef(struct longLat);
struct normal getNormal( struct ecef, struct ecef);

const int ledPin = 13;
const float pi=3.14159265;
int compassSlaveAddress = 0x32 >> 1;

char inByte=' ';
int inCharNum=0;
char buf[100];

boolean newPeriod = true;
long period;
long beginMills;

int i;
float selfHeading, objectHeading, angleToTurn;
byte headingData[2];

char DEBUG_LOCAL_COORD[] = "41.836017,-87.628267,181,0";

struct longLat{
    double latitude;
    double longitude;
    int altitude;
};

```

```
struct ecef{
  float x;
  float y;
  float z;
};
```

```
struct normal{
  float i;
  float j;
  float k;
};
```

```
struct longLat objectLongLat;
struct ecef objectEcef;
```

```
struct longLat selfLongLat;
struct ecef selfEcef;
```

```
void setup() {
  pinMode(rxPin, INPUT);
  pinMode(txPin, OUTPUT);
  pinMode(rightLedPin, OUTPUT);
  pinMode(leftLedPin, OUTPUT);
  mySerial.begin(9600);
  Serial.begin(9600);
  //compass.setup();
  objectEcef.x=0;
  objectEcef.y=0;
  objectEcef.z=1;
  Wire.begin();
}
```

```
void loop(){
  if((inByte = mySerial.read()) != '%'){
    //Serial.println(inByte);
    if(inByte=='$'){
      while(inByte != '!' && inCharNum<30){

        delay(9);
        inByte =mySerial.read();
        buf[inCharNum++] = inByte;
      }
    }
  }
}
```

```

    }
    //Serial.print("buf: ");
    // Serial.println(buf);
    objectLongLat = parseIncomingString(buf);
    objectEcef = convert2Ecef(objectLongLat);
    //Serial.println(objectEcef.x);
    //Serial.println(objectEcef.y);
    //Serial.println(objectEcef.z);
    inCharNum=0;
    inByte=' ';
    }
}
//Serial.print(inByte);
//read coords from gps
    digitalWrite(ledPin, HIGH);
char coords[50];
strcpy(coords, DEBUG_LOCAL_COORD);
selfLongLat = parseIncomingString(coords);
selfEcef = convert2Ecef(selfLongLat);
struct ecef np;
np.x=0;
np.y=0;
np.z=1;

struct normal sO = getNormal(selfEcef, objectEcef);
struct normal sNP = getNormal(selfEcef, np);

float cosTheta = (sO.i*sNP.i + sO.j*sNP.j + sO.k*sNP.k) / (sqrt(pow(sO.i,2) +
pow(sO.j,2)+ pow(sO.k,2) )*sqrt(pow(sNP.i,2) + pow(sNP.j,2)+ pow(sNP.k,2)));
objectHeading = acos(cosTheta)/pi*180;

Wire.beginTransaction(compassSlaveAddress);
Wire.send(0x50); // The "Get Data" command
Wire.endTransmission();
delay(10); // The HMC6352 needs at least a 70us (microsecond) delay
Wire.requestFrom(compassSlaveAddress, 2); // Request the 2 byte heading (MSB
comes first)
i = 0;
while(Wire.available() && i < 2)
    headingData[i++] = Wire.receive();
selfHeading = (headingData[0]*256 + headingData[1])/10; // Put the MSB and LSB
together

if(selfLongLat.longitude>objectLongLat.longitude)
    objectHeading=(180-objectHeading)+180;

```

```
angleToTurn = objectHeading-selfHeading;
if(angleToTurn>180)
  angleToTurn = -1*(360-angleToTurn);
if(angleToTurn<-180)
  angleToTurn = (360+angleToTurn);
```

```
Serial.println(angleToTurn); // The whole number part of the heading
```

```
if(angleToTurn>5){
  flash(rightLedPin,angleToTurn);
  digitalWrite(leftLedPin, LOW);
}
if(angleToTurn<-5){
  flash(leftLedPin,angleToTurn);
  digitalWrite(rightLedPin, LOW);
}
```

```
delay(20);
```

```
/*
Serial.println(objectEcef.x*1000);
Serial.println(objectEcef.y*1000);
Serial.println(objectEcef.z*1000);
```

```
lcd.clear();
lcd.print("longitude:");
lcd.print(objectLongLat.longitude);
delay(5000);
lcd.clear();
lcd.print("latitude:");
lcd.print(objectLongLat.latitude);
delay(5000);
lcd.clear();
lcd.print("altitude:");
lcd.print(objectLongLat.altitude);
delay(5000);
*/
}
```

```

void flash(int pin, long duration){
  if(abs(duration)<=30)
    period = 1000;
  else
    period = abs((long)1000/(duration/(long)30 ));

  if(newPeriod){
    beginMills = millis();
    newPeriod=false;
  }

  if((millis()-beginMills)<period/(long)2)
    digitalWrite(pin, HIGH);
  else if((millis()-beginMills)<period && (millis()-beginMills)>period/2)
    digitalWrite(pin, LOW);
  else if((millis()-beginMills)>period)
    newPeriod=true;
}

```

```

struct ecef convert2Ecef(struct longLat in){
  struct ecef out;
  float latitude = in.latitude/180*pi; //converting to radians
  float longitude = in.longitude/180*pi; //converting to radians
  float a = 6378137.0; // earth semimajor axis in meters
  float f = 1/298.257223563; // reciprocal flattening
  float e2 = 2*f - pow(f,2); // eccentricity squared

  float chi = sqrt(1-e2*pow(sin(latitude),2));
  out.x = (a/chi+in.altitude)*cos(latitude)*cos(longitude);
  out.y = (a/chi+in.altitude)*cos(latitude)*sin(longitude);
  out.z = (a*(1-e2)/chi+in.altitude)*sin(latitude);
  return out;
}

```

```

struct longLat parseIncomingString(char string[]){
    struct longLat out;
    out.longitude,out.latitude,out.altitude=0;
    char *posSave = 0;
    out.latitude = strtod(strtok_r(string,",&posSave),NULL);
    out.longitude = strtod(strtok_r(NULL,",&posSave),NULL);
    out.altitude = strtod(strtok_r(NULL,",&posSave),NULL);
    return out;

    /*char buf2[50];
    for (int l = 0; l<50; l++)
        buf2[l]=' ';
    int i=0;
    int j=0;
    int k=0;
    out.longitude,out.latitude,out.altitude=0;
    for(int i = 0; i <getSize(string);i++){
        delay(8);
        if(string[i] == ','){
            switch(k){
                case 0: out.latitude = strtod(buf2, NULL);
                case 1: out.longitude = strtod(buf2, NULL);
                case 2: out.altitude = strtod(buf2, NULL);
            }
            k++;
            j=0;
            char buf2[50];
            for (int l = 0; l<50; l++)
                buf2[l]=' ';
        }
        else{
            buf2[j++] = string[i];
            lcd.print(buf2);delay(1000);lcd.clear();
        }
    }
    //lcd.clear();lcd.print(out.longitude);
    return out;
    */
}

```

```
struct normal getNormal( struct ecef v1, struct ecef v2 ){
    struct normal out;
    out.i = (v1.y*v2.z)-(v2.y*v1.z);
    out.j = -((v1.x*v2.z)-(v2.x*v1.z));
    out.k = (v1.x*v2.y)-(v2.x*v1.y);
    return out;
}
```

```
//return the length of a string
int getSize(char string[]){
    int i=0;
    while(string[i]!='\0') i++;
    return ++i;
}
```

2. Desktop Application

```
#include <SoftwareSerial.h>

#define rxPin 2
#define txPin 3

SoftwareSerial mySerial = SoftwareSerial(rxPin, txPin);

char inByte=' ';
char buf[100];
int i=0;

void setup() {
    pinMode(rxPin, INPUT);
    pinMode(txPin, OUTPUT);
    mySerial.begin(9600);
    Serial.begin(9600);
}

void loop(){
    if (Serial.available() > 0) {
        buf[0]='$';
        i=1;
        while((inByte =Serial.read() ) != '!'){
```



```
        buf[i++] = inByte;
        delay(10);
    }
    buf[i] = '!';
    sendStuff(buf);
}
else{
    delay(40);
    mySerial.print("%");
}
}

void sendStuff(char string[]){
    //Serial.print(string);
    //Serial.print(getSize(string));
    for(int i=0;i<getSize(string);i++){
        //delay(500);
        delay(40);
        mySerial.print(string[i]);
    }
}

int getSize(char string[]){
    int i=0;
    while(string[i]!='\0') i++;
    return ++i;
}
```