

University of Chicago
Center for Civil Disobedience
by
Steven Pantazis
Advisor
Prof. Dr. Sean Keller

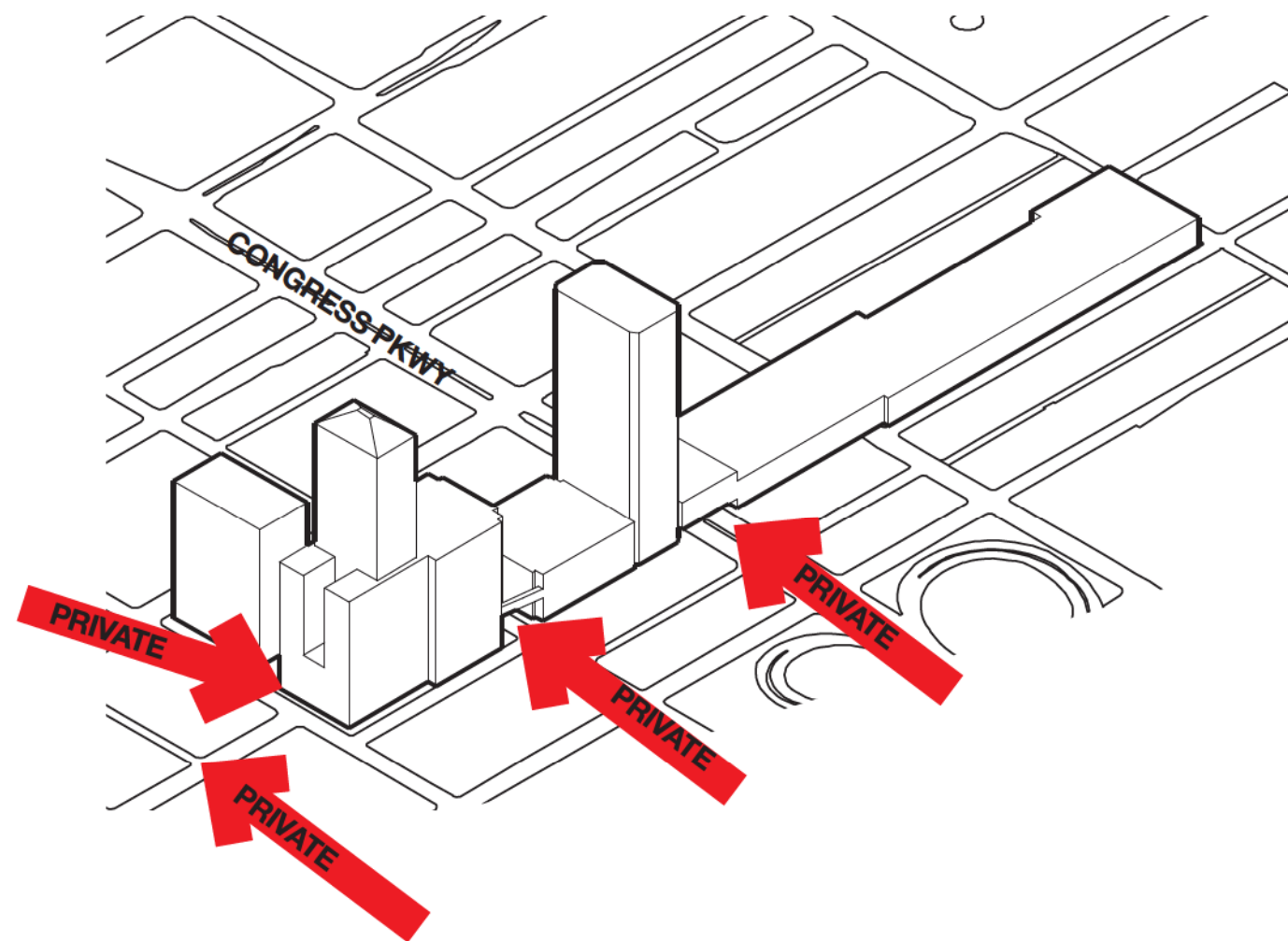



IMPETUS: THE PRIVATIZATION OF PUBLIC SPACE

Thesis Statement:
Can the concept of civil disobedience
[temporary, siteless] be formalized as
architecture [permanent]?

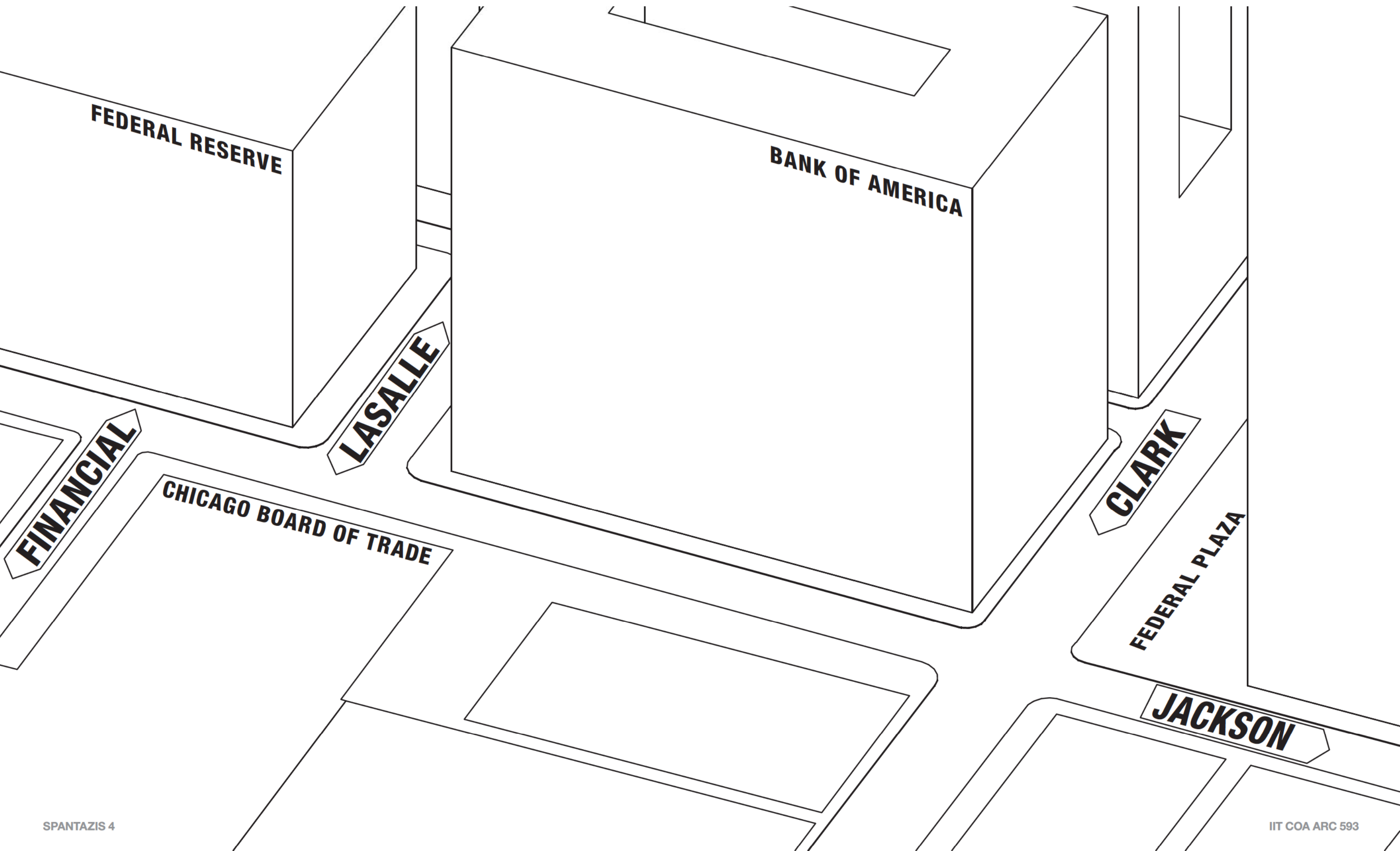

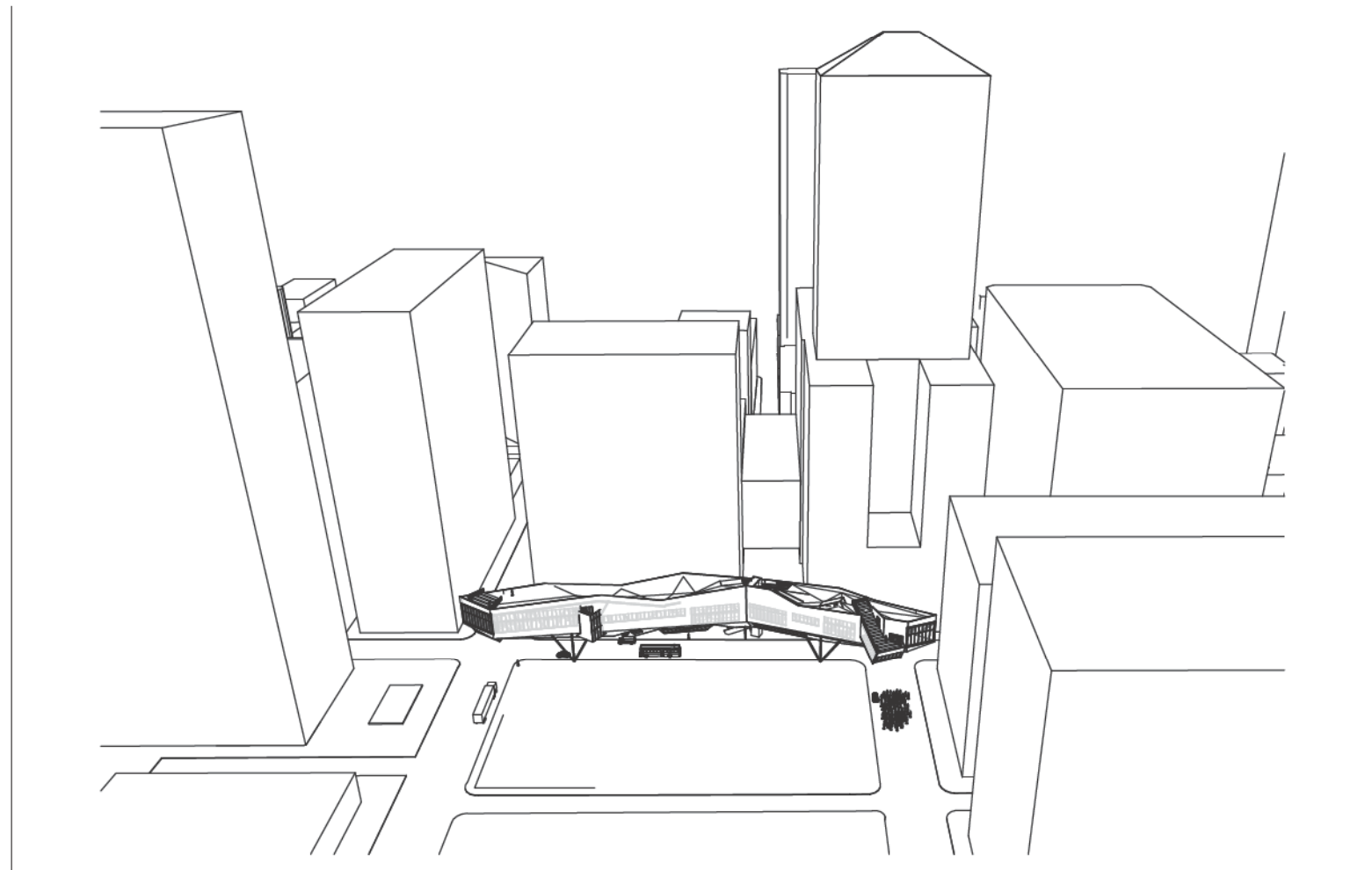
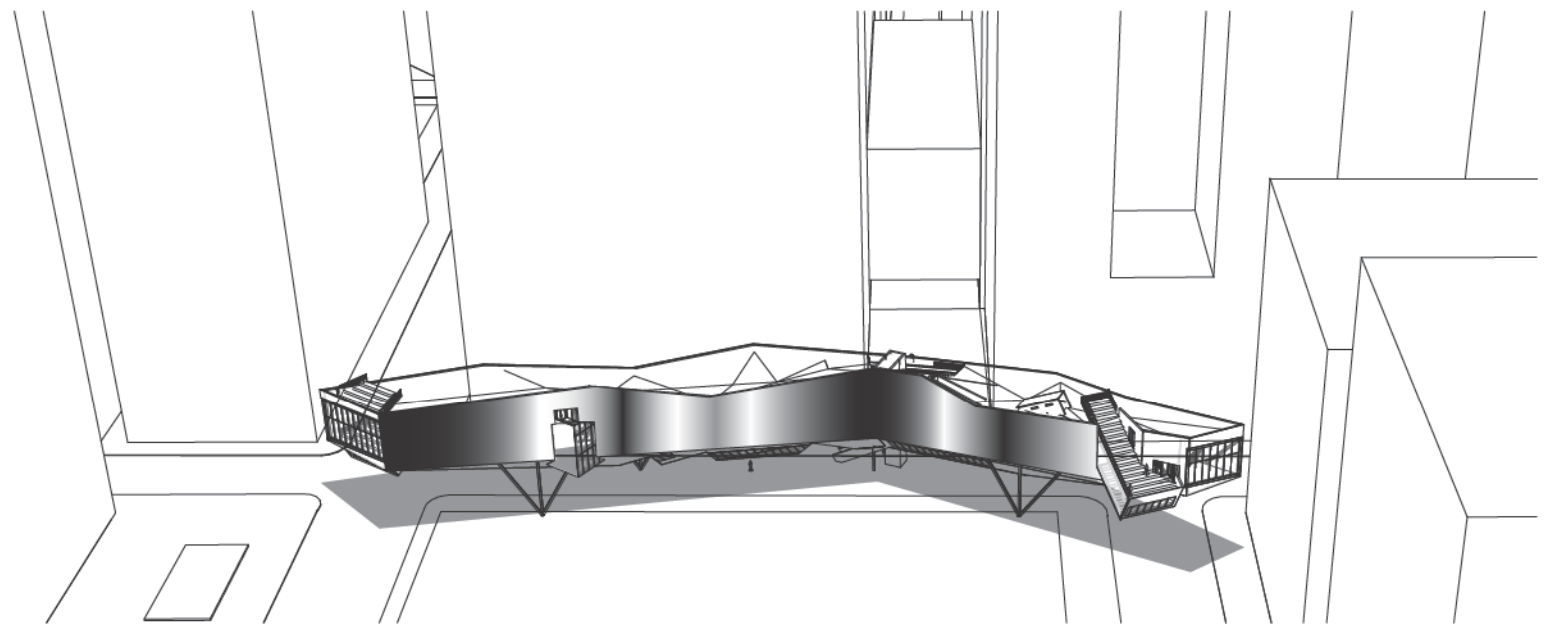
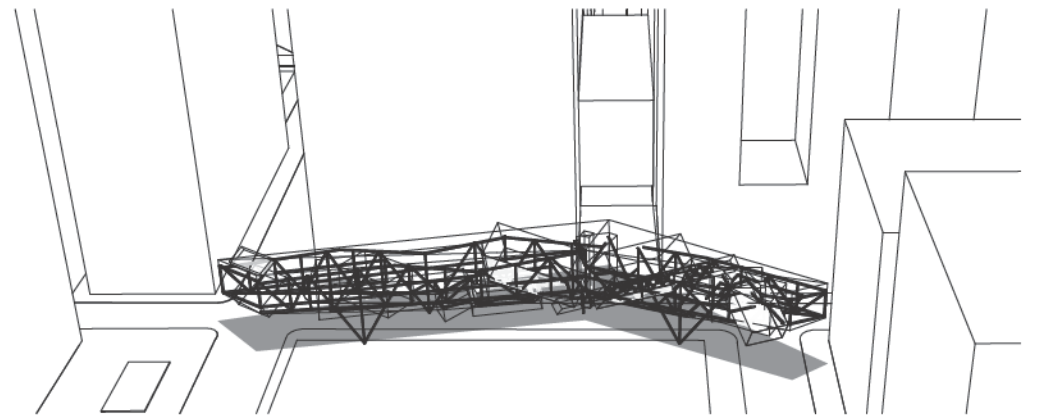
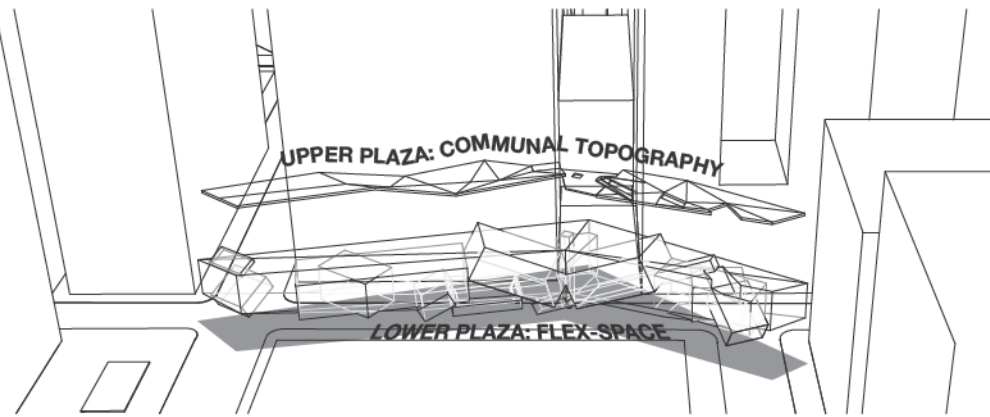
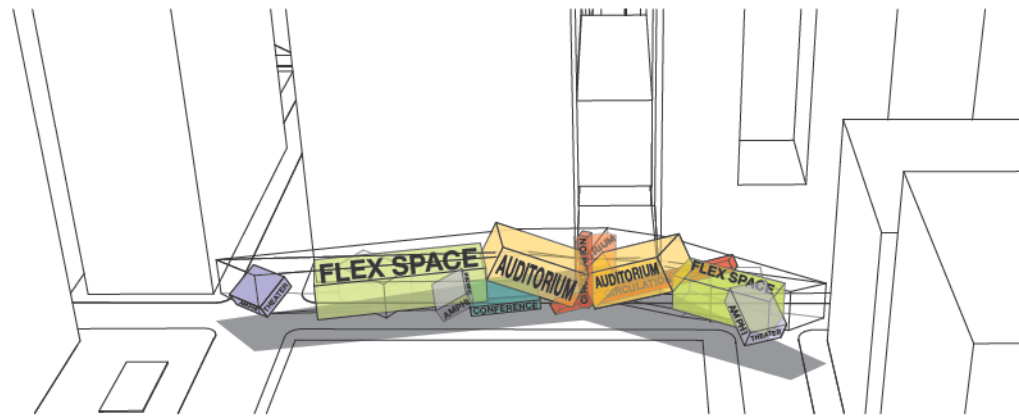
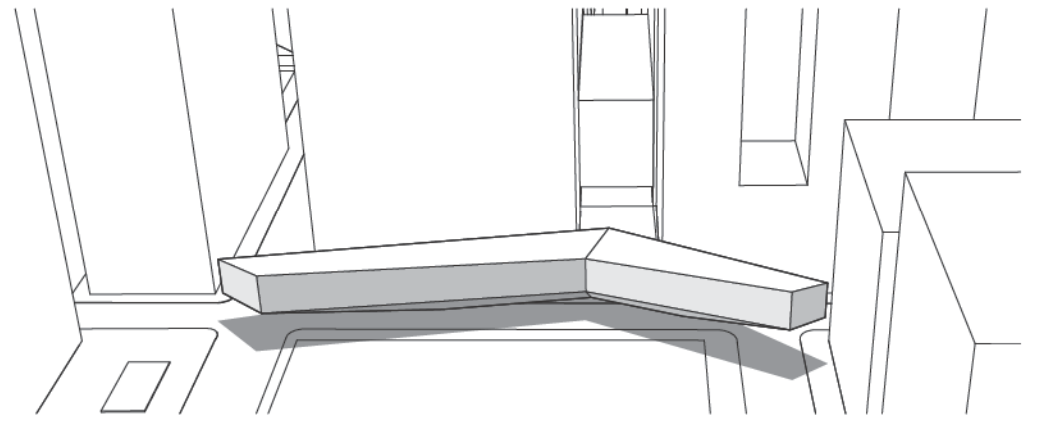
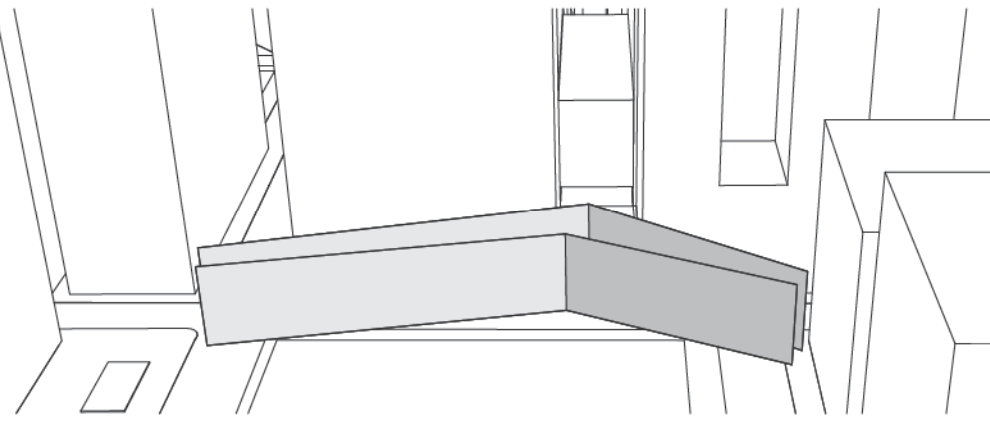
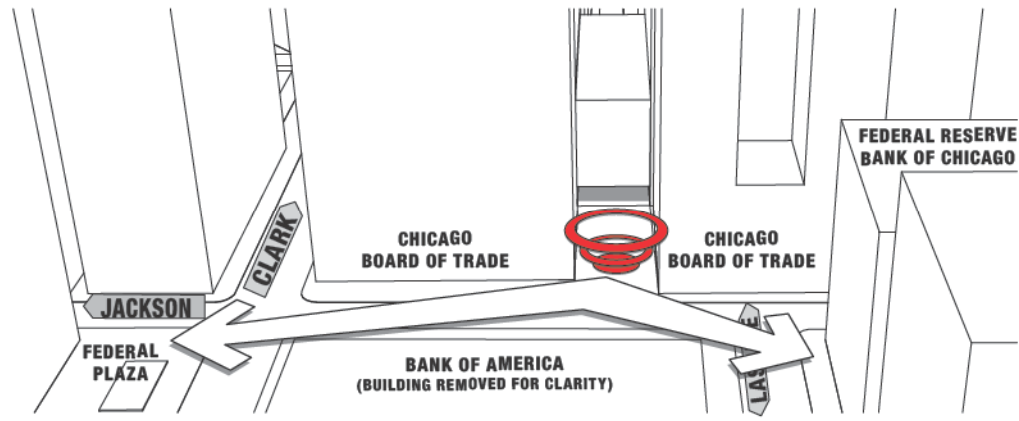

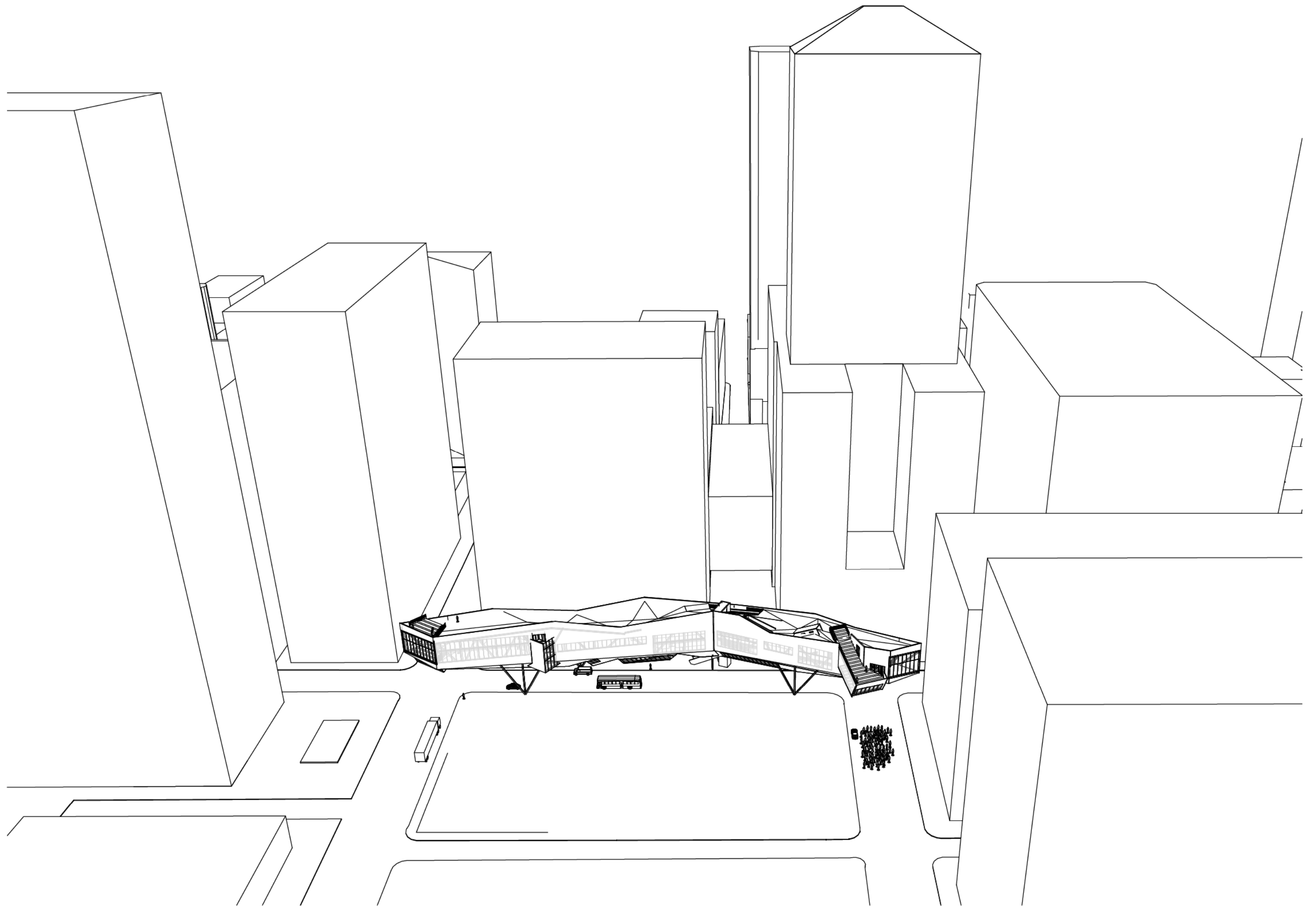

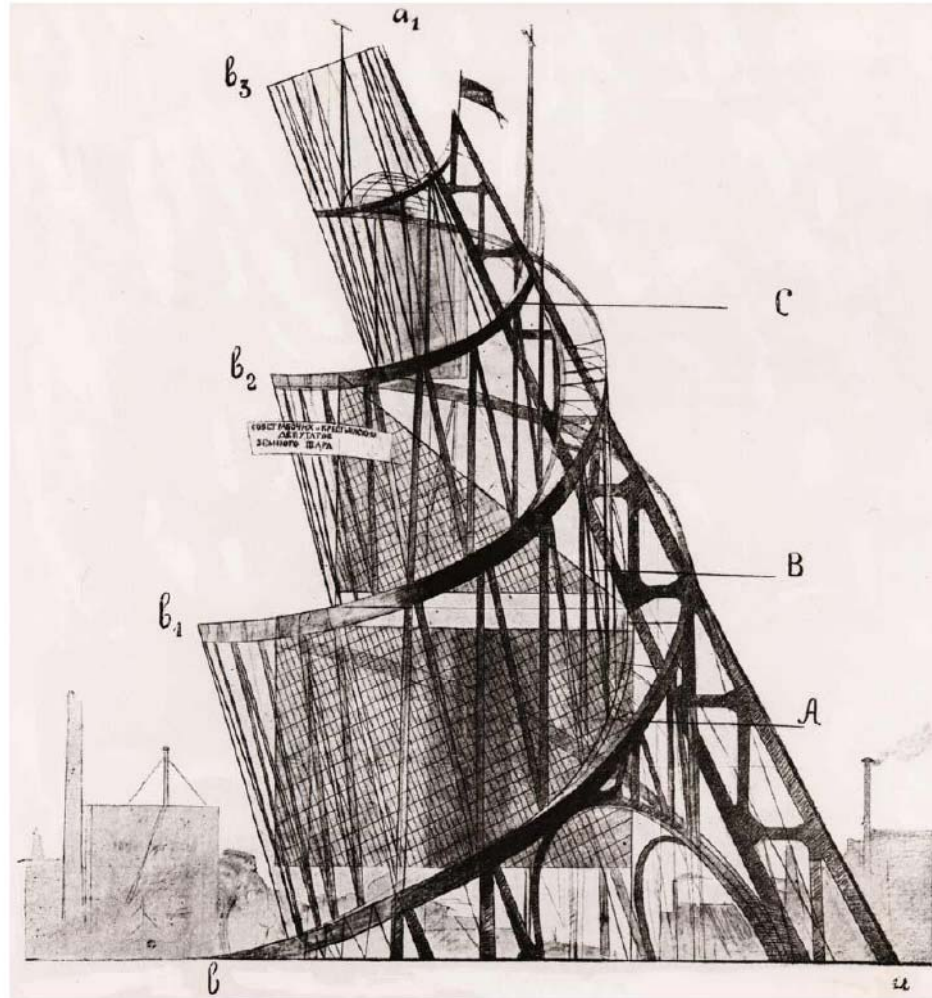

4TH FLOOR PLAN

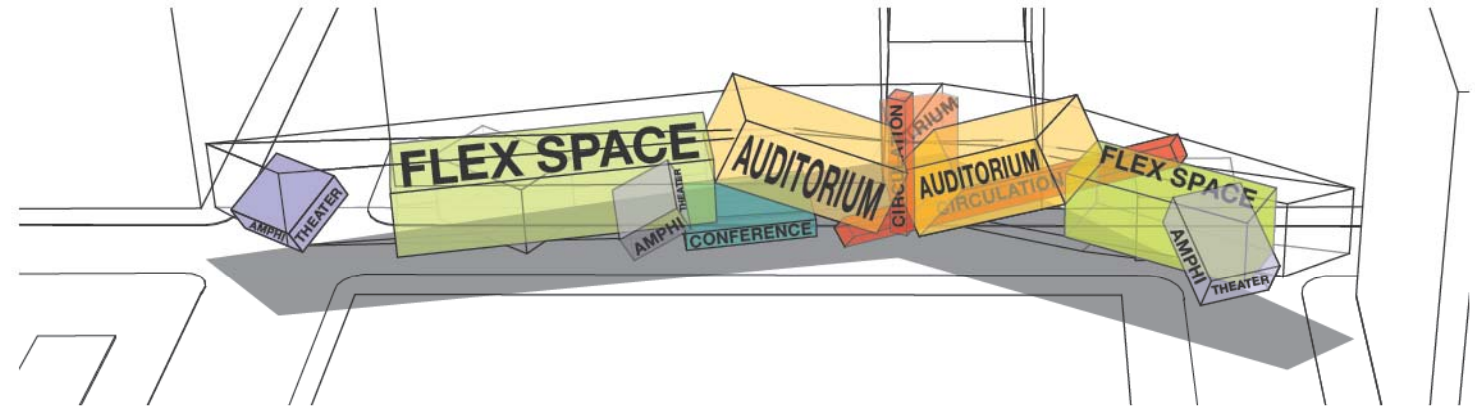
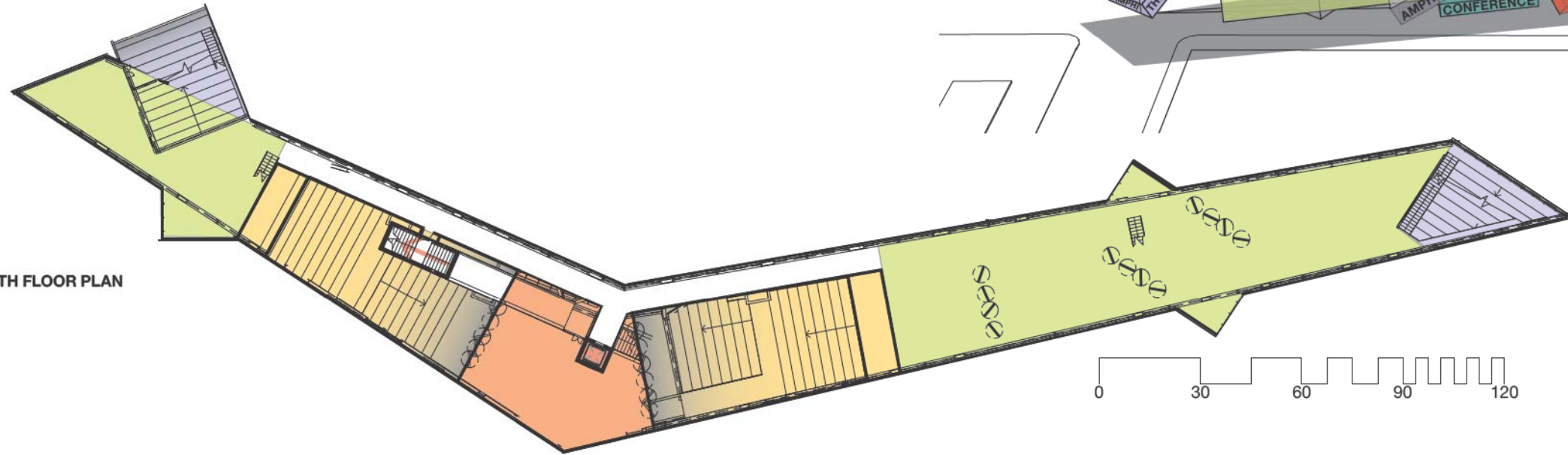

SECTION

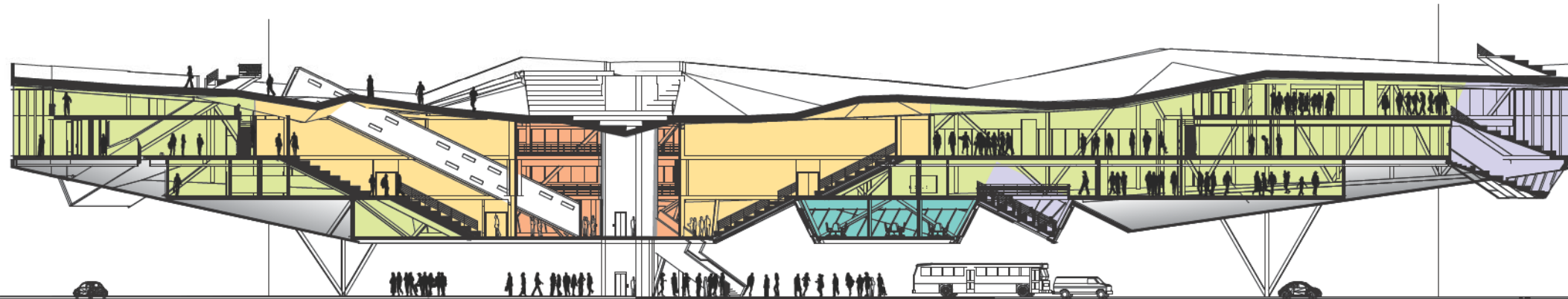

SOUTH ELEVATION

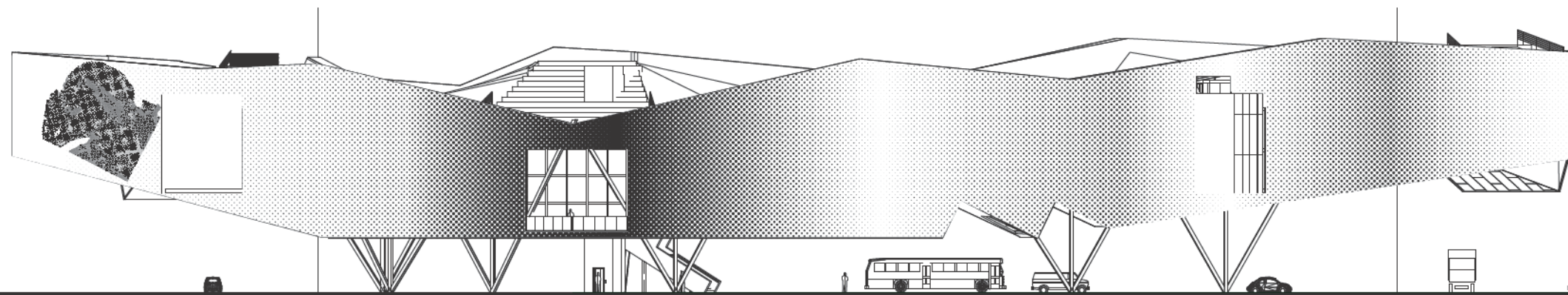

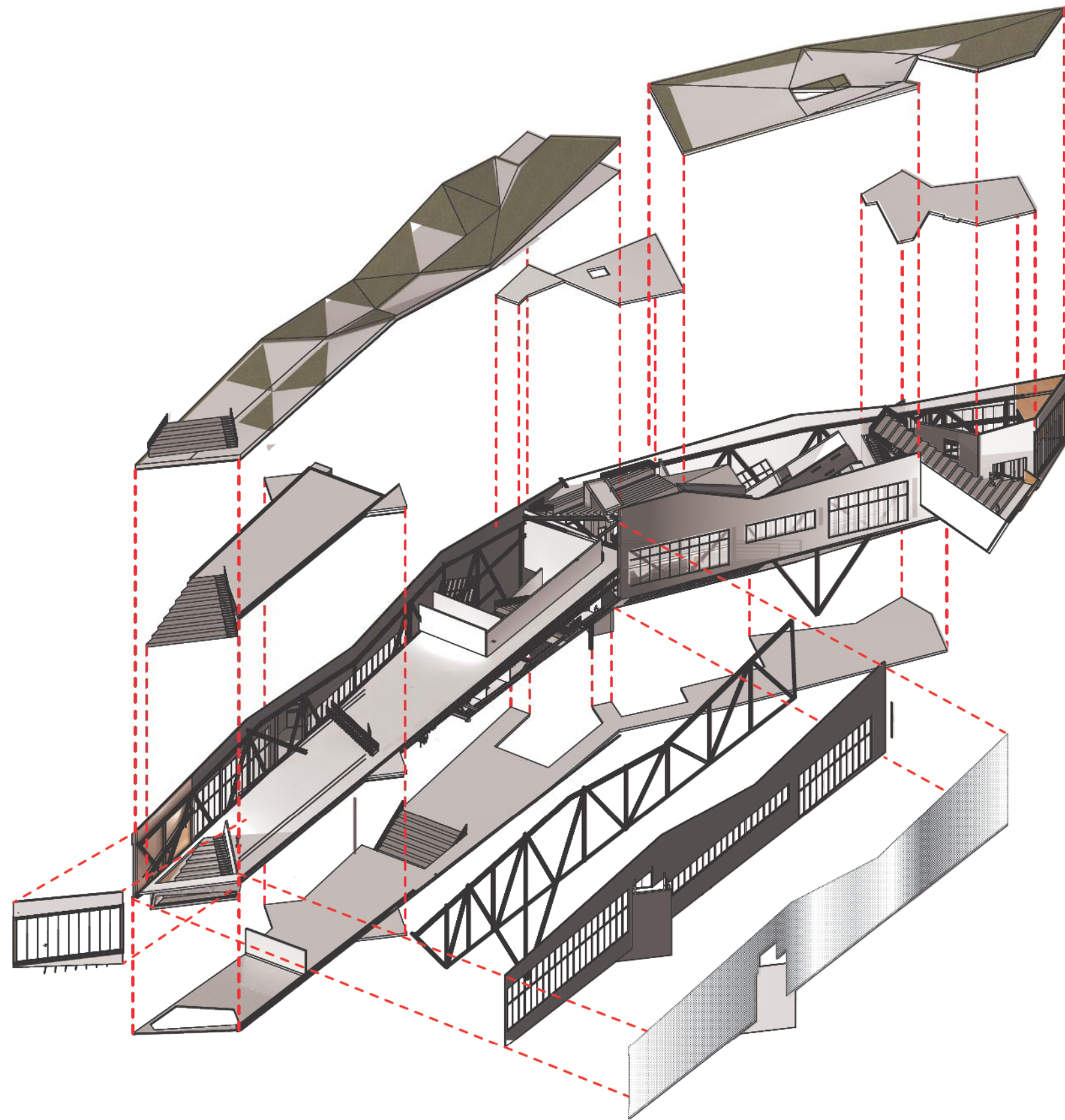

SKIN JOB

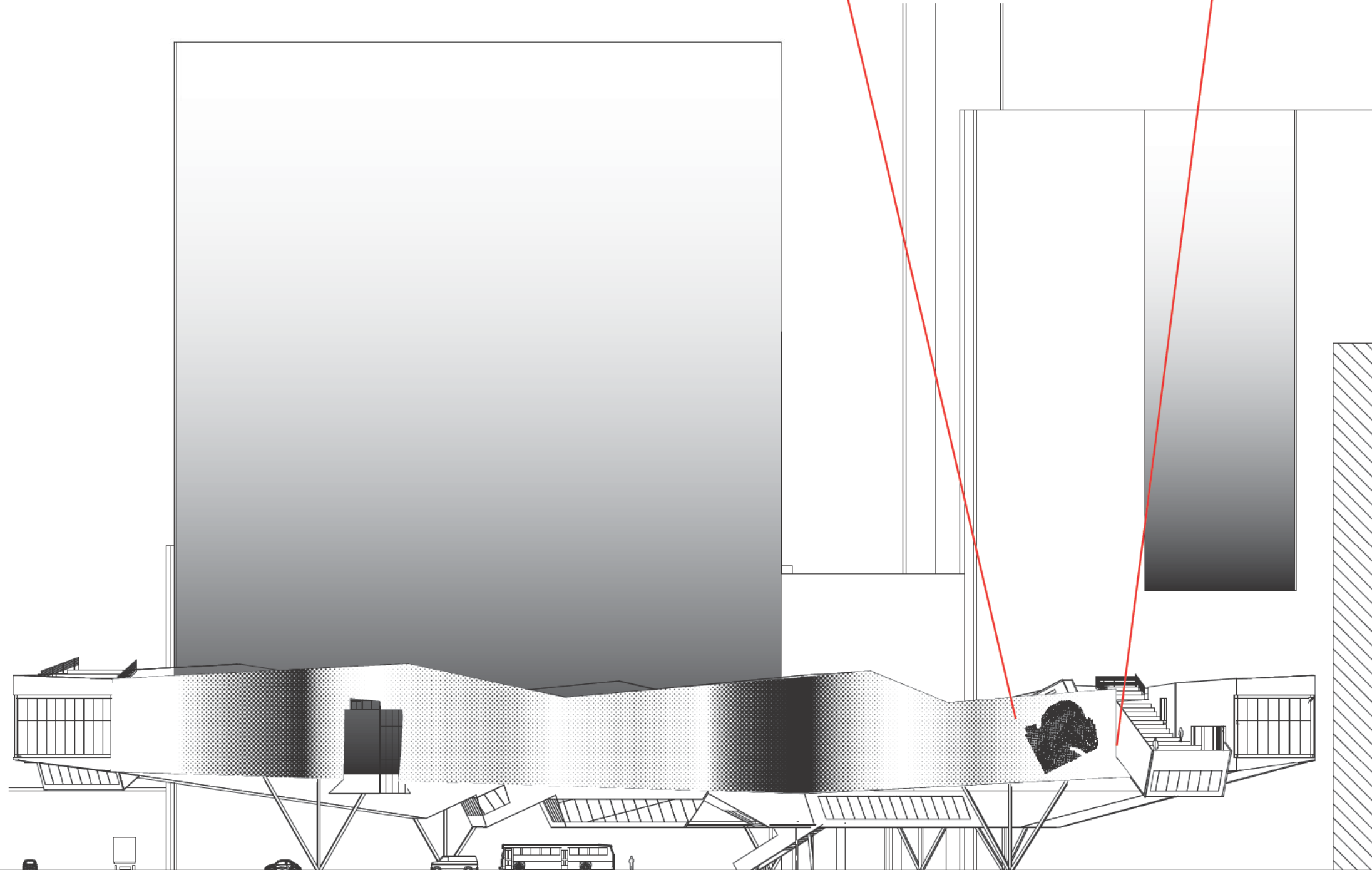

NORTH ELEVATION

