

NUTRITION
health
WELLNESS

urban

community involvement

k-8

fitness

exposure

OPPORTUNITY

activity

environmental awareness

charter

CHICAGO

school

When approaching the masters project I became very interested in the idea that the physical environment could effect the way that we learn. Many schools in America are so out of date that they do nothing to support the way we teach (or should be teaching) in the 21st century.

My project is a K-8 school located on the southwest side of Chicago in the Garfield Ridge neighborhood. The school is a charter school which means that although it receives public money, it is not subject to the same rules and regulations that apply to other public schools.

In exchange, the school has to produce certain results which are determined by each schools charter. Beyond academics, the school will focus on wellness instruction and ecologically based practices throughout the school to encourage students to develop healthy and sustainable lifestyles for themselves and their families. The school building itself will remain open after regular teaching hours and on the weekends in order to provide a much needed community space for the neighborhood.

The idea of a school focused on health and wellness stems from the shocking statistics about childhood obesity and the need for children to be taught from an early age about ways to avoid such a fate. Another surprising fact is the diminishing presence of recess in city schools, despite the many studies which show that periodic physical activity helps students to concentrate better and retain more information. The school will take on a holistic approach to learning, where the student not only learns academic subjects, but also how to be a healthy, productive individual in society.

why?

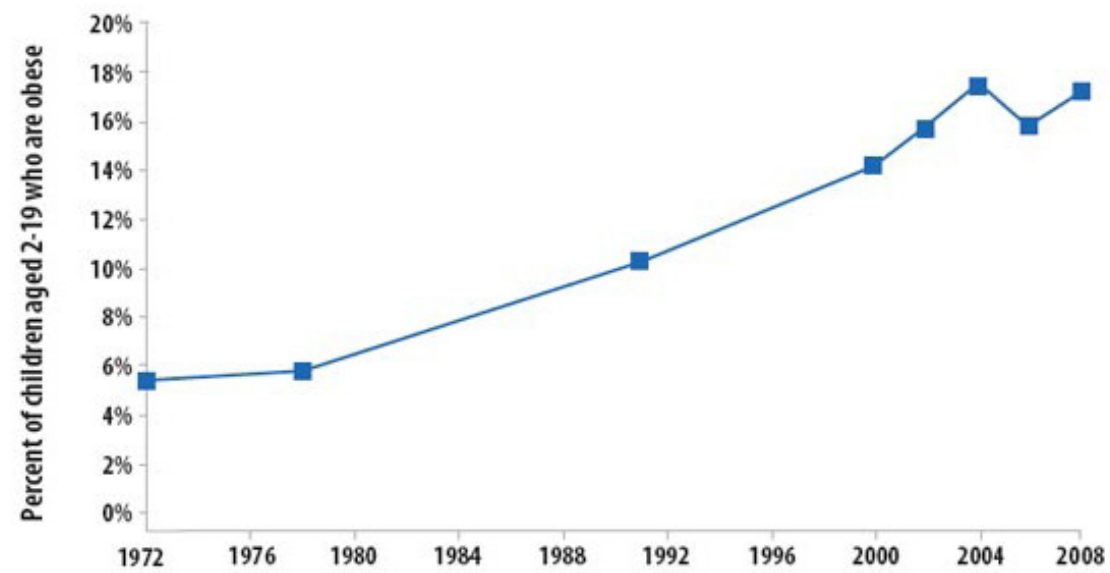

Source: CDC, National Center for Health Statistics, National Health and Nutrition Examination Surveys.
Note: Obesity is defined as BMI \geq gender- and weight-specific 95th percentile from the 2000 CDC Growth Charts



childhood obesity has more than **tripled** in the past 30 years.



only **37%** of cps schools have recess

The Academy for Global Citizenship

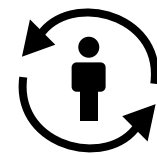

serving the whole child



modelling academic excellence



fostering environmental stewardship



developing inquiries



cultivating global awareness



community collaboration

The Edible Schoolyard

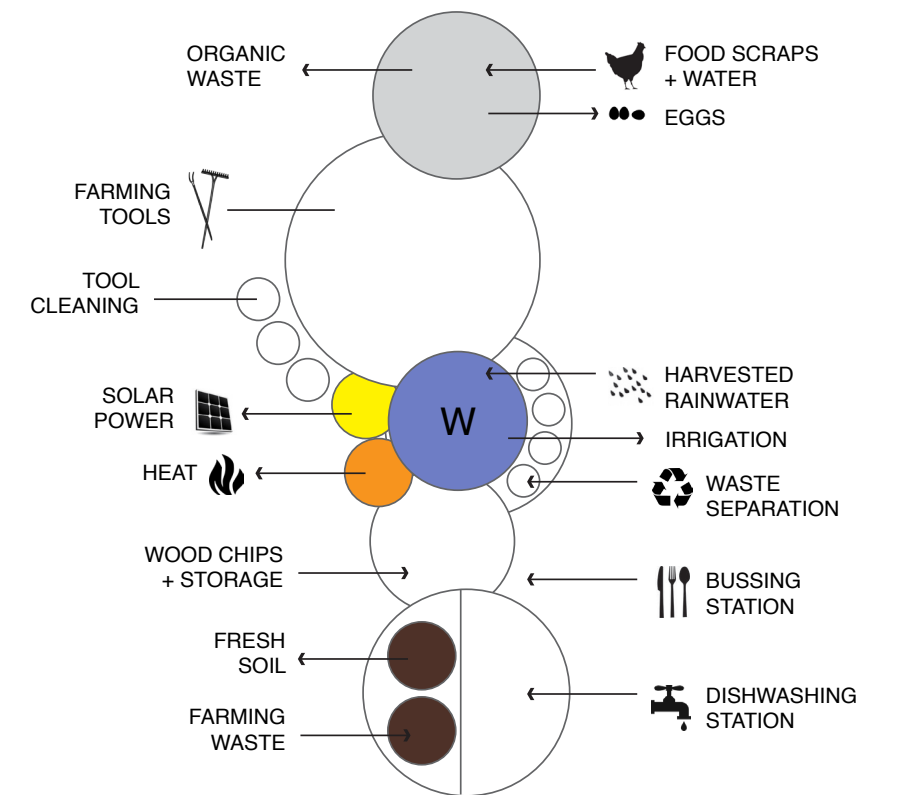

The school will be located at W 46th and S Lavergne; four blocks West of Cicero Ave. and about two miles north of Midway airport. The new building replaces an existing school on the same site. The site is large, spanning two blocks by two blocks. I propose that the second building on the site be converted into either a vocational high school which focuses on health related professions or a culinary school. At the Southern end of the site, land will be preserved for future development which would support the surrounding program. For example, a health food store or a fitness center could be possible options for this development.



single family bungalows

W 46th St

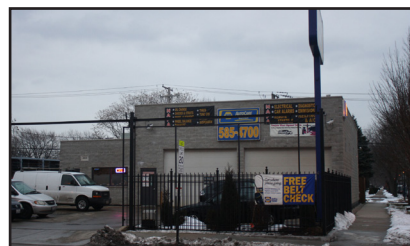

Napa Auto Repair



Hearst Elementary



Napa Auto Parts



Caro Taqueria

ACCESS COMMUNITY HEALTH NETWORK



S Cicero Ave



S Leclaire Ave

S Lawler Ave

S Lavergne Ave

S Lanone Ave

S La Crosse Ave

W 47th St

W 48th St





AGC (current annex location)



Phoebe A. Hearst Elementary School



4941 W. 46th Street
Chicago, IL

K-4 (grow to K-8)
190 students in 2 locations
(grow to 340 students)

Charter School

"Our mission is to empower students to positively impact the community and world beyond by encouraging learners to develop healthy and sustainable lifestyles for themselves, their community and our planet".

Demographics

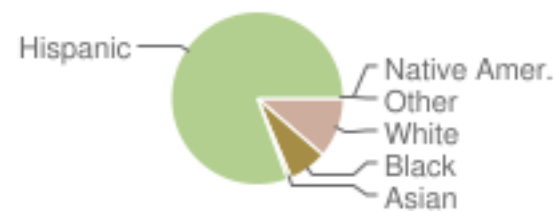

Statistics



4640 S Lamon Ave
Chicago, IL

preK-8
289 students

Fine Arts Magnet School

Track "E" year round learning

The traditional school calendar has a 10-week summer break. Students enrolled in the year-round Track E program have the same number of school instructional days, but, student vacations are interspersed throughout the year into shorter, more frequent breaks.

Partnered with Jane Addams Hull House Association

Goals including providing community members with support and opportunities to promote children's learning and development, aligning out-of-school time programming with classroom learning, bringing schools, families, and communities together by working towards common goals and coordinating the access to and provision of resources to children and families using schools as hubs.

Statistics



Demographics

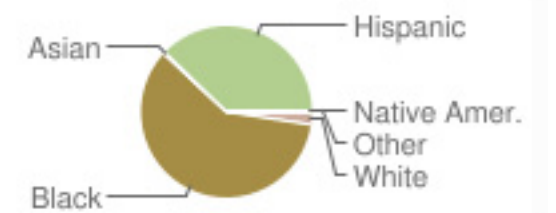

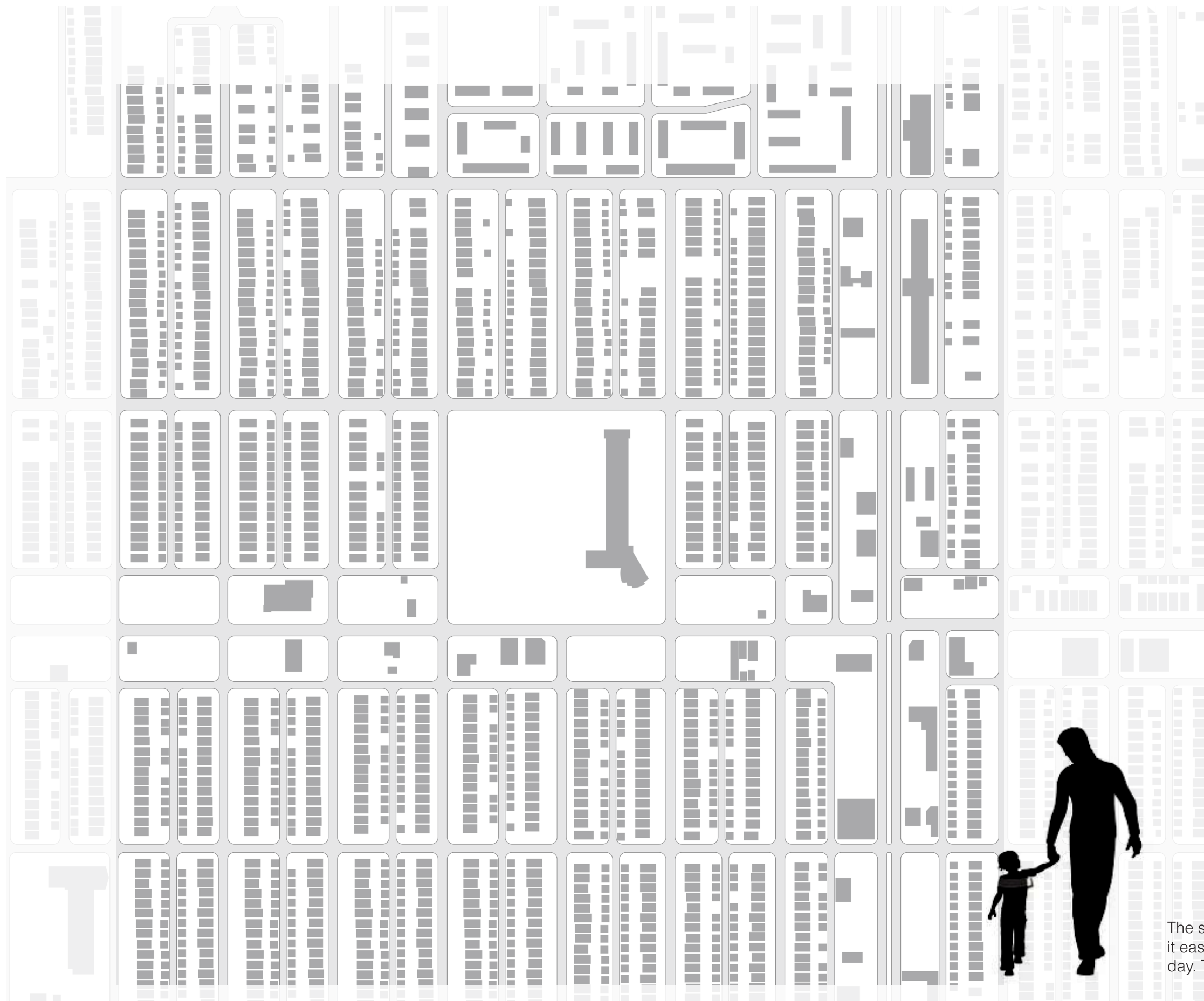

The site is located in the center of a residential neighborhood, making it easy and safe for children attending the school to walk there each day. The map shows a quarter mile walking radius.

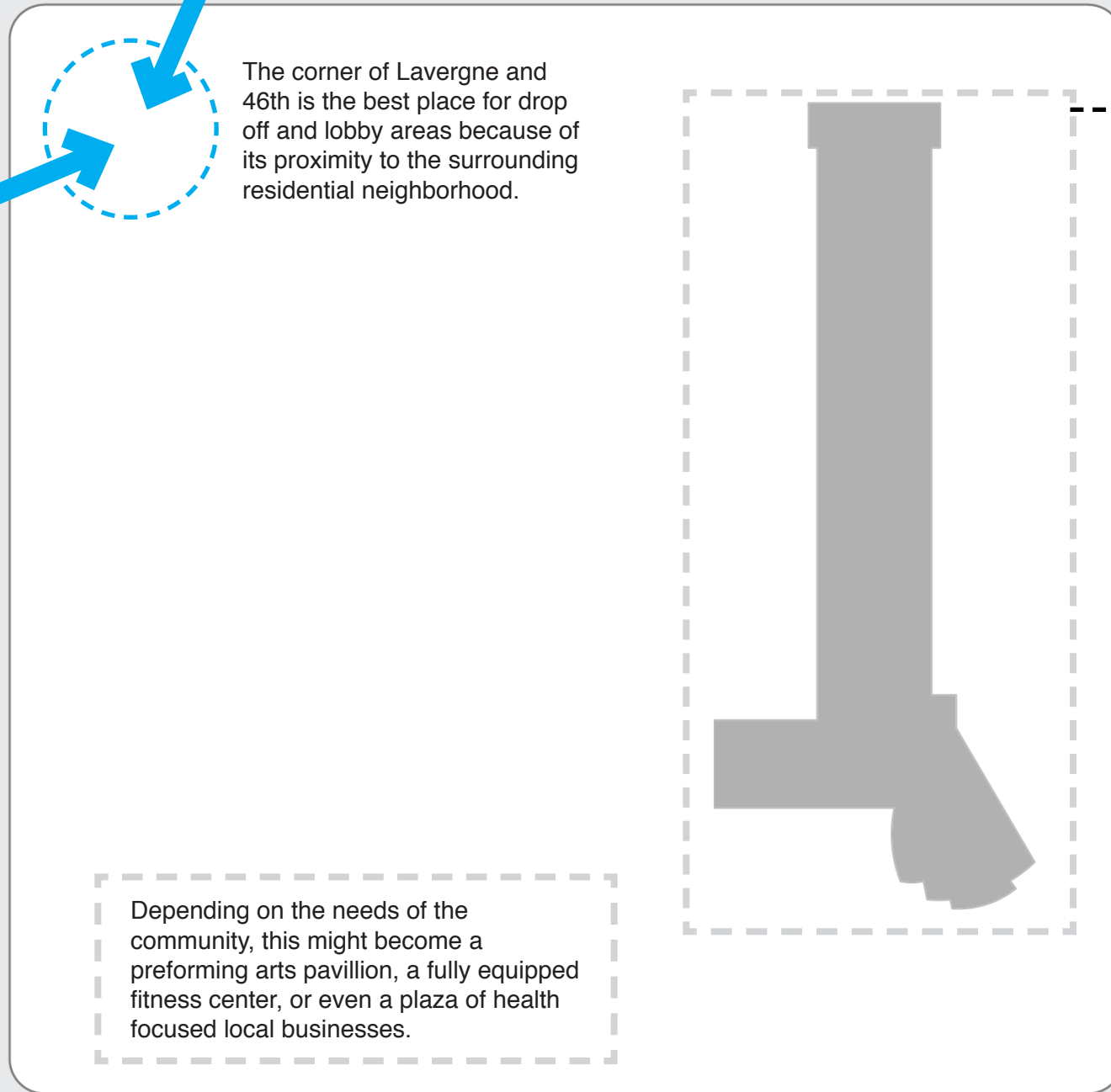
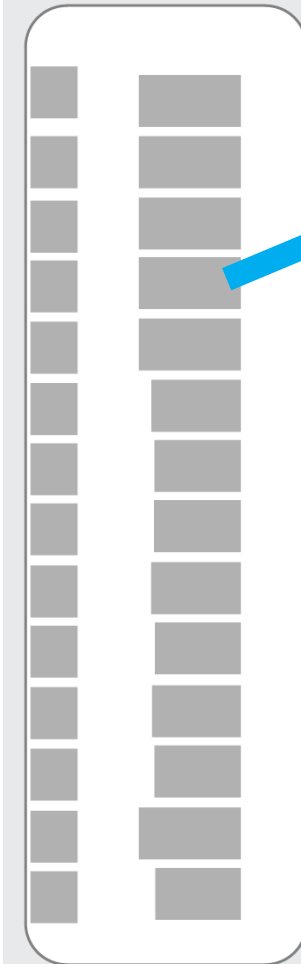
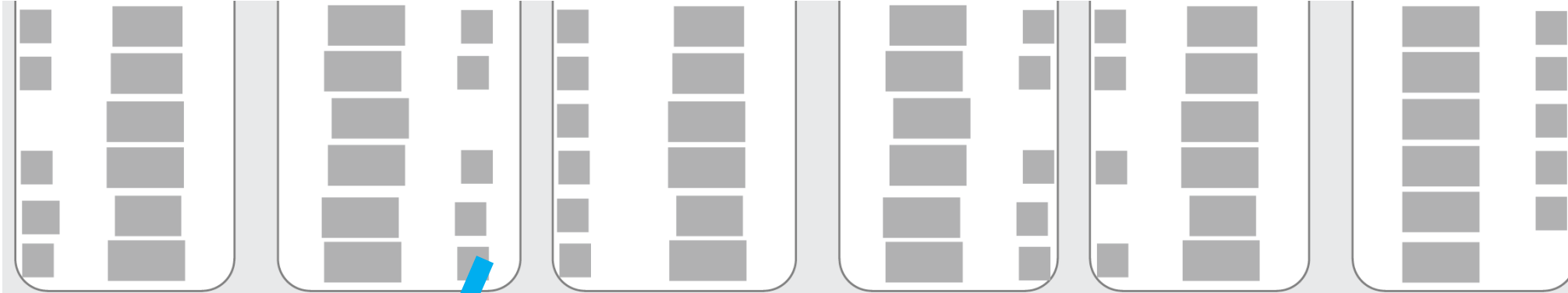

The corner of Lavergne and 46th is the best place for drop off and lobby areas because of its proximity to the surrounding residential neighborhood.

Depending on the needs of the community, this might become a performing arts pavillion, a fully equipped fitness center, or even a plaza of health focused local businesses.



So not to compete with the new k-8 school, the current Hearst Elementary will be adapted to become a new vocational high school which prepares students for careers in the health professions.



← 47th St is the busiest of the four surrounding streets. It is best to avoid situating the school along this edge for safety reasons.

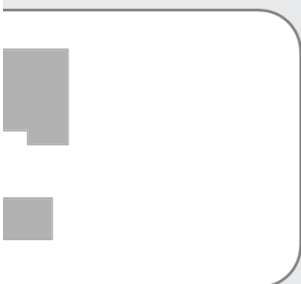
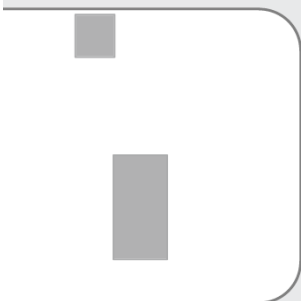

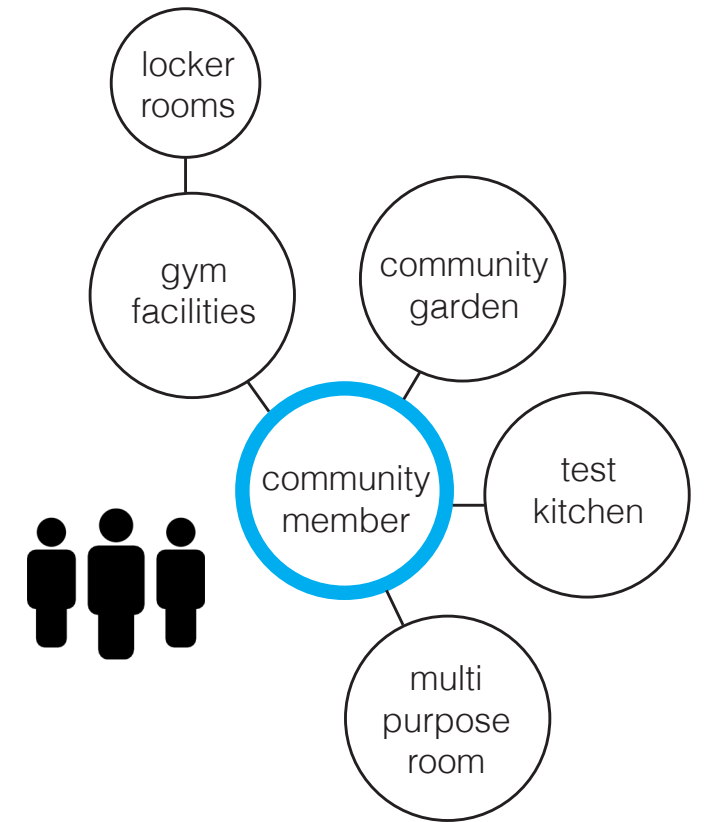
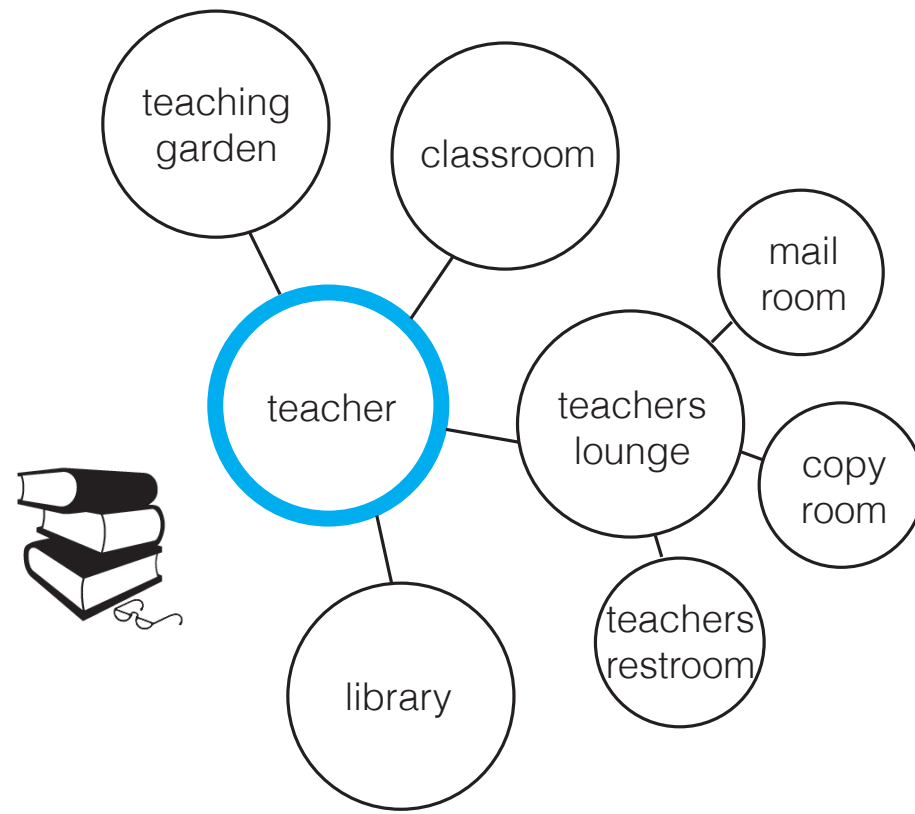
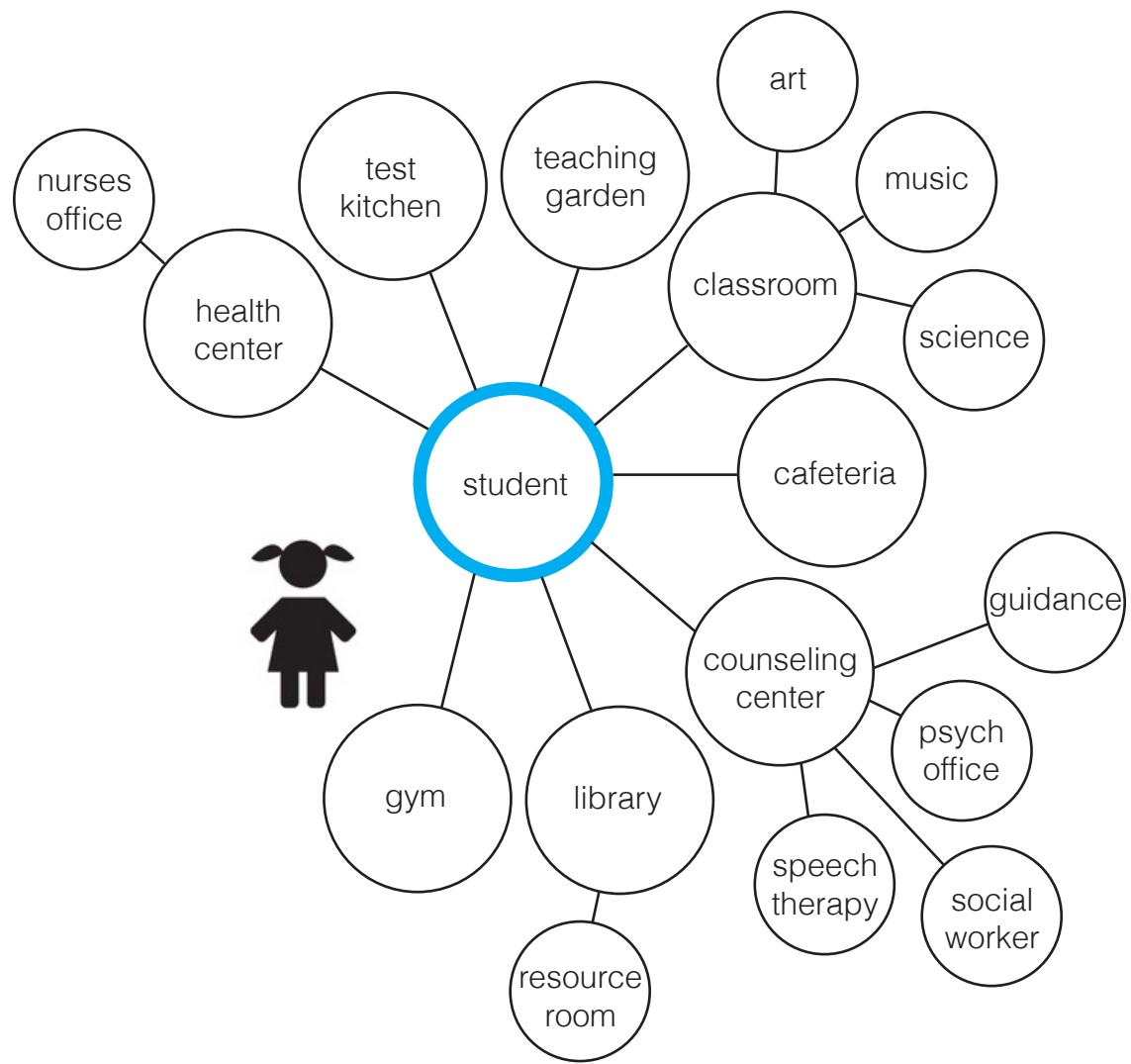

Sandal Magna community primary school

Wakefield, England



Sidwell Middle School

Washington D.C.

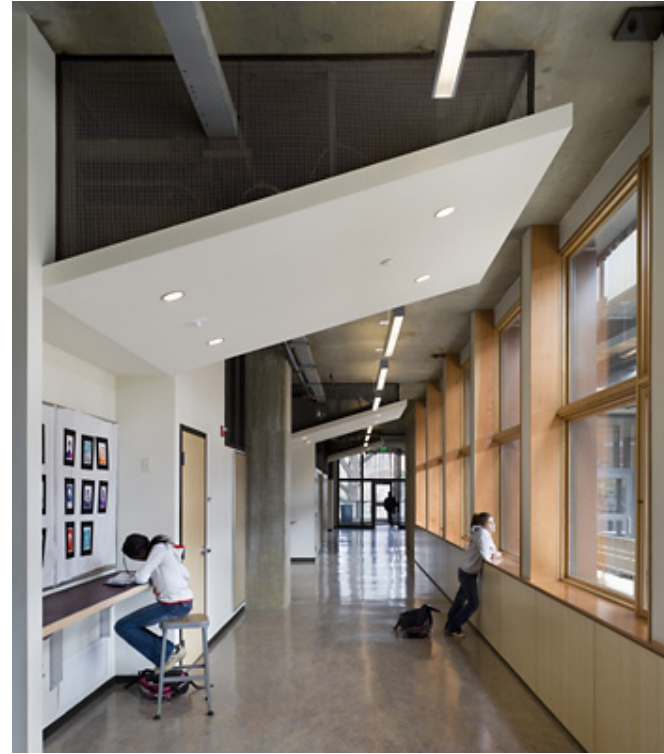

Samuel Brighthouse Elementary School

Richmond, British Columbia

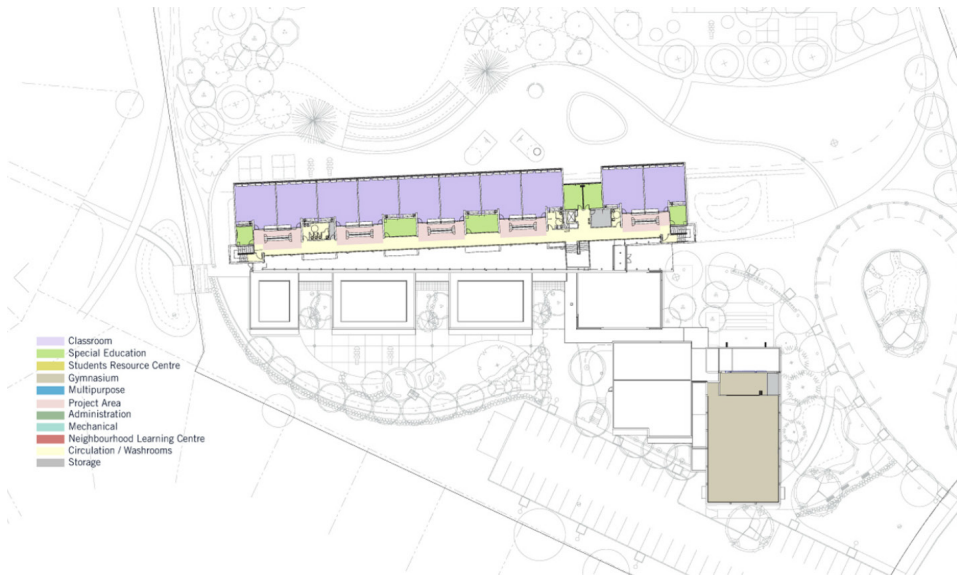
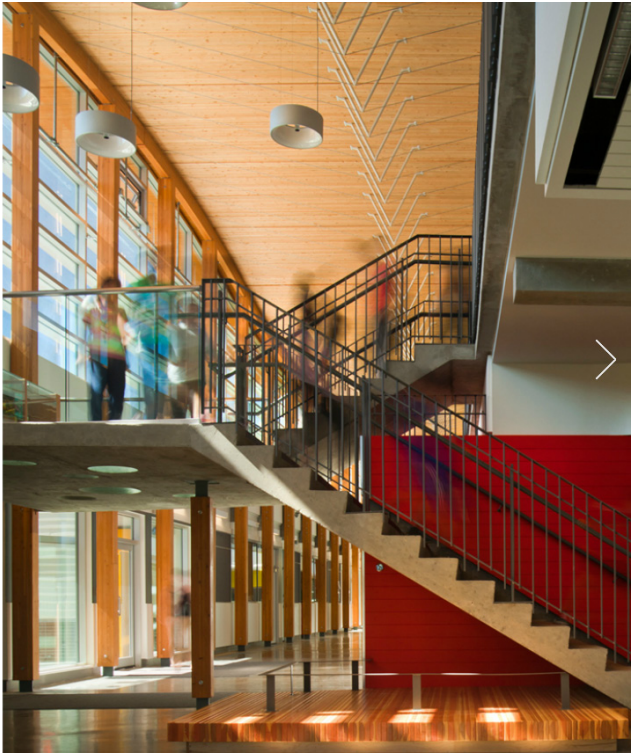

The concept behind the design is based on the idea of “growth”. Children spend a significant amount of their childhood at school; it is where they do a lot of growing up (academically, socially, mentally and physically). How can the architecture of the school cater to all of the changes that a child will go through during their time there? From the flexibility needed day to day to the big changes that occur through the years, the school will reflect the constant need for shifting and transformation. The idea of growth can also be extended to other aspects of the project such as the schools relationship with the community. By allowing the community to become a big part of the school through volunteer opportunities and shared resources (gym, outdoor spaces, community gathering spaces), there is a growth or strengthening of relationships between community members. The more literal manifestation of growth is seen in the outdoor program elements. A combination of teaching and community garden space brings fresh, healthy foods to the students and the neighborhood.

to **grow**:

(v)

1. to increase in size by a natural process
2. to develop and reach maturity
3. to come into existence from a source;
spring up
4. to come to be by a gradual process
or by degrees; become

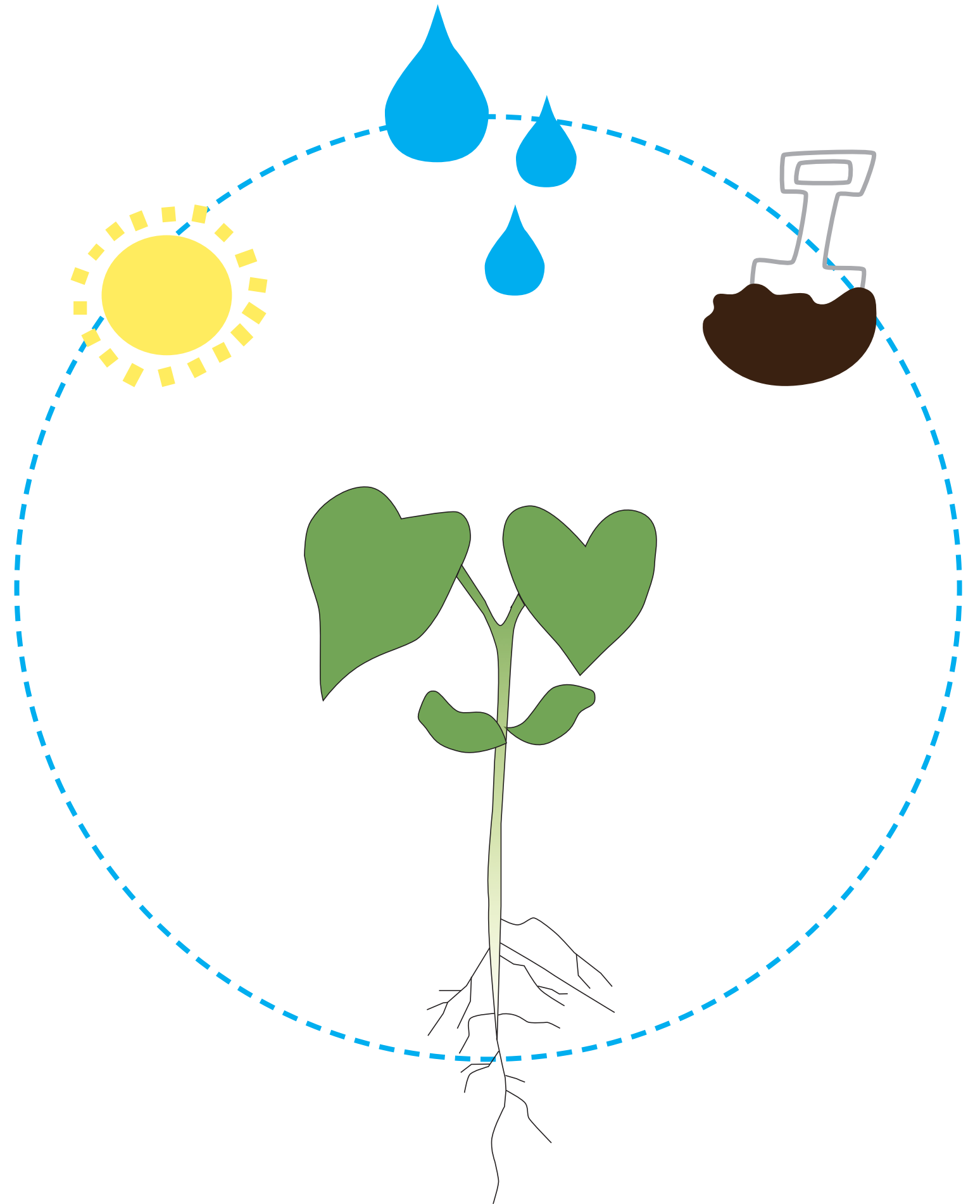

the **child:**

social

learn how to interact with peers
sharing, respect, patience
solving behavioural issues
manners and etiquette

cultural

learn to accept people of different backgrounds
experience cultural traditions, foods, etc.
understand diversity

creative

learning through free play
imagination
exploration
experimentation

physical

refine motor skills
learn about health and wellness
importance of sleep
puberty

emotional

dealing with personal issues
how to decipher different emotions
coping with separation (preschoolers)
how to handle stress
teaching morality

academic

preparation for high school
individual learning styles :
verbal, visual, tactile, kinesthetic, and aural
well balanced subject matter



the **community:**

The school building becomes a central hub for activity within the community. Operating most hours of the day, it offers programs for students, parents, even residents without children. Many of the activities are focused on wellness and creating spaces for social events; encouraging the development (growth!) of strong neighborhood relationships.

In the future, it is proposed that the current Hearst Elementary school could be converted into a vocational high school with programs focused on preparing students for careers in the Health Sciences or a culinary school.



the **landscape:**

community garden
playground [natural]
playground [energy producing]
orchard
food cycle



The design lends itself to a landscape which is laid out as a patchwork on the site. Each patch contains a different type of outdoor environment which relates to the indoor space it is adjacent to. For example, the central courtyard space acts as an extension of the cafeteria and provides an outdoor seating and socializing area for the students. A quiet meditation garden is located between the library and teachers work area and is reached by walking along the path through a planting of native grasses. The vegetable and herb garden takes up a large portion of the site and provides a space for hands on learning and also community involvement.

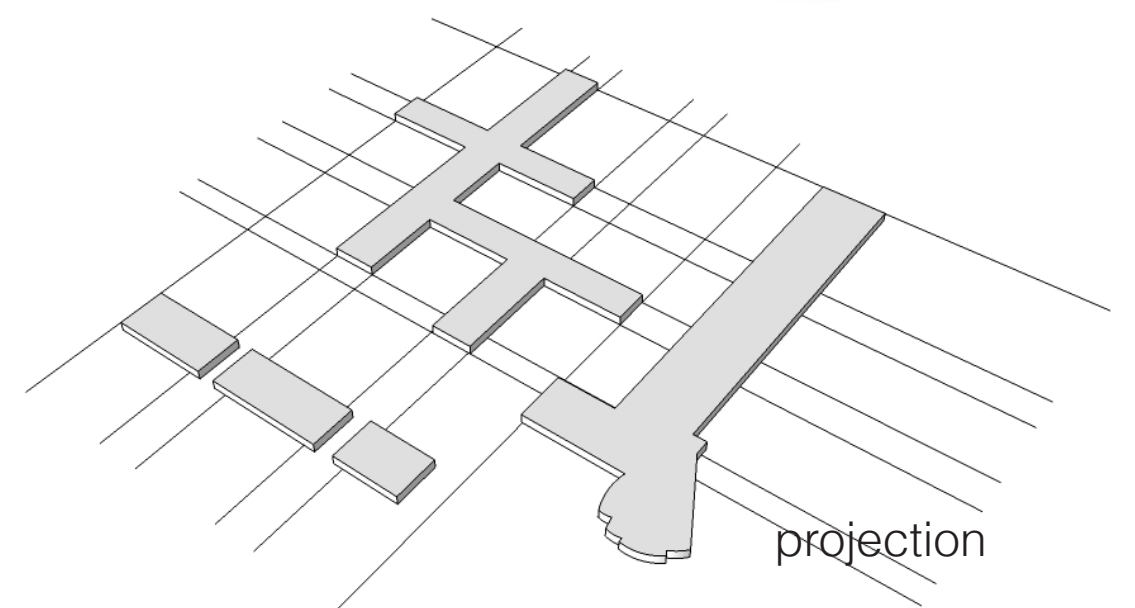
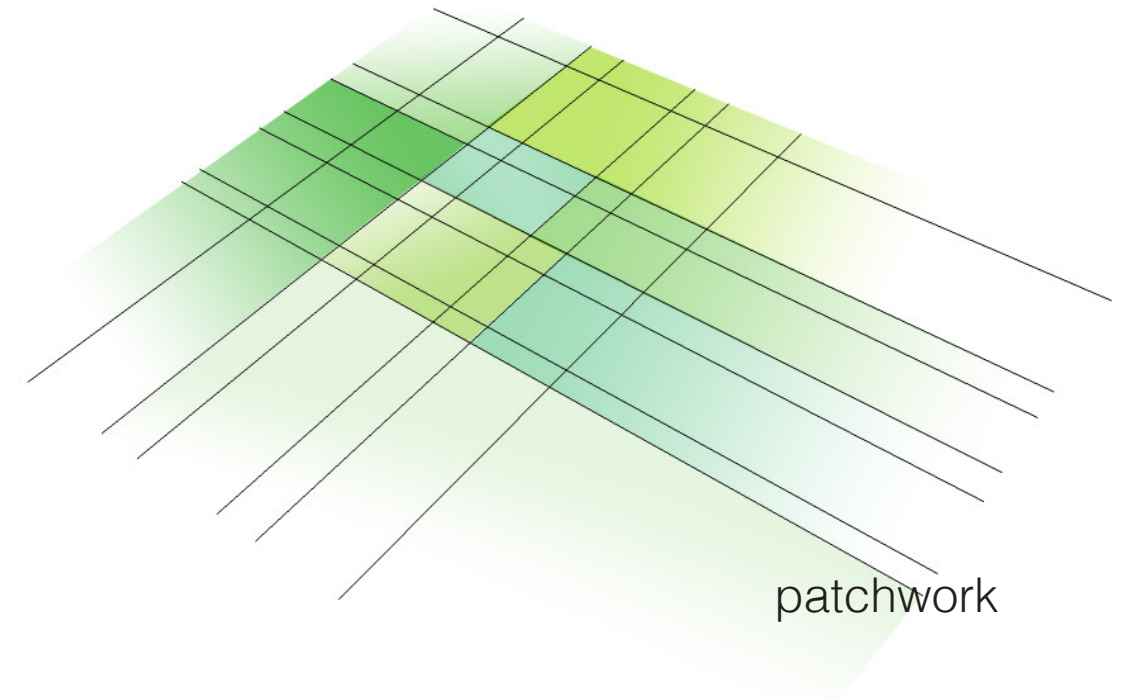
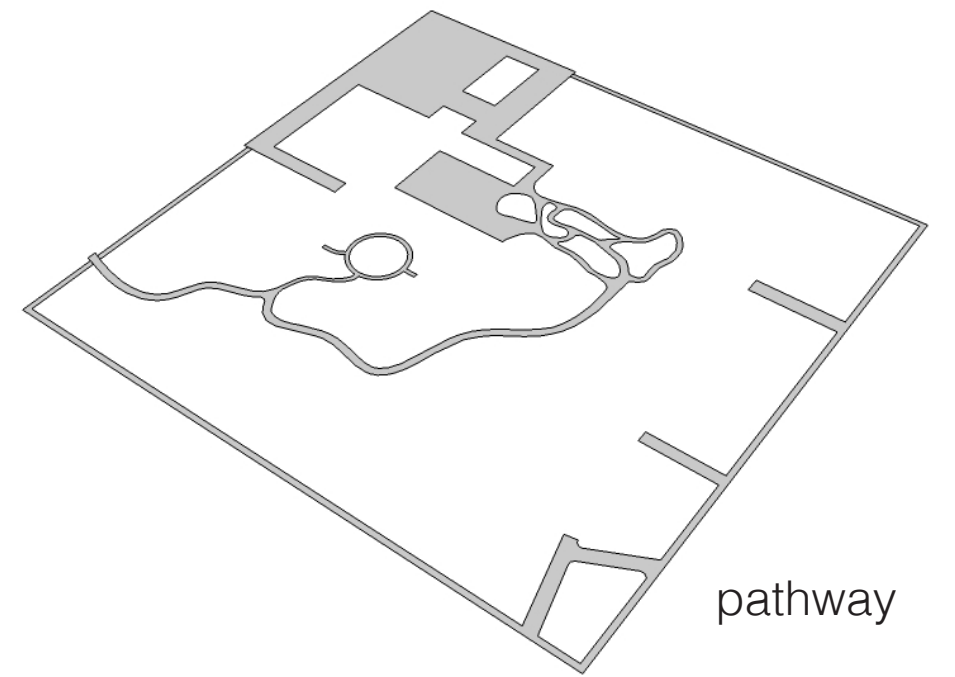
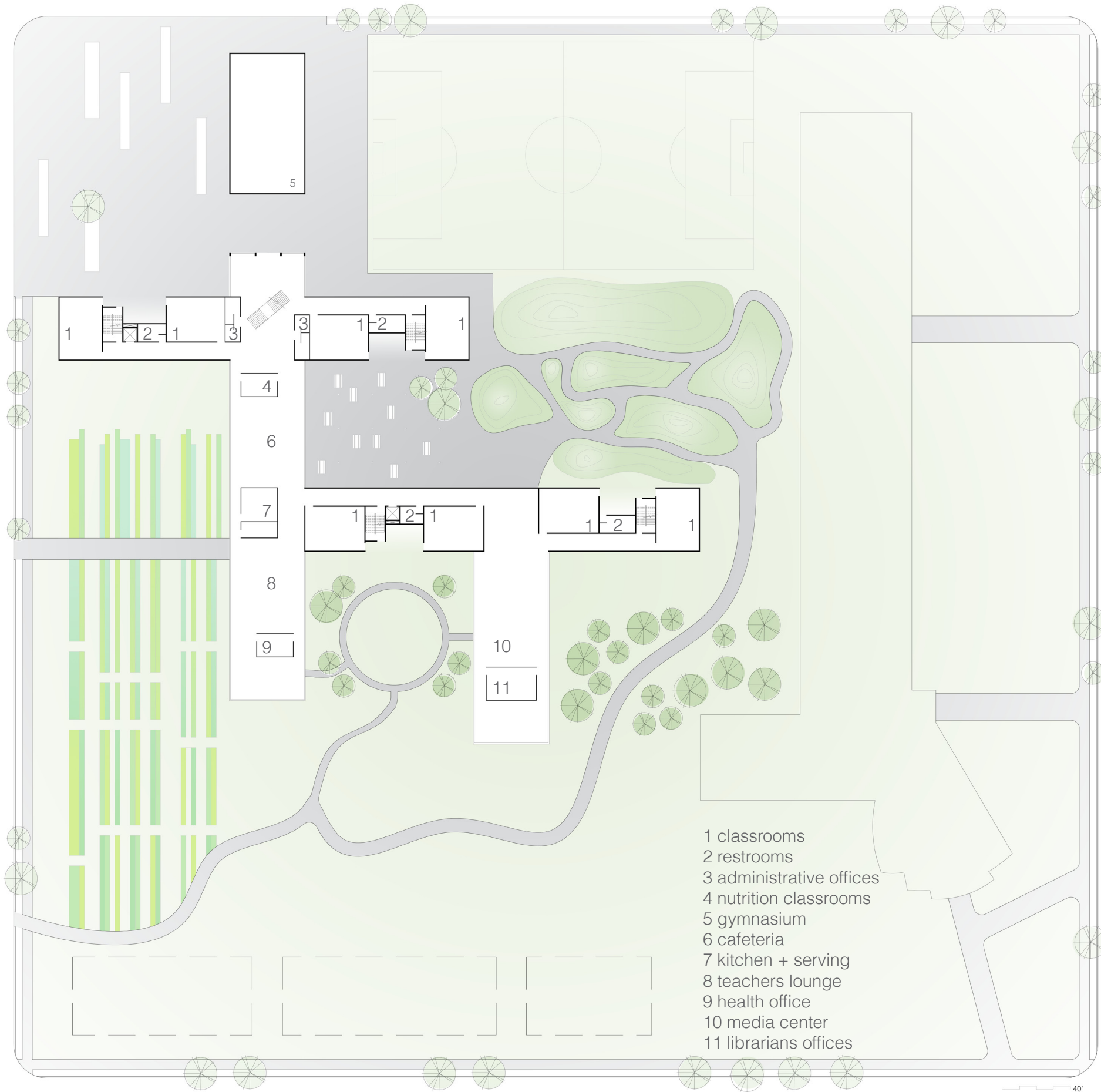

Landscape Precedents

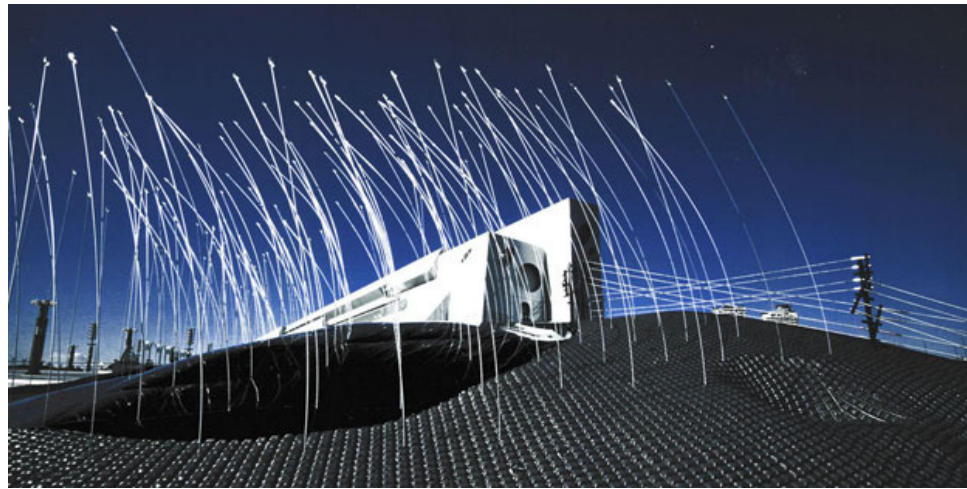

Fiber Wave
Makoto Sei Watanabe



Shenyang Jianzhu University Campus
Turenscape



Patio Garden Cirqada
Delta Vorm Groep



Garden to the power of 10⁻⁴

The school is arranged to create diverse, flexible interior and exterior spaces which support different learning environments. Formally, the design is composed of four shifting bars. The two classroom bars are two stories high and contain four grades per bar. Within the bar, each set of two classrooms share an outdoor learning space. The remaining program is located in two light filled activity bars. Most of the spaces within these bars are not enclosed, allowing for great flexibility in their arrangement. Things like office spaces and the kitchen are treated as freestanding objects and are pulled in from the exterior walls. These objects act as barriers between the open program for sound and activity.



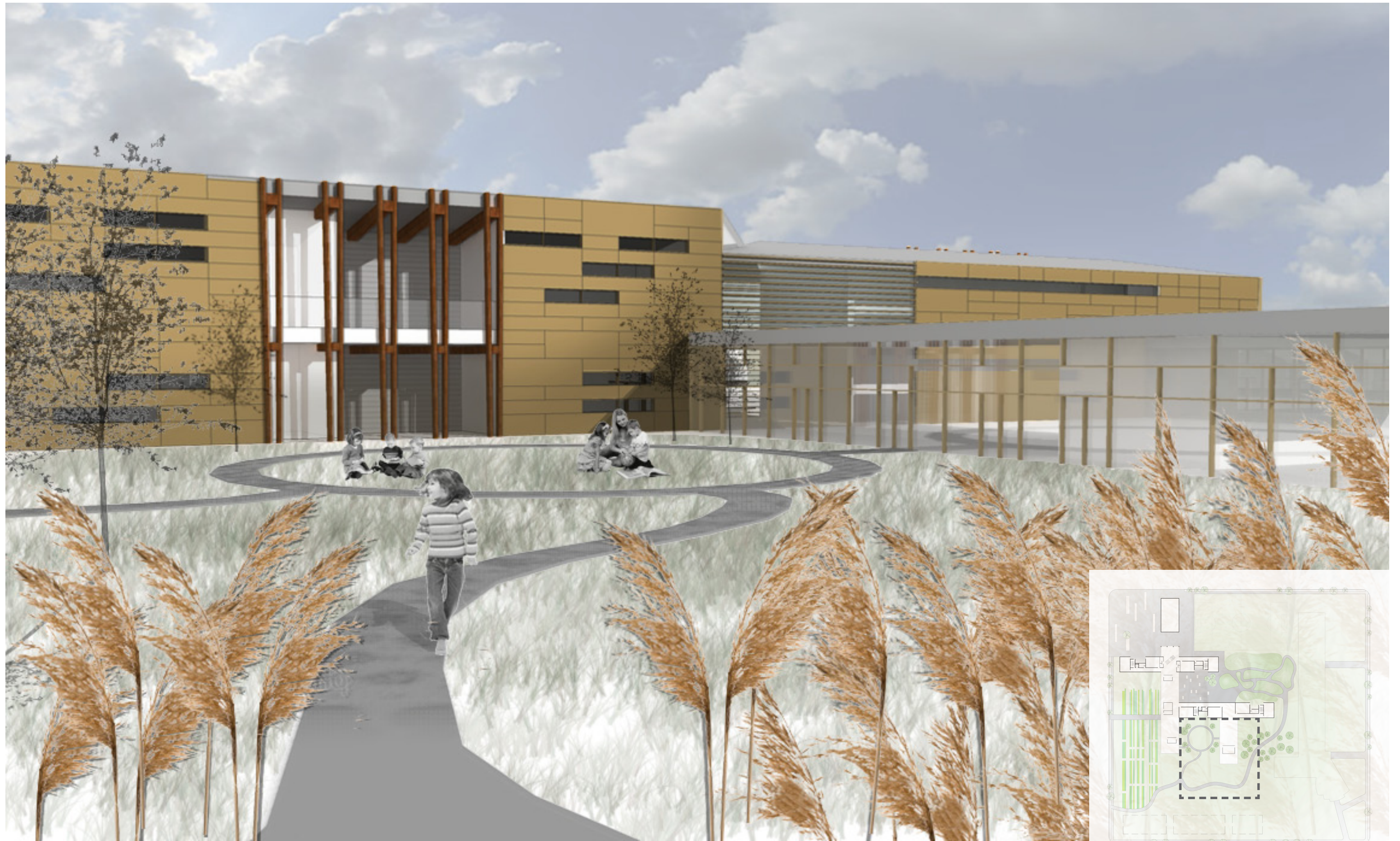



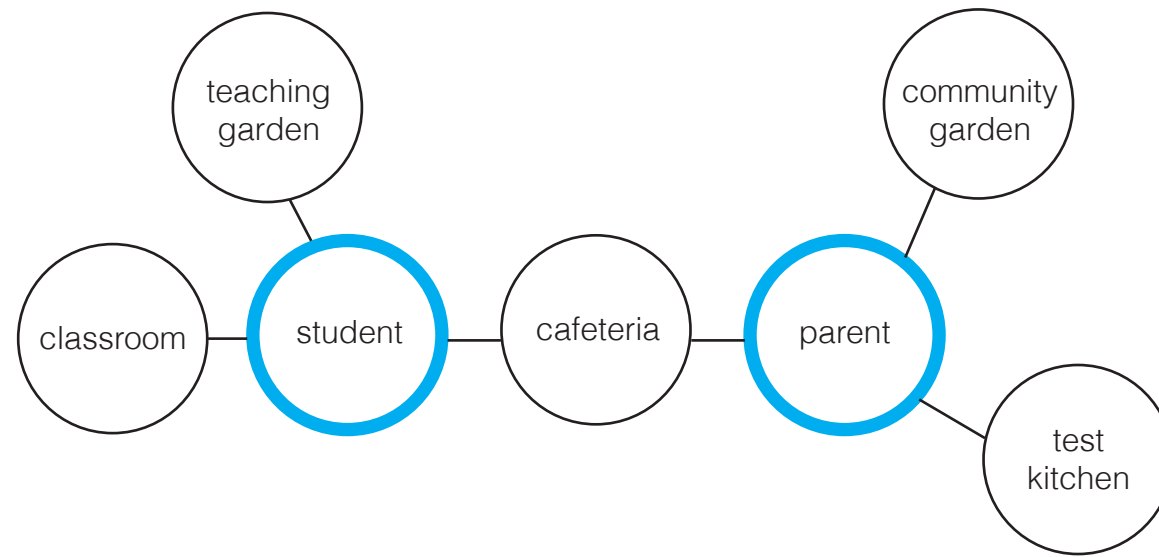

The student learns how to grow their own vegetables at school, tasting them along the way.



The student goes home and asks his/her parents why they don't buy these healthy foods?



The parent has the opportunity to attend cooking classes within the school to learn how to use different kinds of foods in their every day routine.



Parents now know what to look for at the store and are more willing to experiment at home with their cooking.



The family develops new eating habits together and is happier, healthier and more productive.

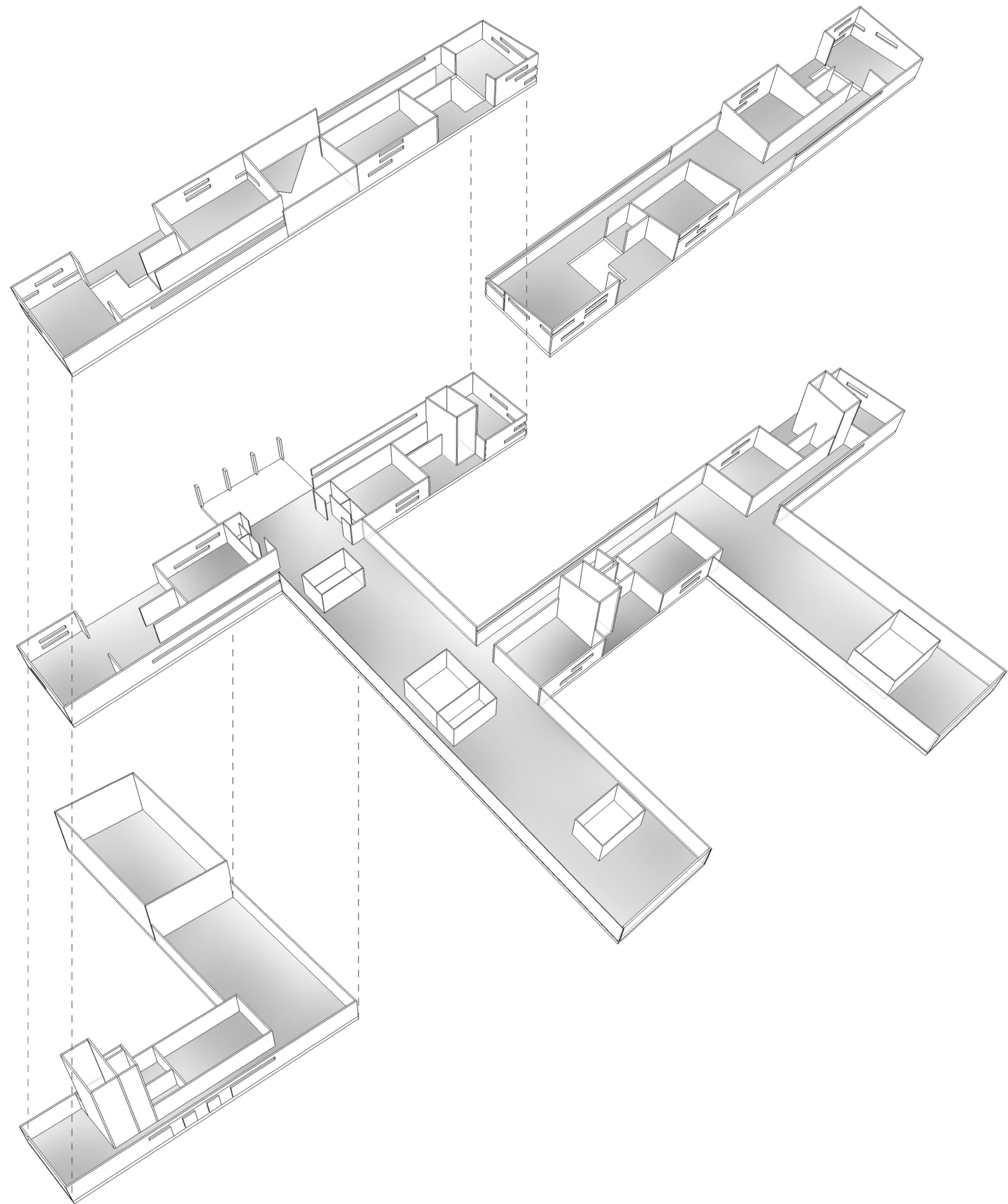

Aligning with the theme of flexible, adaptable spaces, the classrooms have the ability to be opened up to include the space of the hallway; expanding the learning environment and allowing for communication between classes. Younger learners are accommodated on the ground floor with direct access out into the landscape. An external balcony provides outdoor teaching spaces to the upper classrooms for older learners and provides cover to the spaces below.

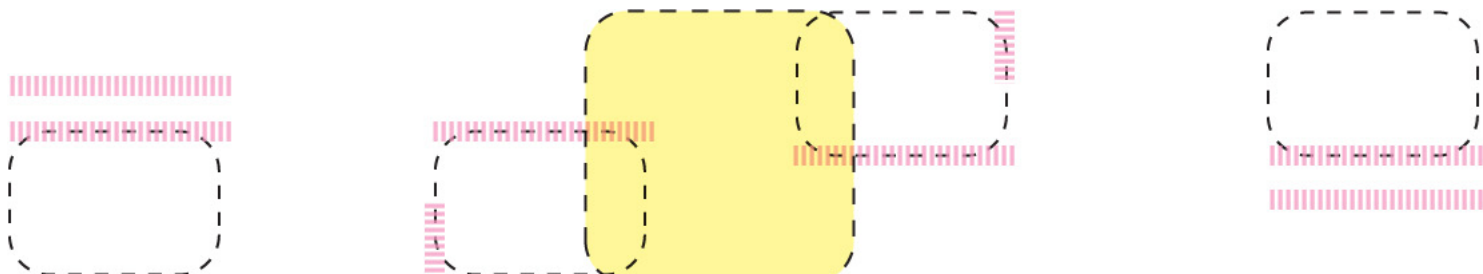
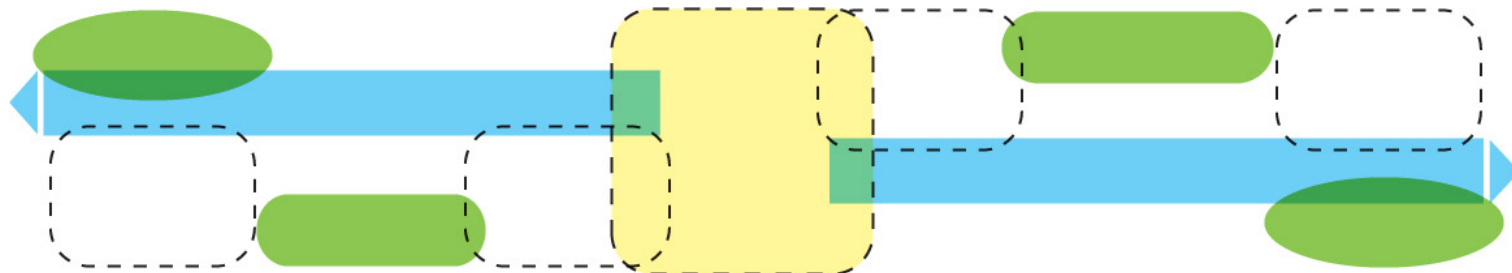
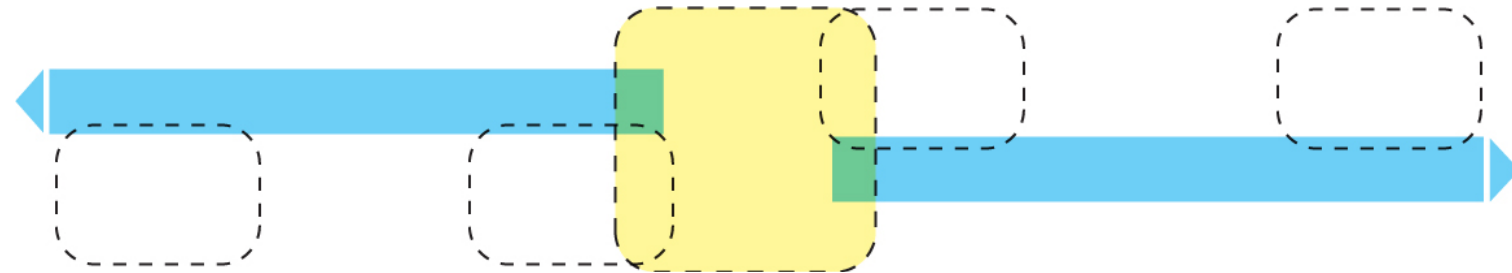
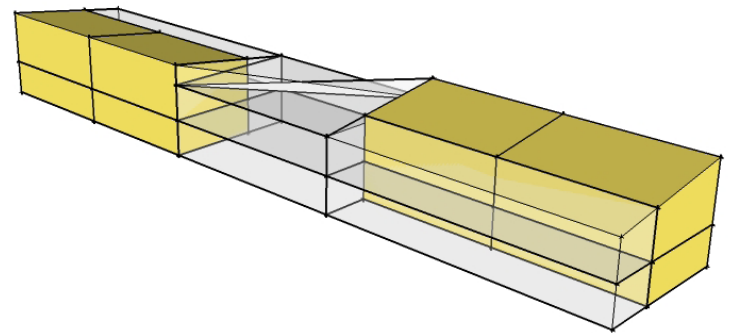
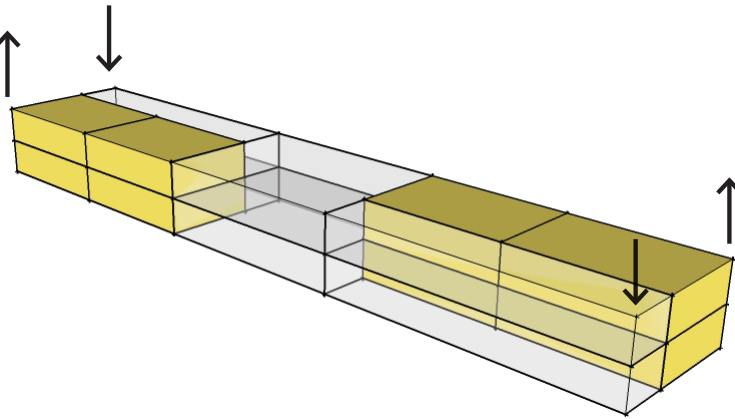
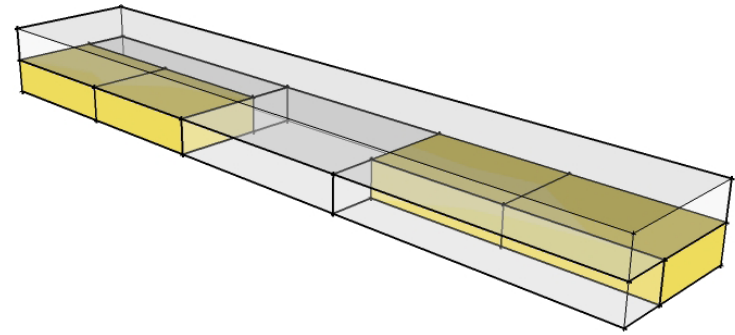

arrange

classrooms are arranged on alternate sides of the hallway within each bar

transform

the hallways are an extension of the classroom

engage

each learning space engages an adjacent outdoor learning area

permeate

sliding panels make it fast and easy to open up the classrooms to the activity filled hallway and outdoor learning spaces

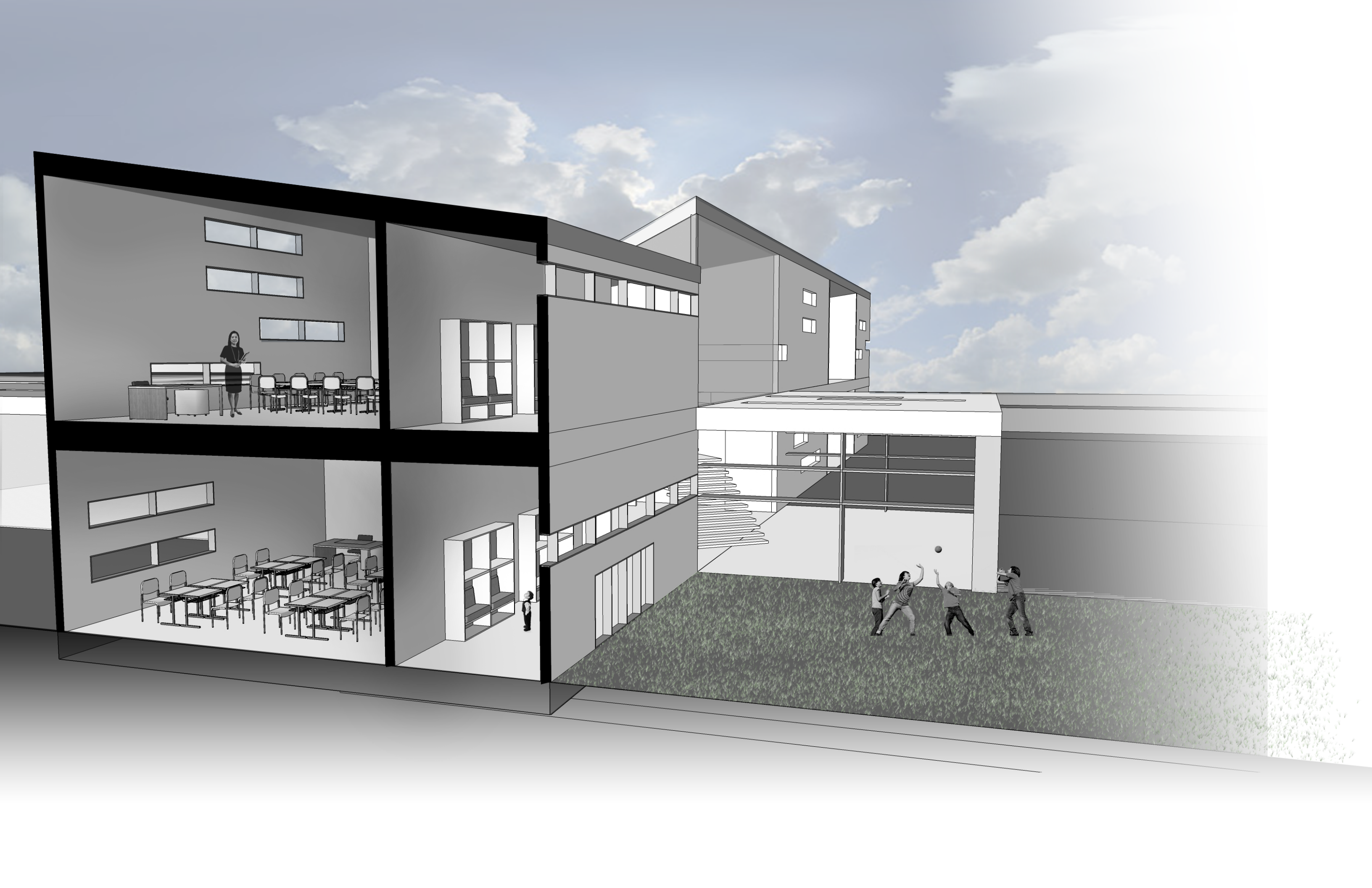

The school is built with cross laminated timber construction. This technique is new to North American markets but many examples can be found abroad, namely in the UK. Cross laminated timber is made by laminating dimensional lumber at right angles, similar to plywood. The result is a material that is strong, fire resistant and ecologically responsible in that the building will continue to sequester carbon dioxide during its lifetime. The exterior panels are made of a high-density stratified timber, and the resulting effect is a warm, inviting environment for the students and the community.

CROSS LAMINATED TIMBER is made by laminating dimensional lumber at right angles, similar to plywood. The result is a material that is dimensionally stable, capable of spanning large distances, reduces construction waste, increases airtightness and can be rapidly erected. The panels can be used for all assemblies; floors, walls and roofs. Using a massive wood structure — from a carbon cycle perspective — not only produces far lower emissions during the manufacture of the material, but the wood also sequesters carbon for its life span.

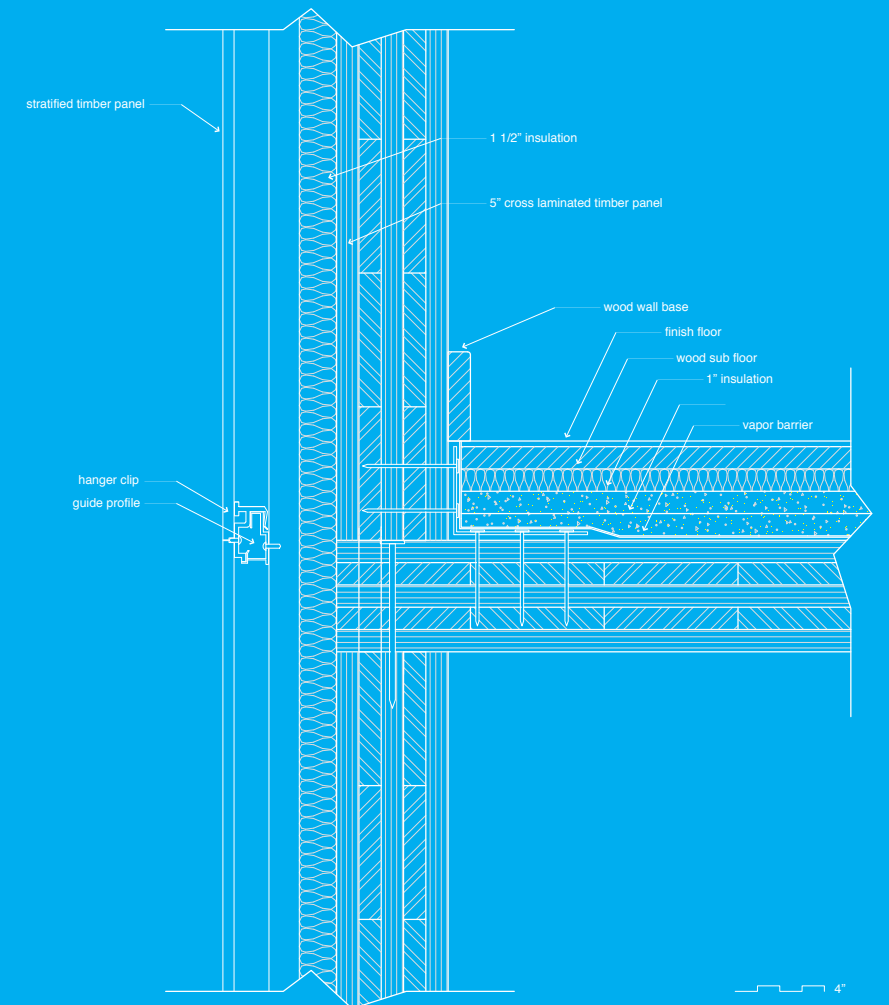
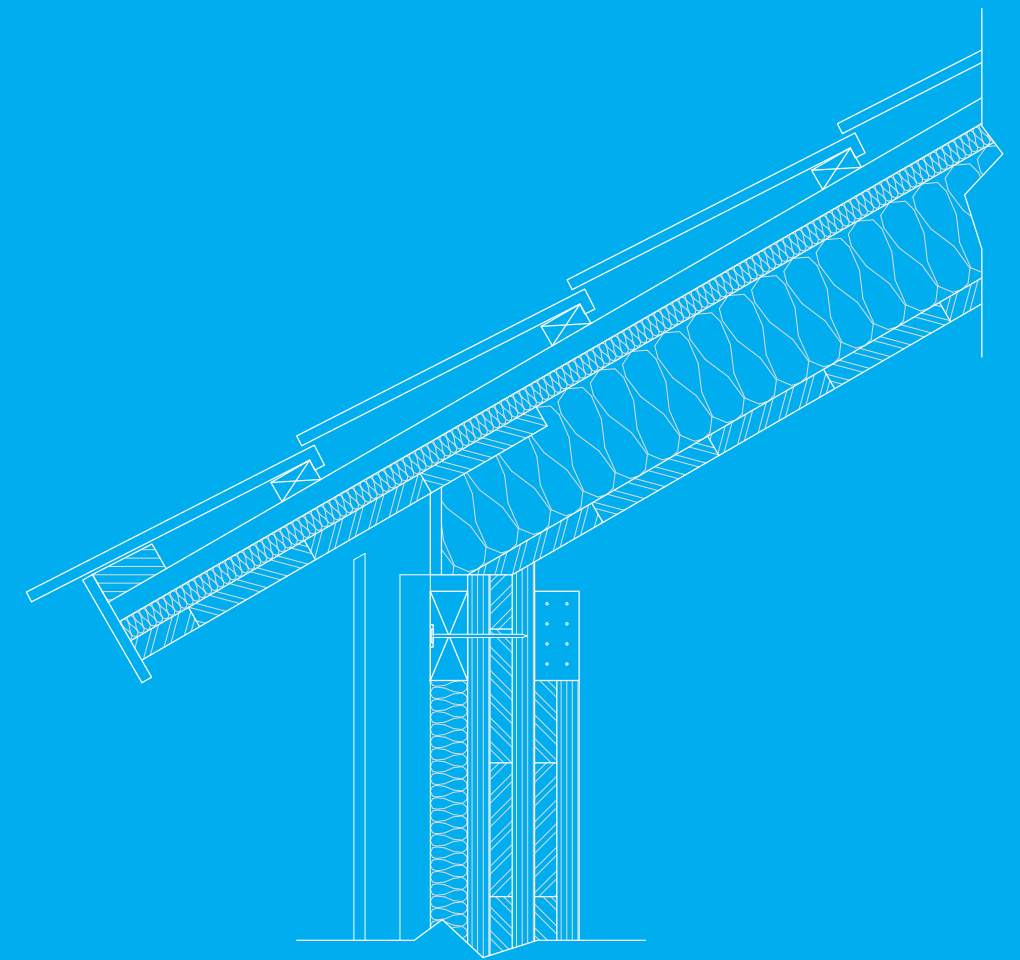
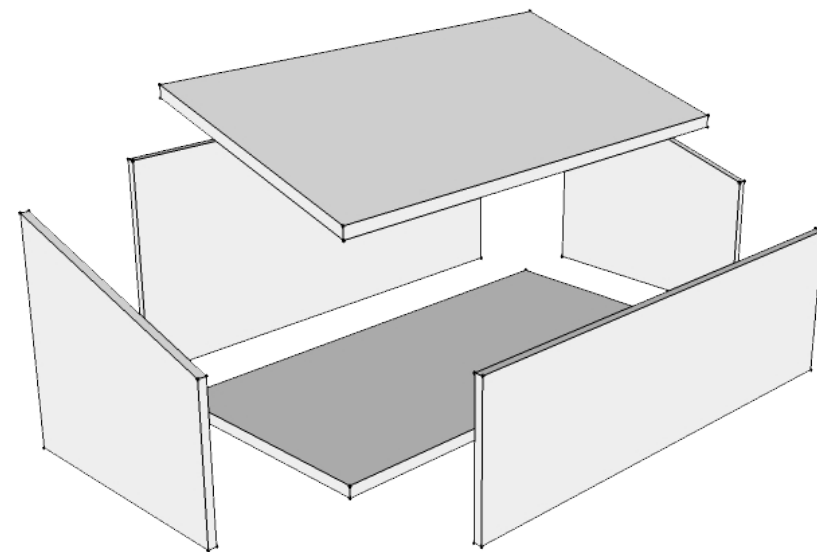

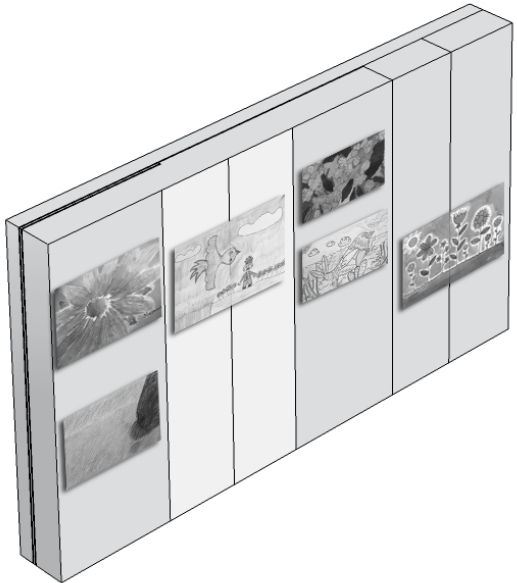
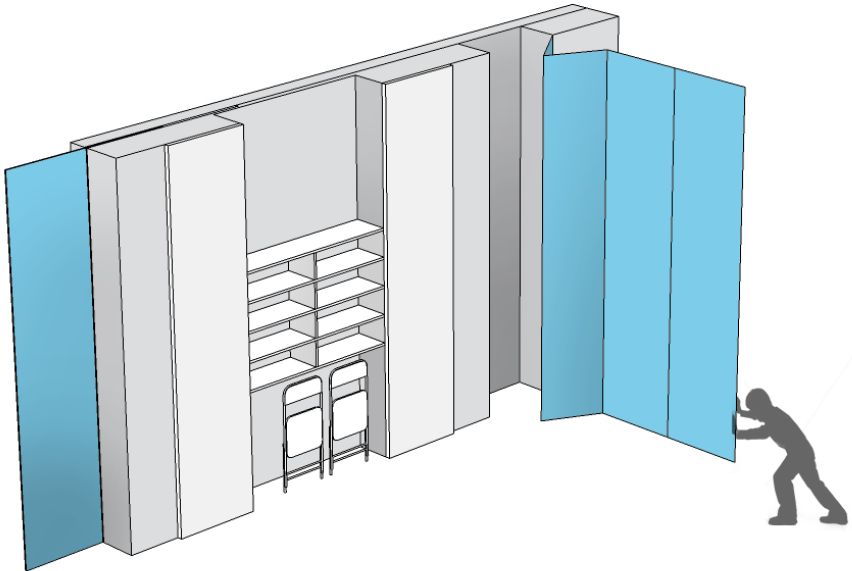
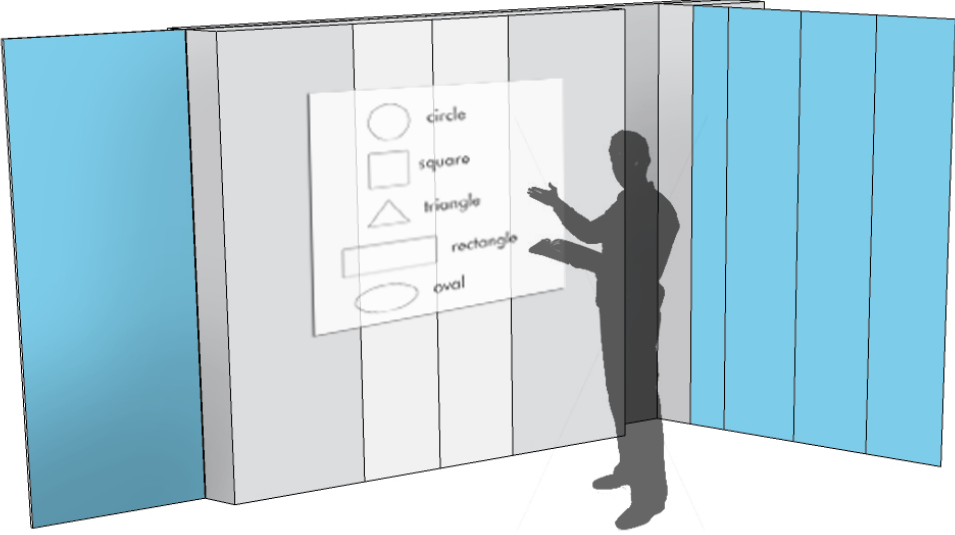

TEACHING WALL

- integrated technology
- tackable panels
- smart boards
- hidden storage space
- movable divider wall

the design process

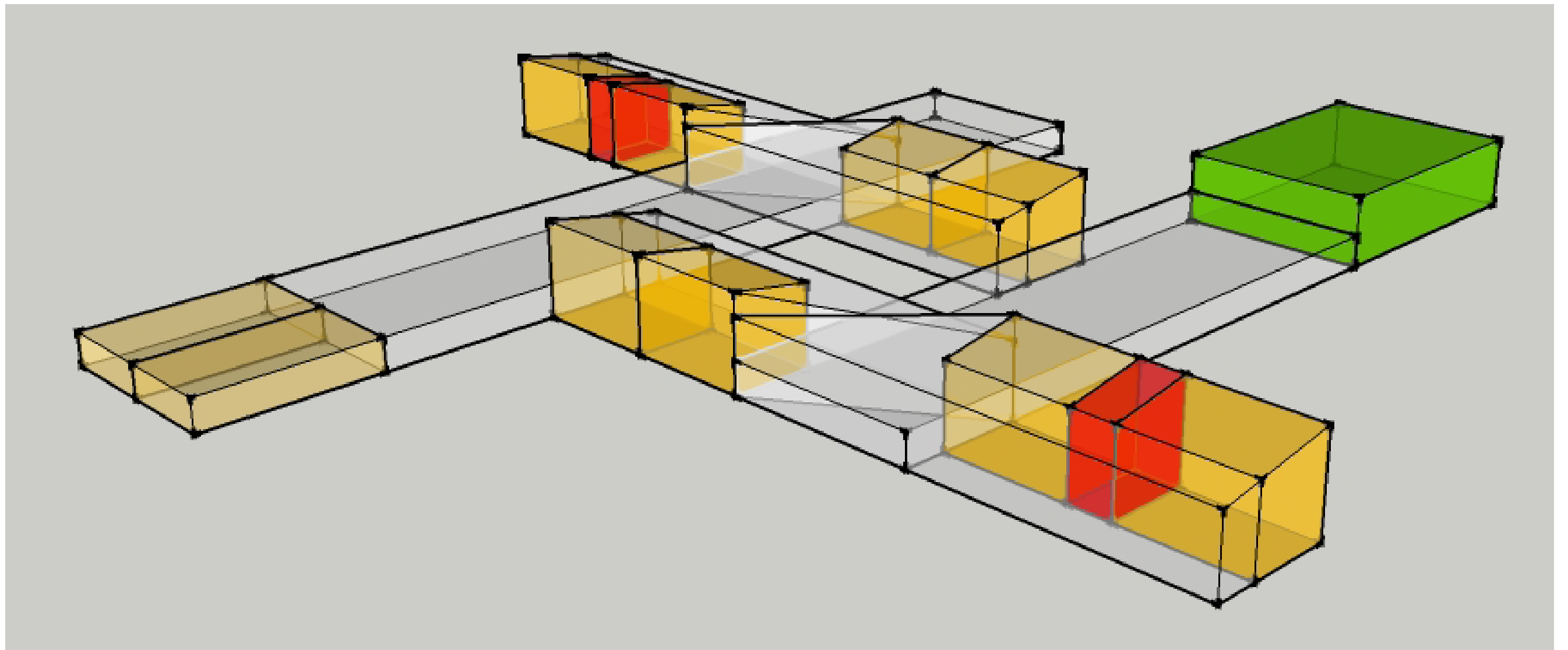
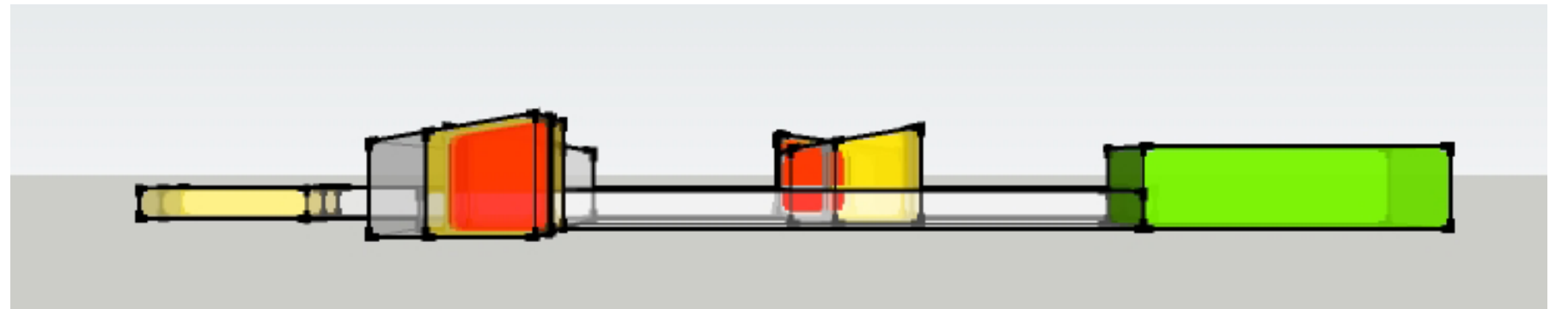
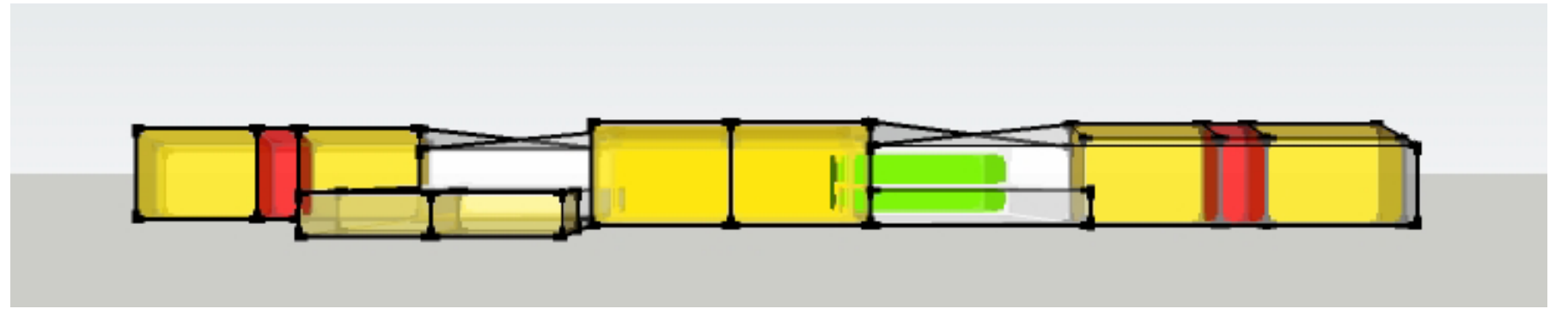
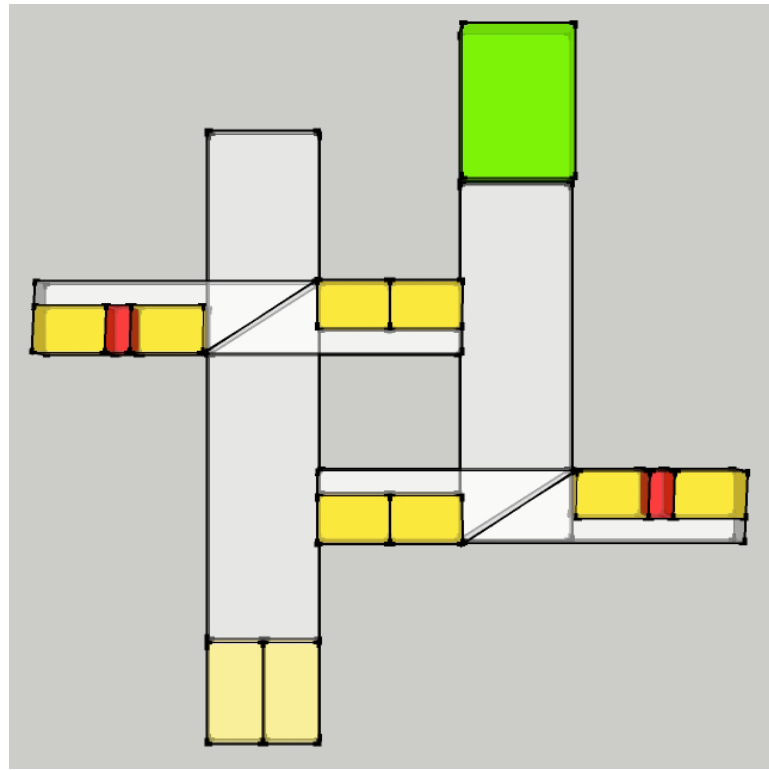

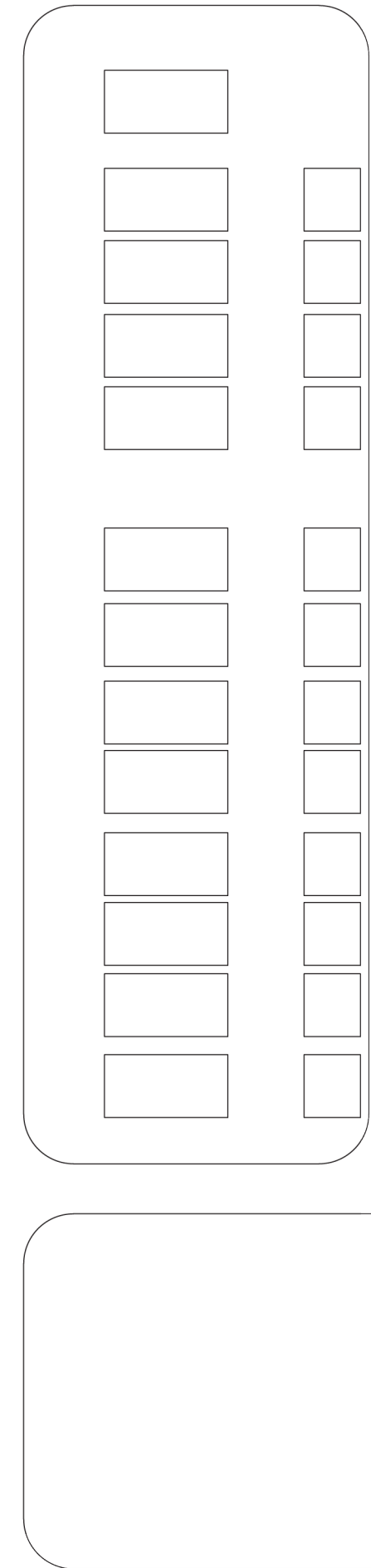
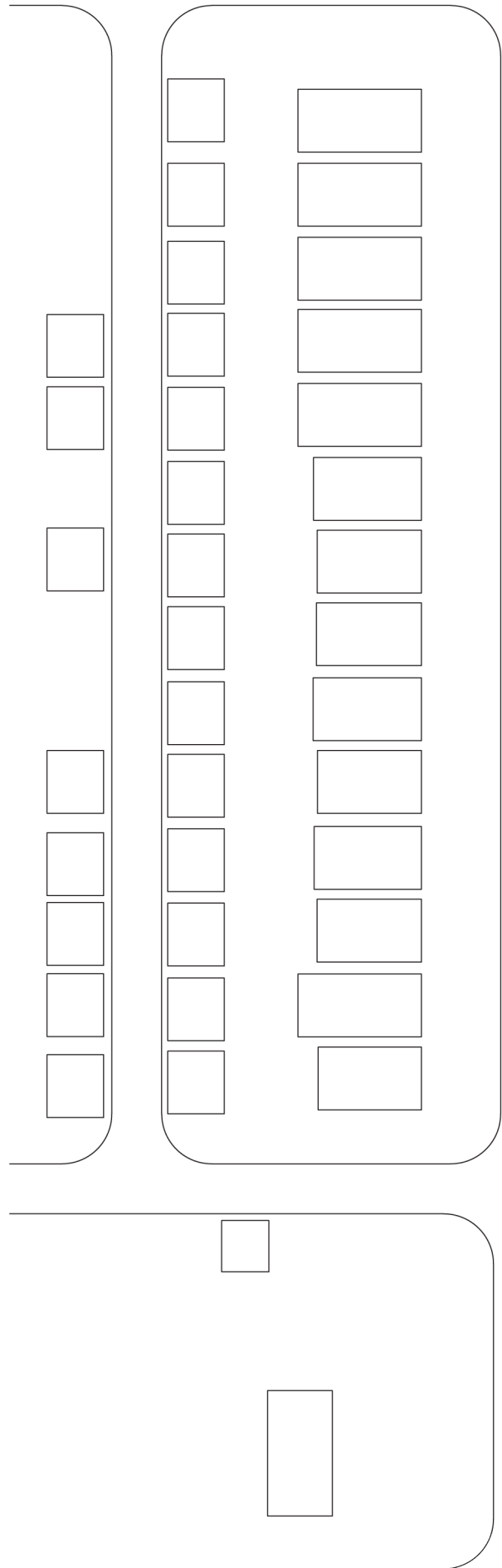

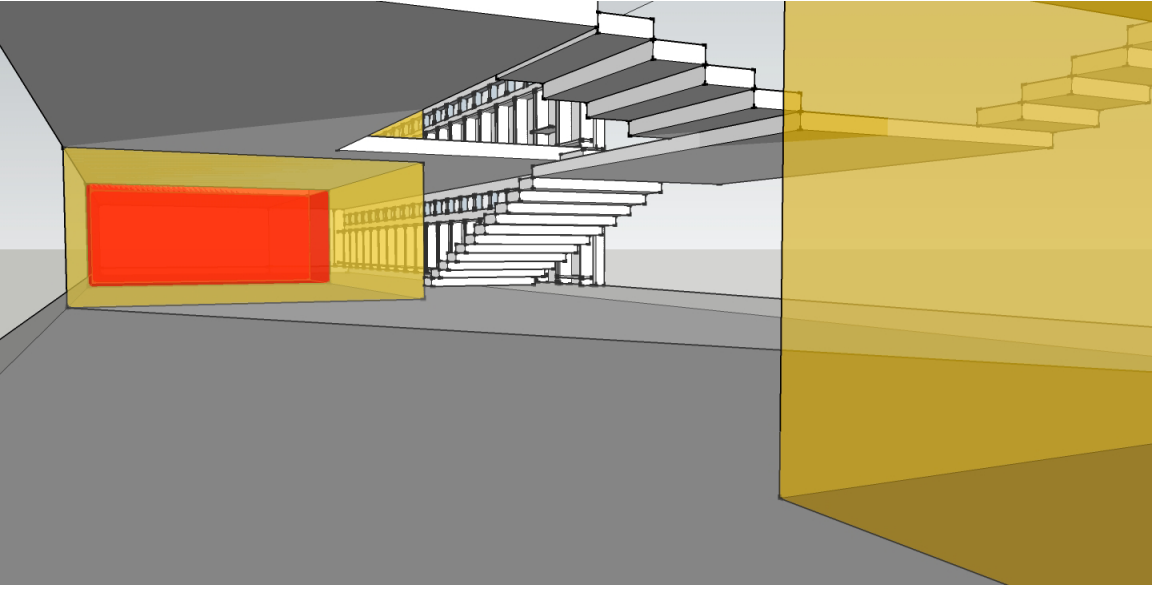
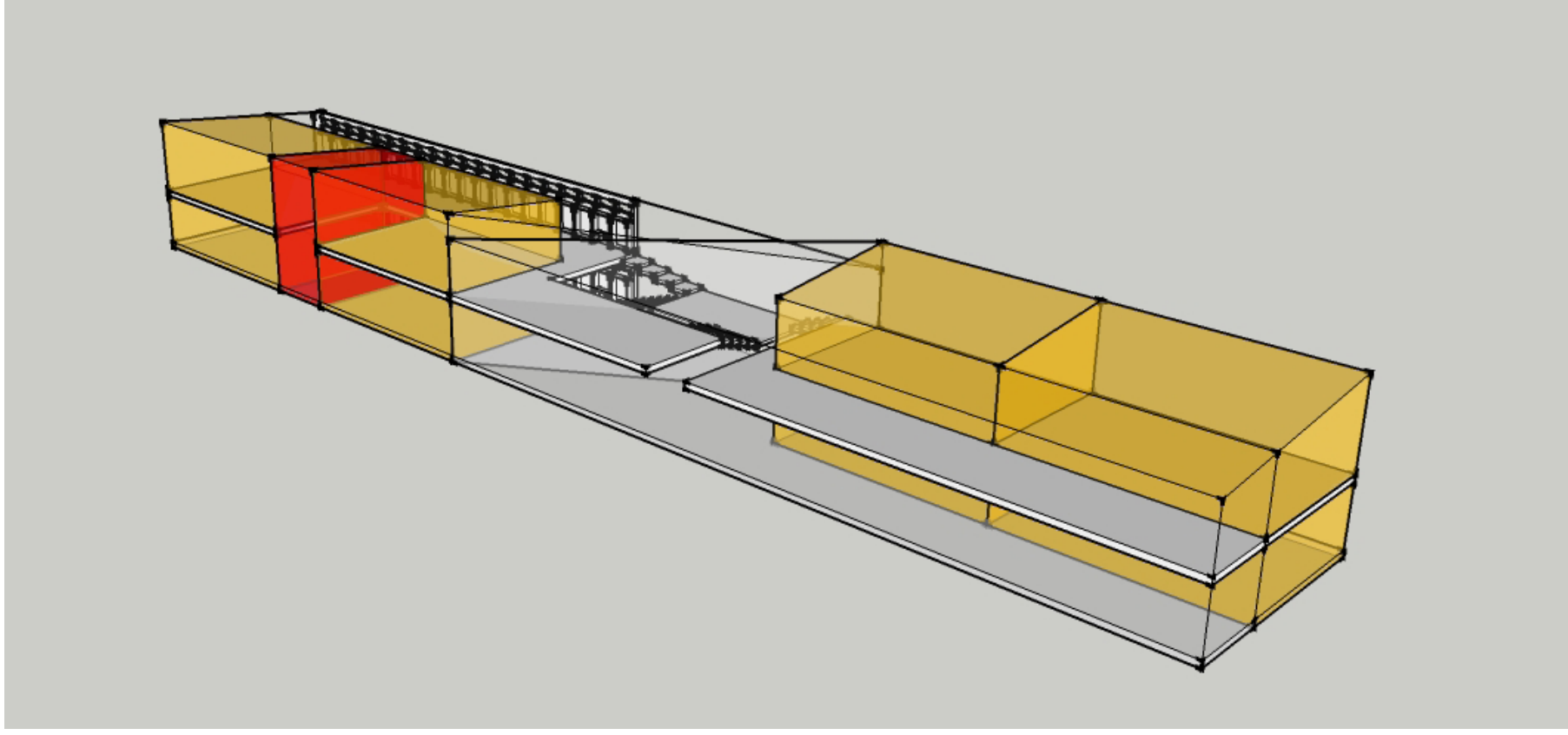
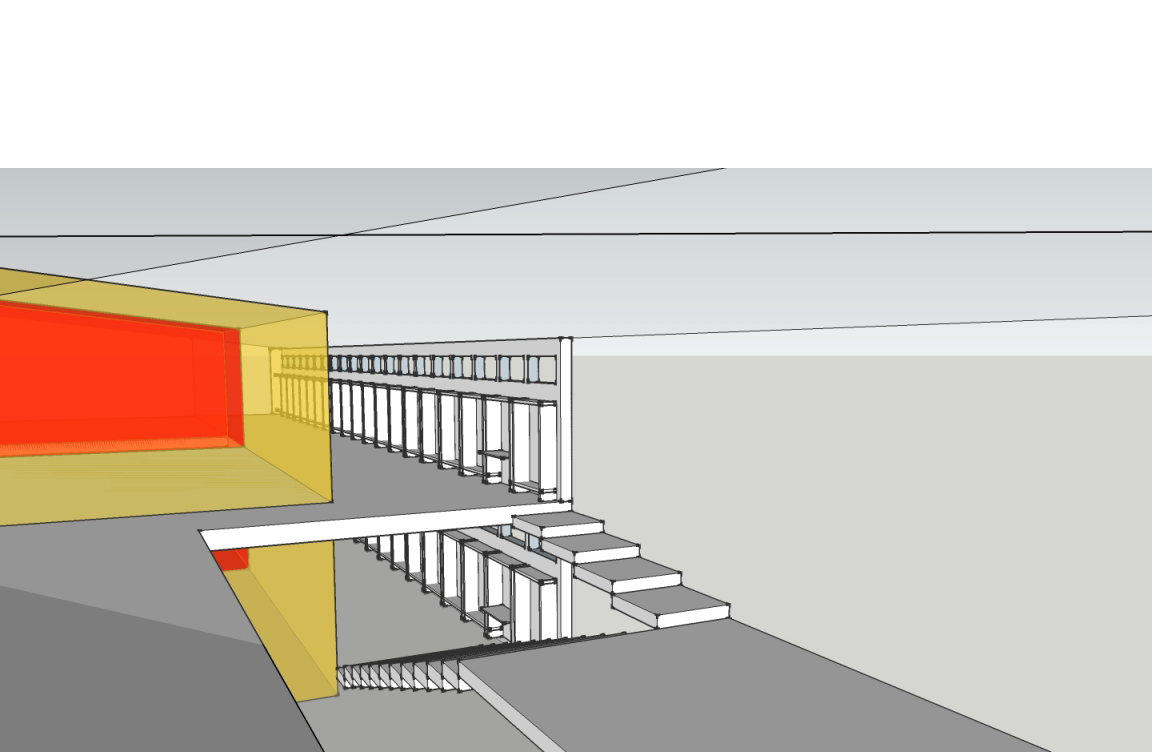
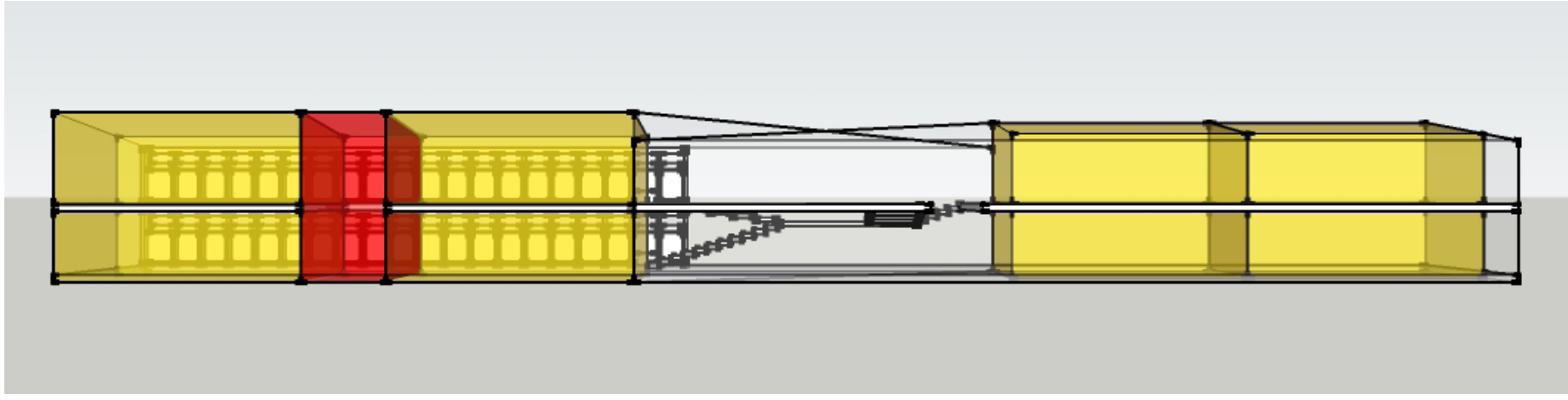
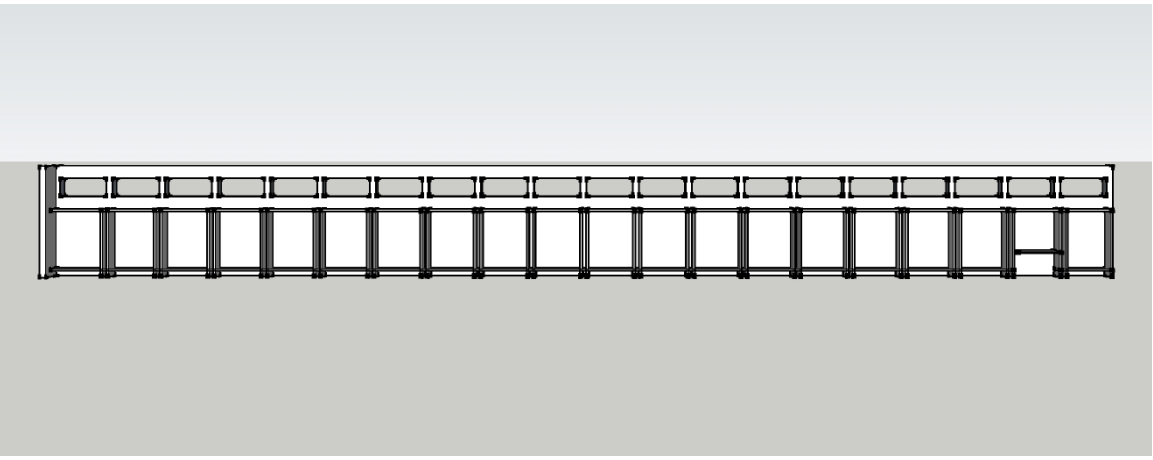
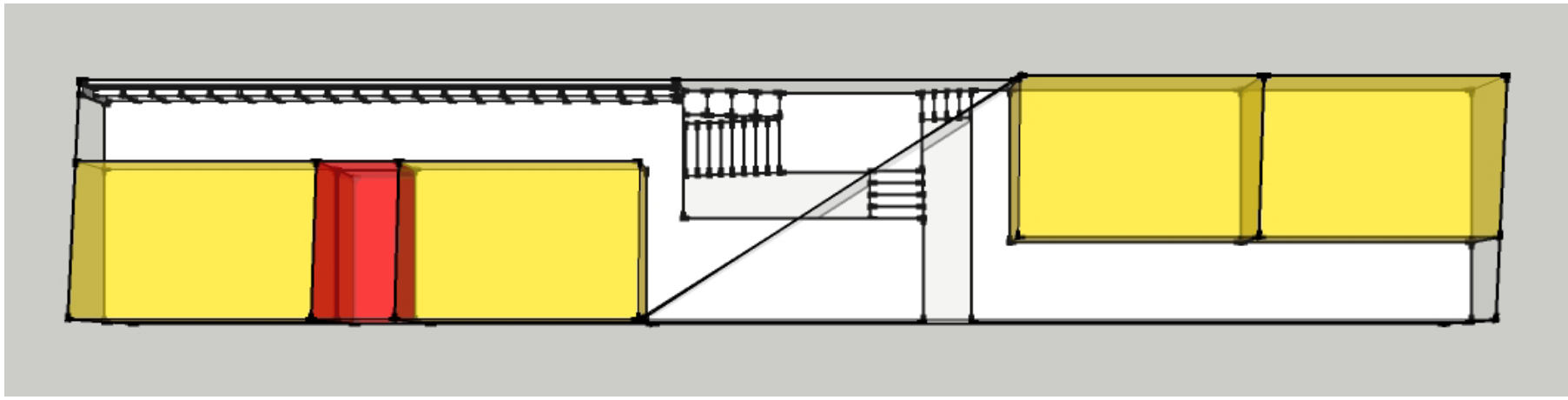

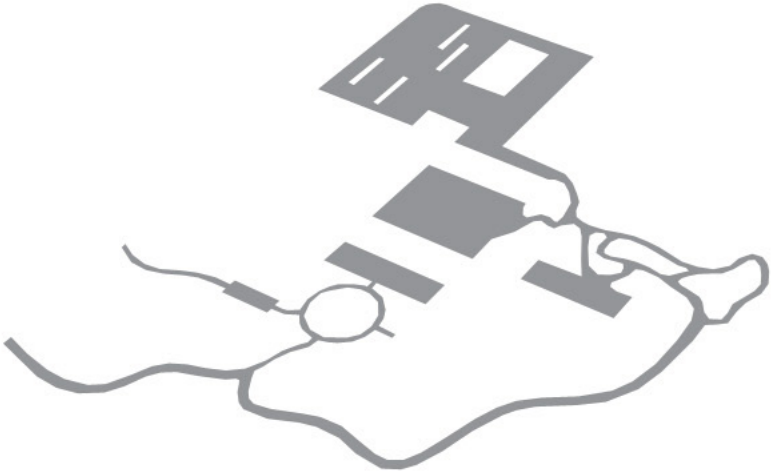

pathway

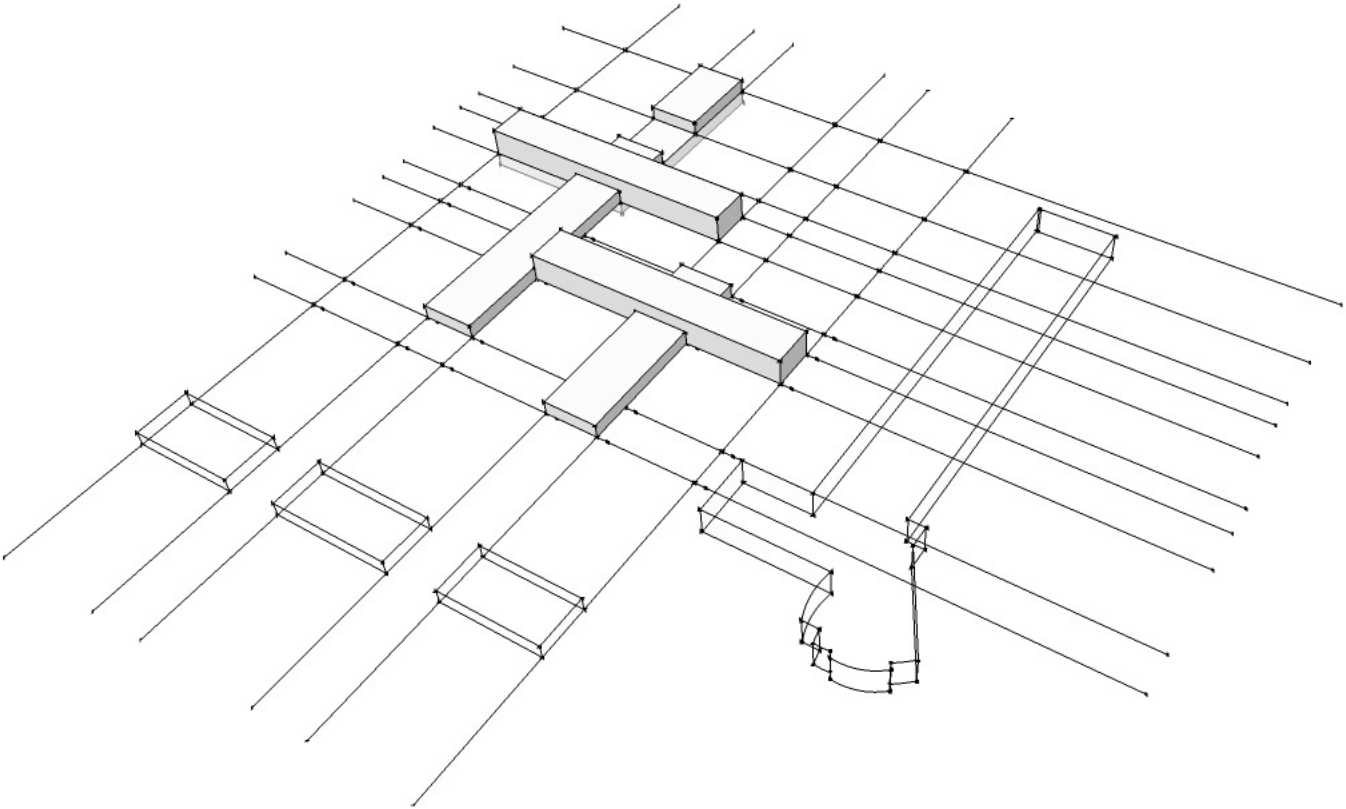

projection

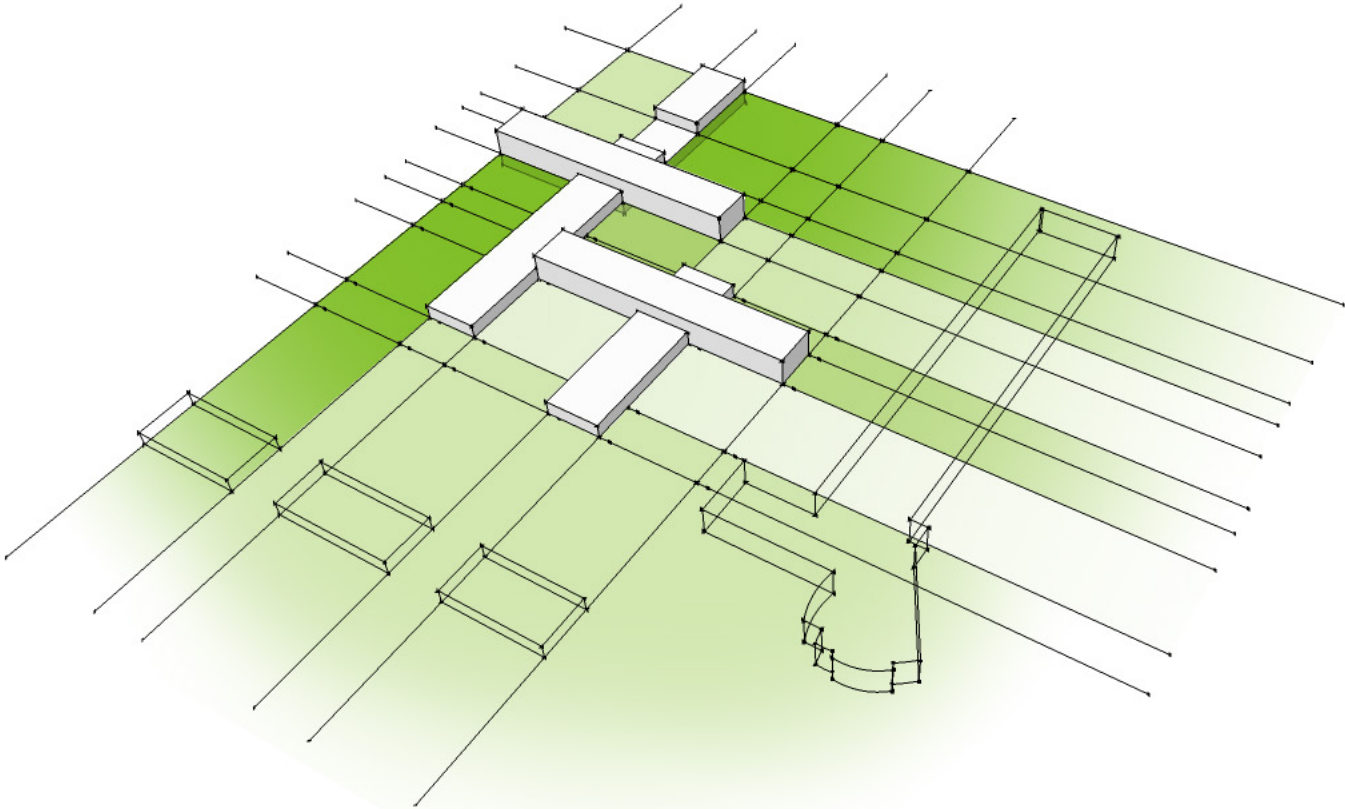

patchwork

teaching gardens
community gardens



*Patio Garden Cirqada
Delta Vorm Groep*

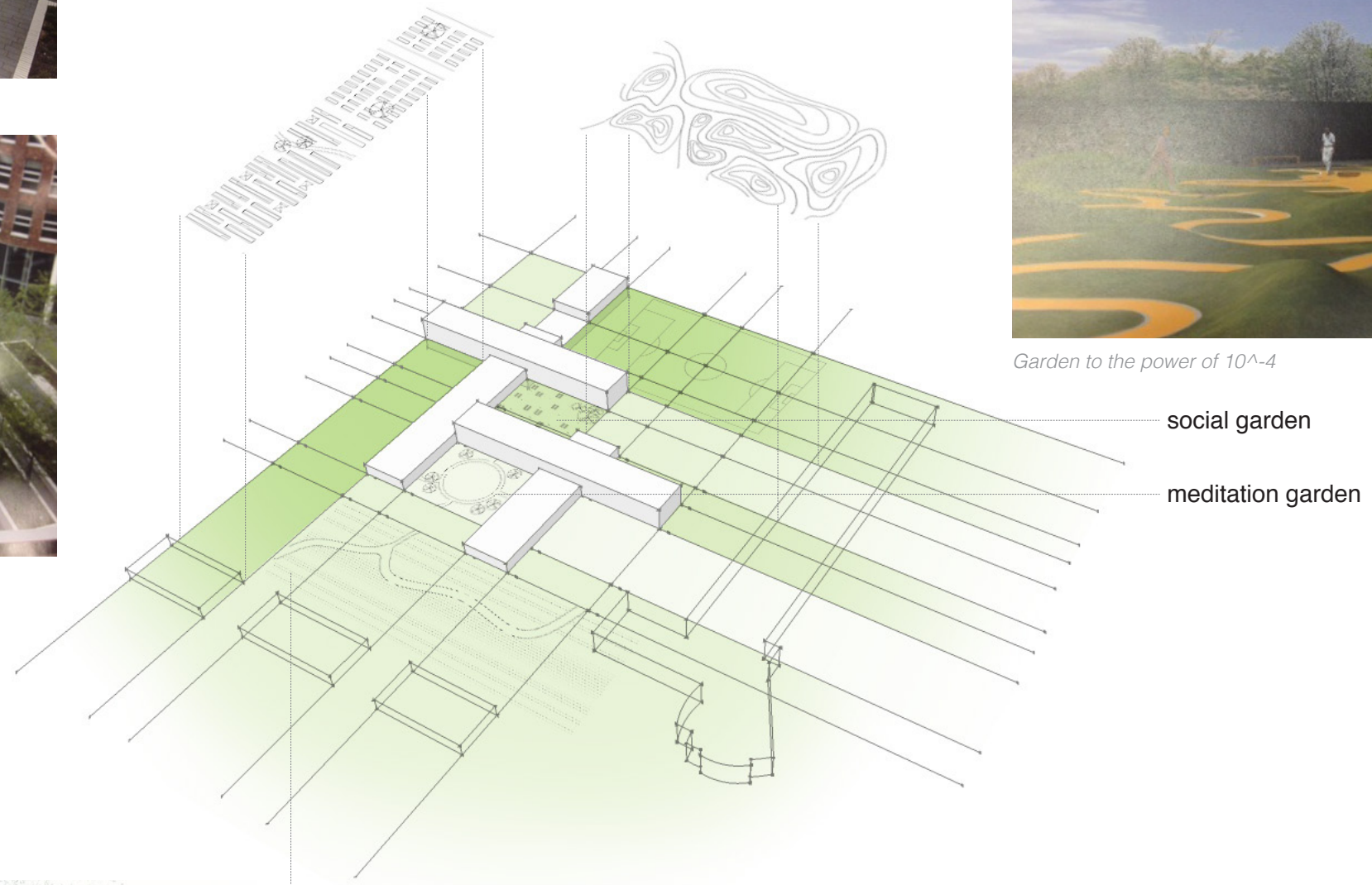

hilled landscape
views to playing field



Garden to the power of 10⁻⁴

social garden

meditation garden



native prairie grasses
tactile experience

*Shenyang Jianzhu University Campus
Turenscape*

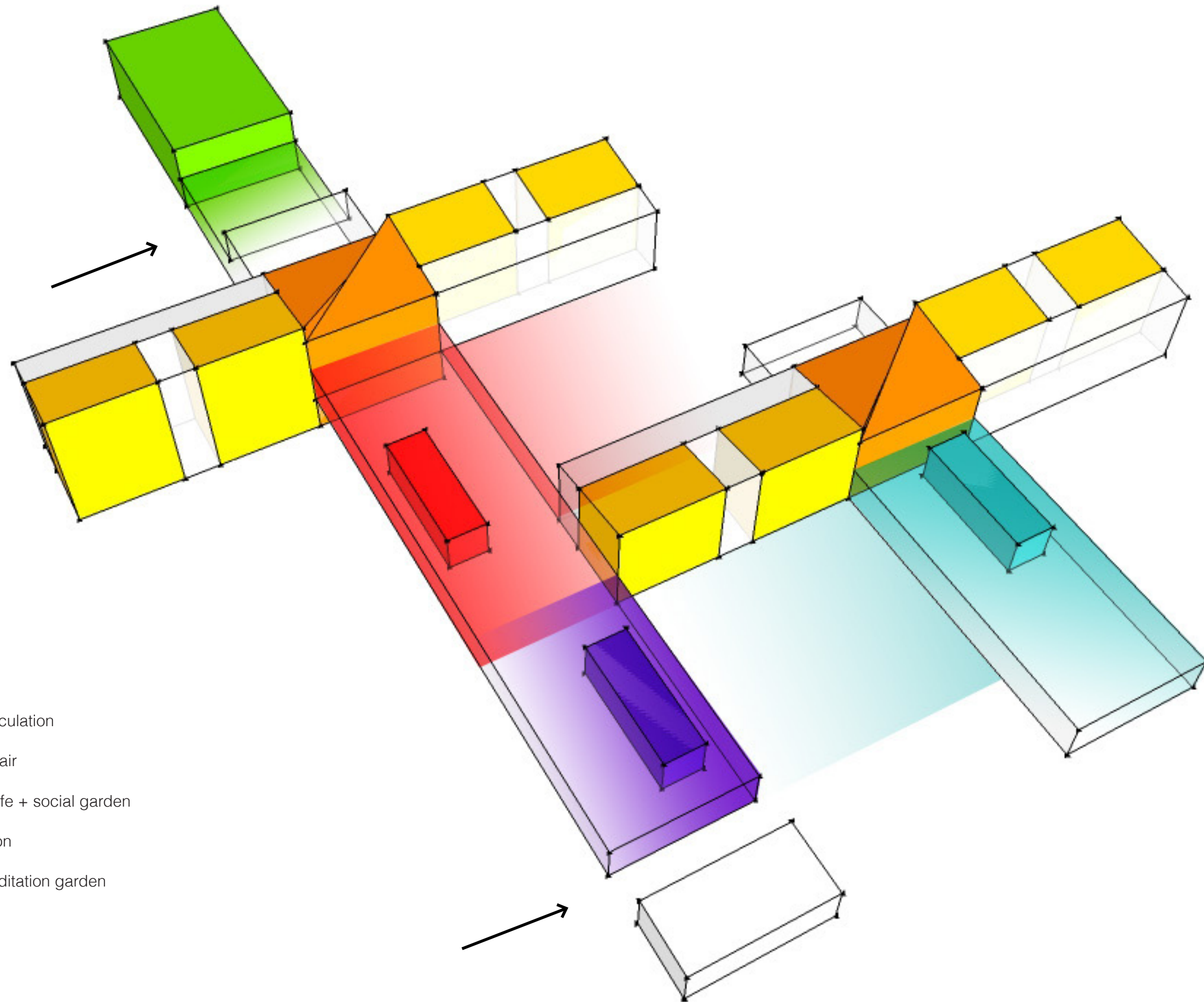

- gymnasium
- classroom
- activity + circulation
- corridor + stair
- kitchen + cafe + social garden
- administration
- library + meditation garden

