

Hybrid Lego Bus Model

Hybrid Lego Bus Model Demonstrates

The Lego bus model was built to demonstrate these hybrid concepts:

- **Regenerative Braking:** The idea of a hybrid is to charge the battery using the electrical motor as a generator when braking.
- **Planetary Gears:** Planetary gears are one of the innovative systems available to enable the electrical motor and the ICE to work individually or in tandem, for the most efficient way to power the vehicle.
- **Visual Demonstration of Mechanical Concepts:** Overall the Lego bus is a useful model which helps one to visualize the mechanical systems of a hybridized bus.



Support Frame

Objective:

- Determine a practical and effective design for the mechanical supporting structure for the hybrid test bed
- The structure must support all of the components under all modes of operation while preserving acceptable component alignment and minimizing system vibration

Solution:

- Rectangular shaped frame consisting of "C" and "I" sections that is similar to standard bus frame designs
- Stainless steel should be used to maintain the integrity of the frame

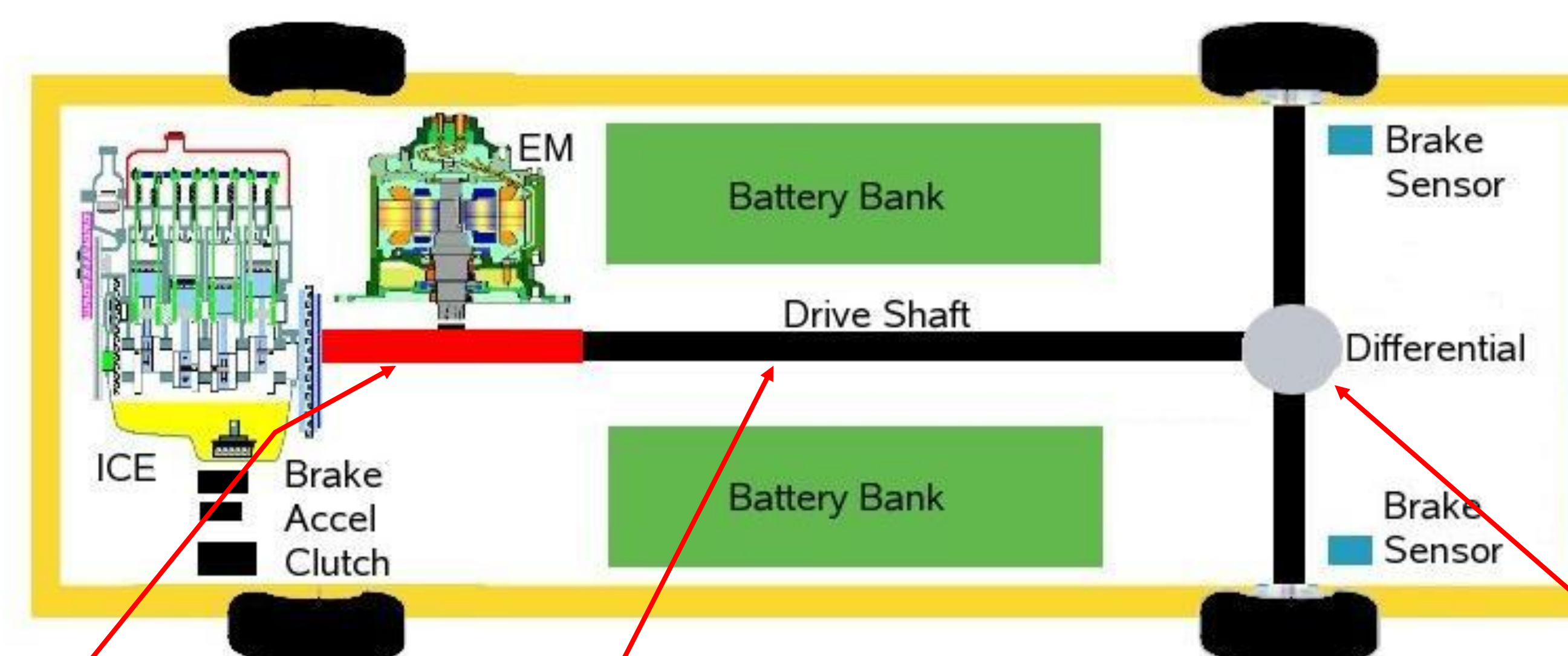
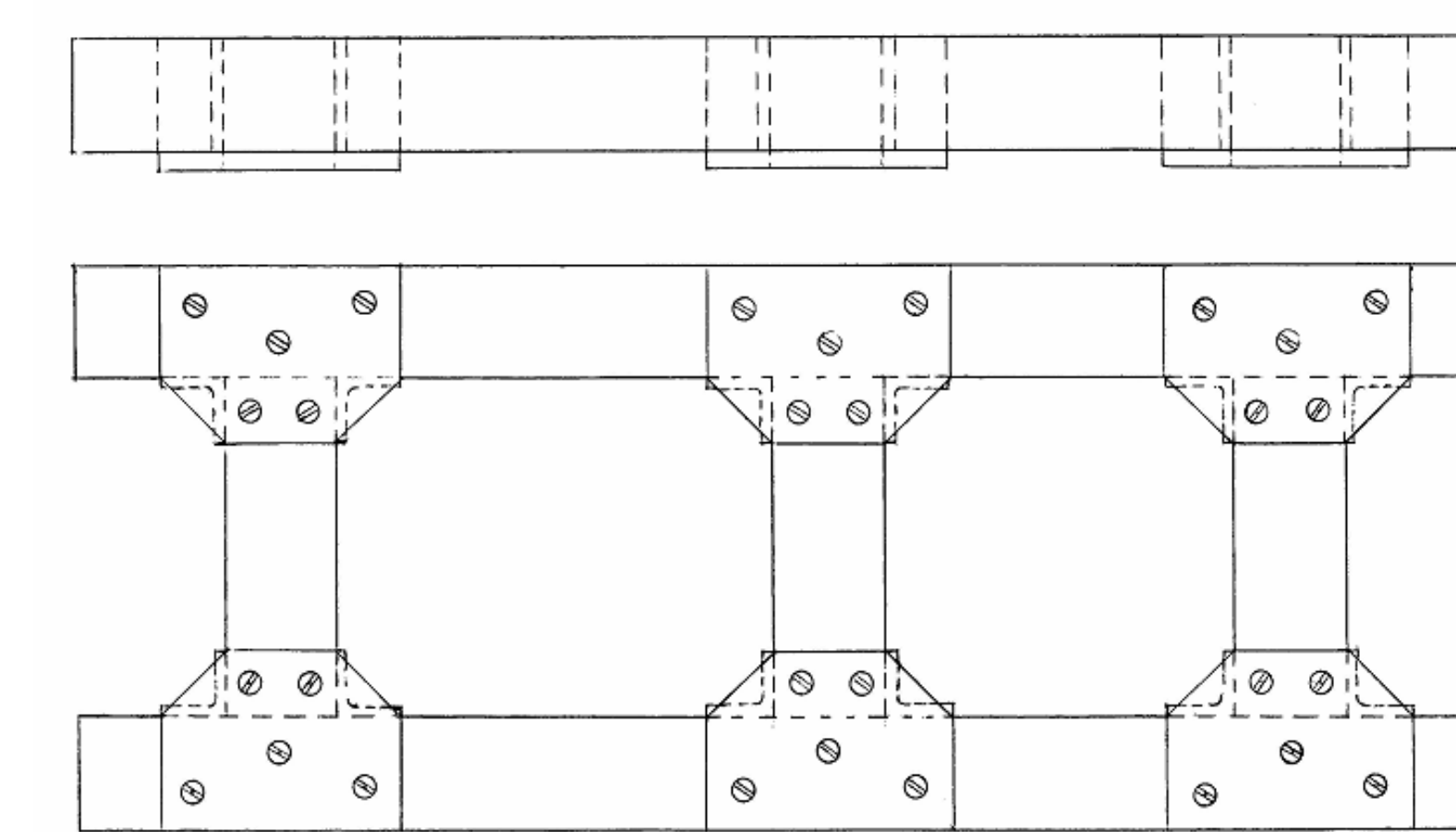

Drive Shaft

Objective:

- Find a suitable drive shaft that will transfer power efficiently from the ICE and the EM to the loads at the wheels

Solution:

- Use solid drive shafts along with universal joints and pillow block design
- 303 stainless steel type should be used to avoid corrosion

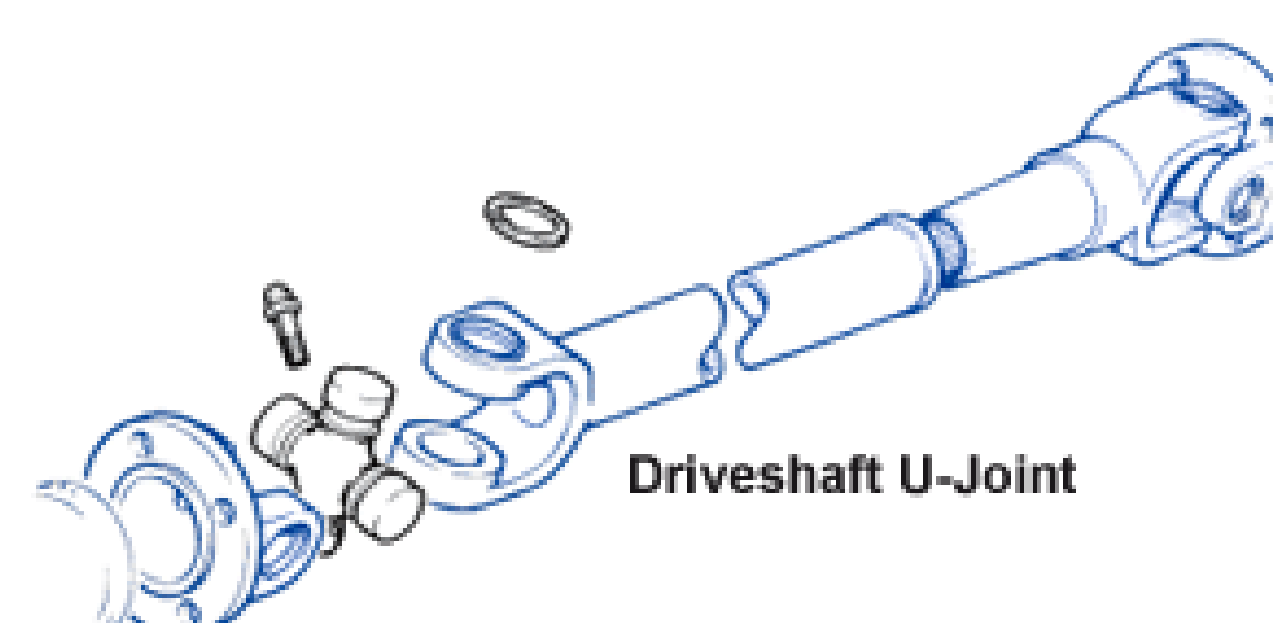
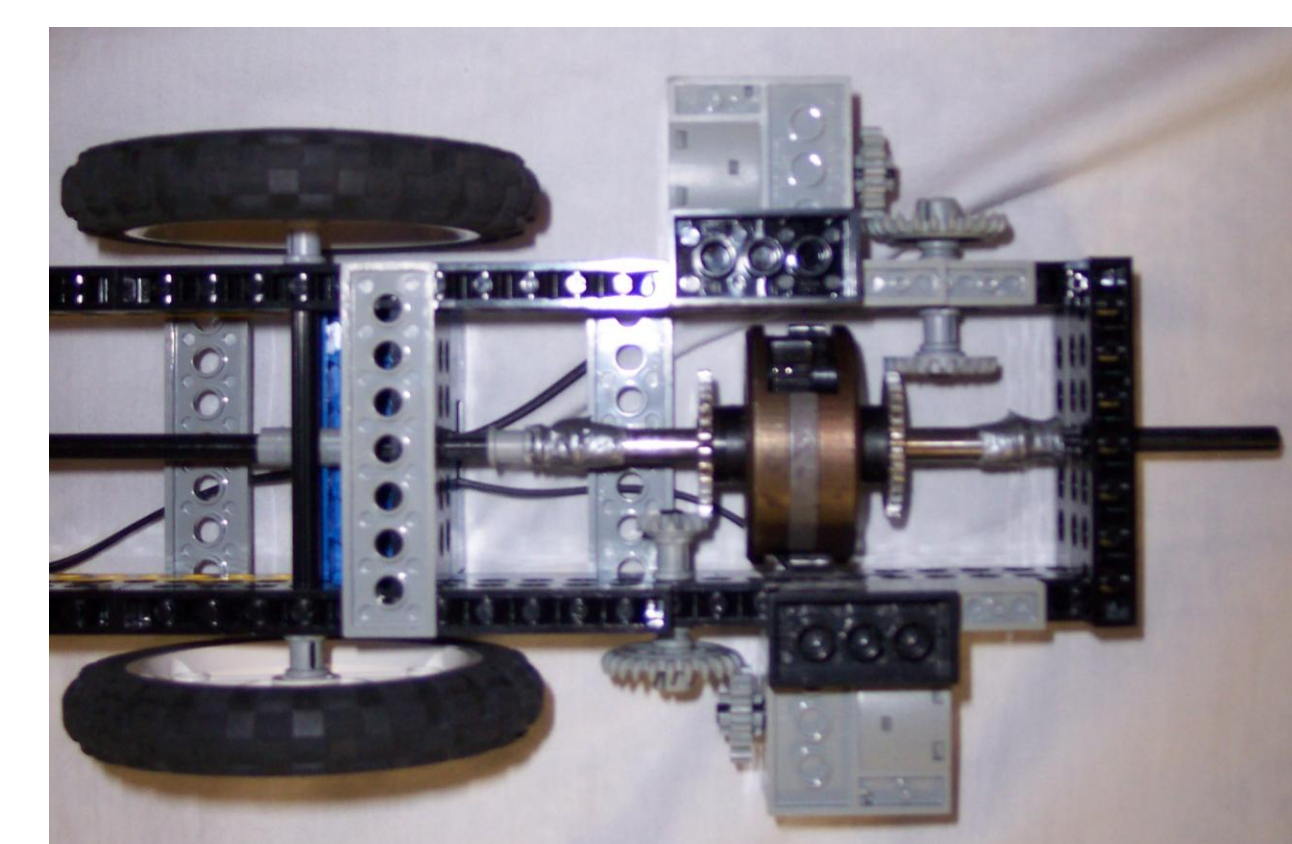

Picture courtesy of VictoriaBritish.com

Power Split

Objective:

- Select a power split or coupler that is able to efficiently combine power ratings for an electric machine (EM) and an internal combustion engine (ICE) in order to send the combined power to the drive shaft

Regenerative Braking:

- Allows the ICE to generate energy to charge the battery packs when braking occurs

Solution:

- Planetary gear box with the EM and ICE as inputs and the drive shaft as the output
- The EM acts as both the electric machine and also as a generator for regenerative braking

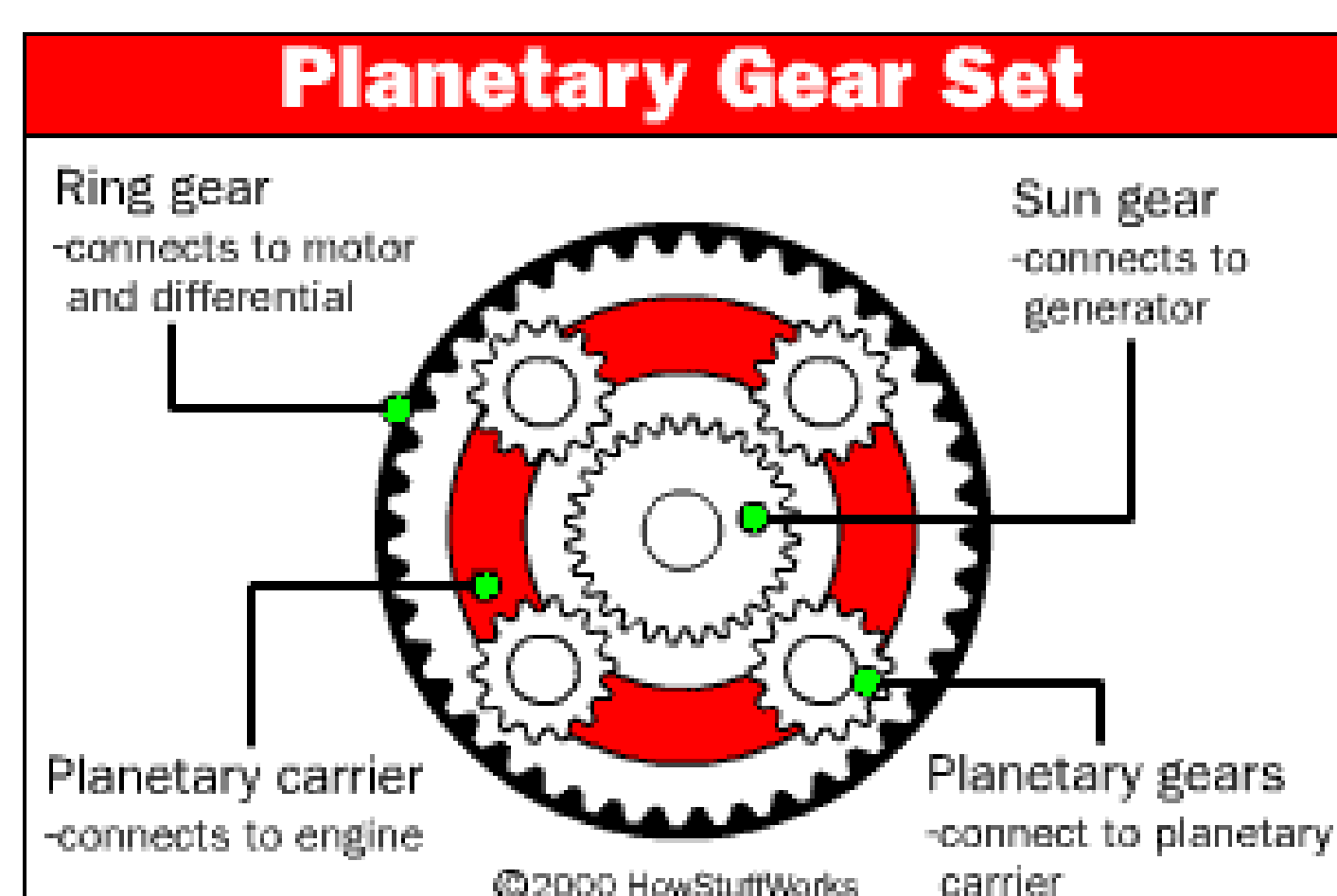

Picture courtesy of HowStuffWorks.com



Picture courtesy of Wikipedia.org

Differentials

Differential Gear Background Information:

- A simple open differential is a device which serves to supply power to the two wheels attached to it while allowing them to rotate at different speeds.

Various types of Differentials and their Feasibilities:

- There are several types of differentials available. These differentials are the Limited Slip Differential (LSD), the Locking Differential and another differential based on the components found in the ABS (Anti locking Braking System).

Solution:

- On the test bed the wheels will not experience any traction, this eliminates the need for the alternatives to the open differentials.

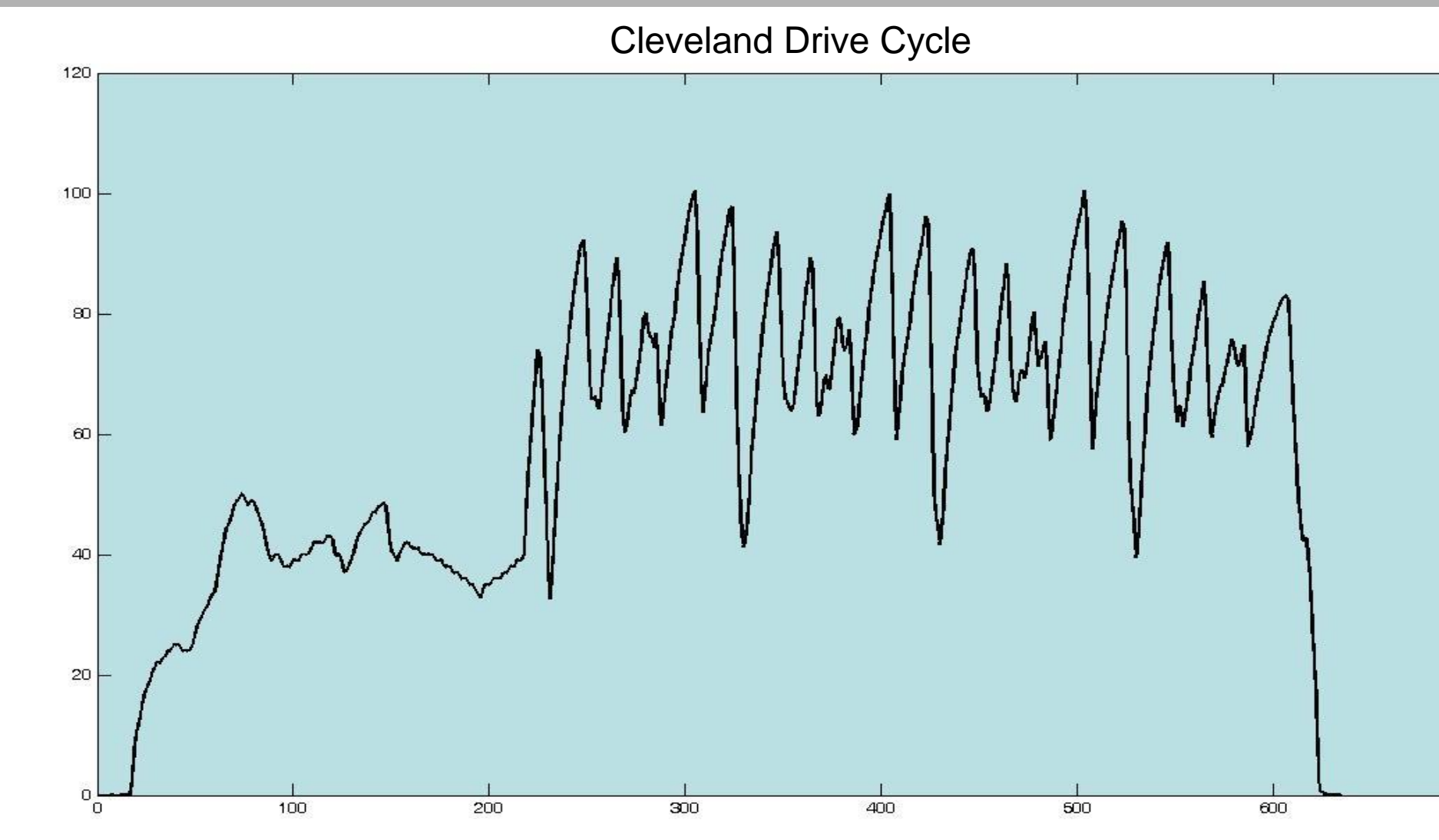
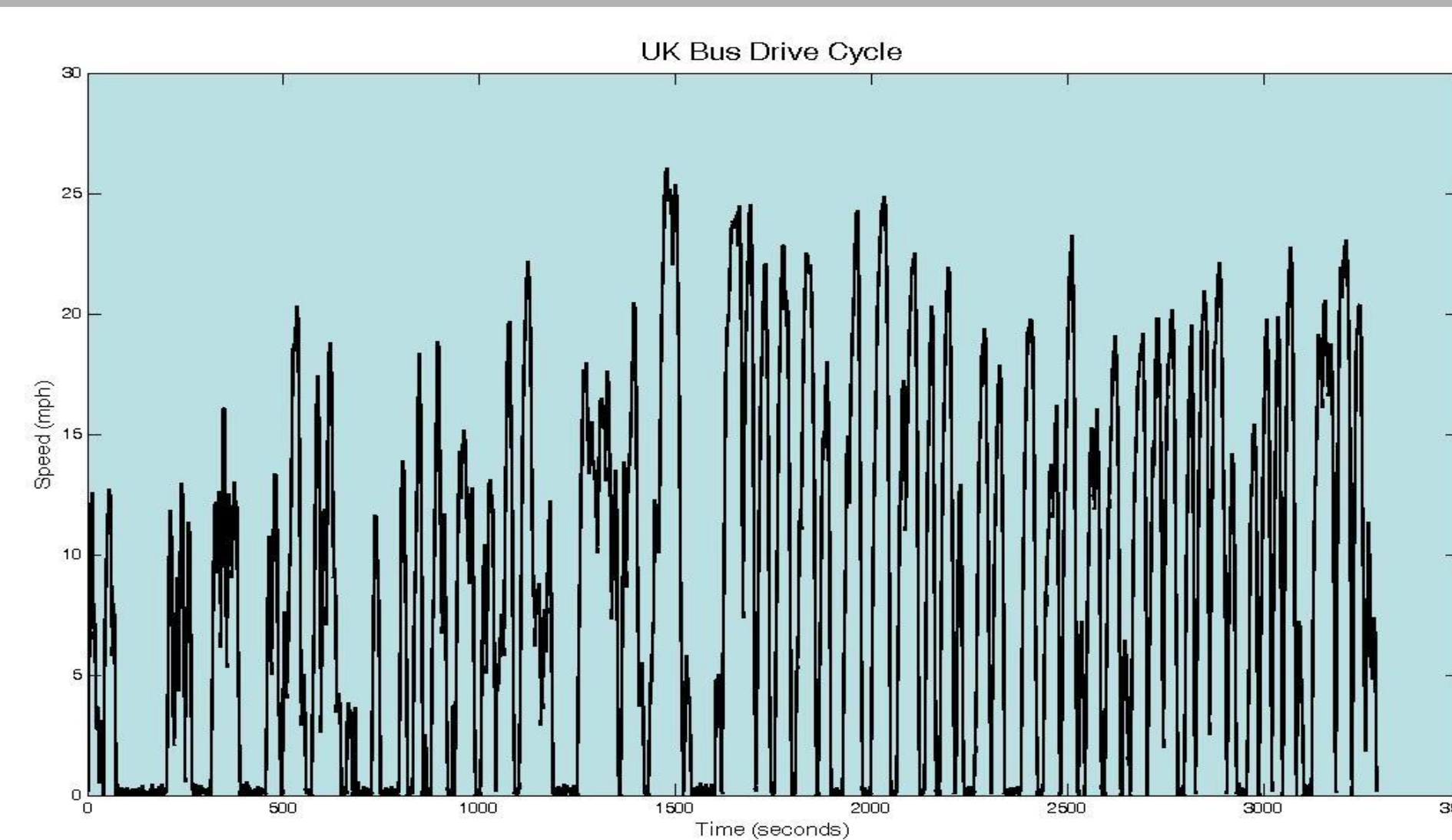
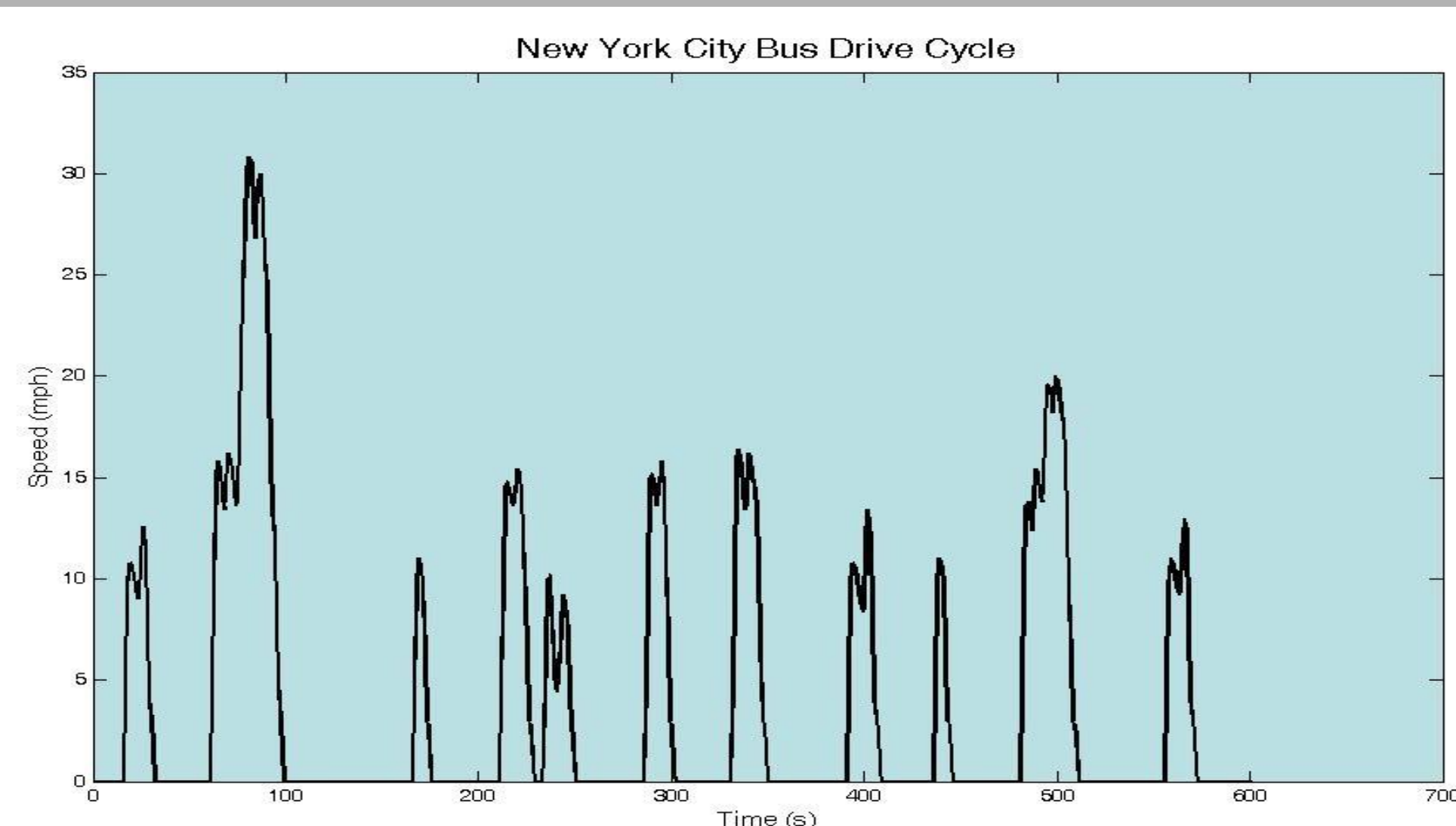

IPRO 342: Hybrid Electric School Bus Test Bed

HEV Test Bed

Hybrid cars are a newer option on the market, designed to increase the efficiency of vehicles. While there are already hybrid cars on the market with a standard design, there are limited ways to demonstrate the effectiveness of hybrids. A prime candidate for hybridization is a school bus, which frequently stops, carries children, and runs routes daily. Thus, this two semester IPRO has designed and will build a test bed that demonstrates why school busses should hybridize.



Contact: <http://www.iit.edu/~ipro342f06/>

Team Members:

Preeti Abraham (ME/4th)	Shan Colletti (EE/4th)
Joel Fenner (ME/4th)	Ali Gowani (EE/5th)
Eric Hope (EE/3rd)	Tyler Inouye (EE/3rd)
Mohammed Khader (CS/4th)	Jatan Shah (EE/3rd)
Aamer Saeed (ME/4th)	Garrett Nielson (EE/3rd)

Faculty Advisors:

Dr. Fernando Rodriguez
Dr. Ali Emadi

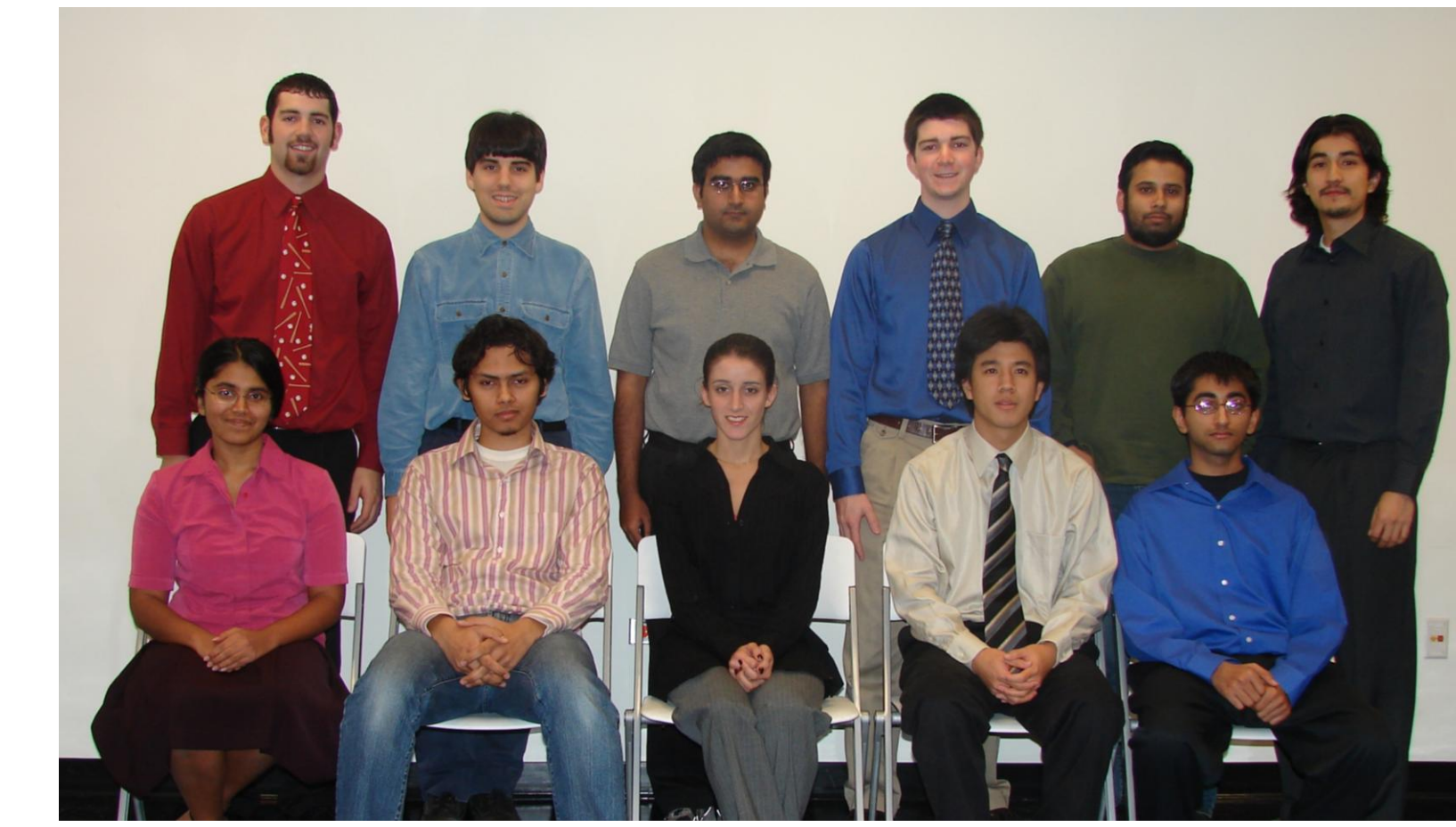

Hybrid RC Car

Introduction

An electrical motor running on a lithium ion battery was fitted on an ordinary (RC) car model. This model was used for testing hybridized acceleration. The RC car would first run on just the ICE and then with the electrical motor attached. The modifications involved the mounting of the electrical motor and the battery pack on the chassis of the traditional RC Car model.

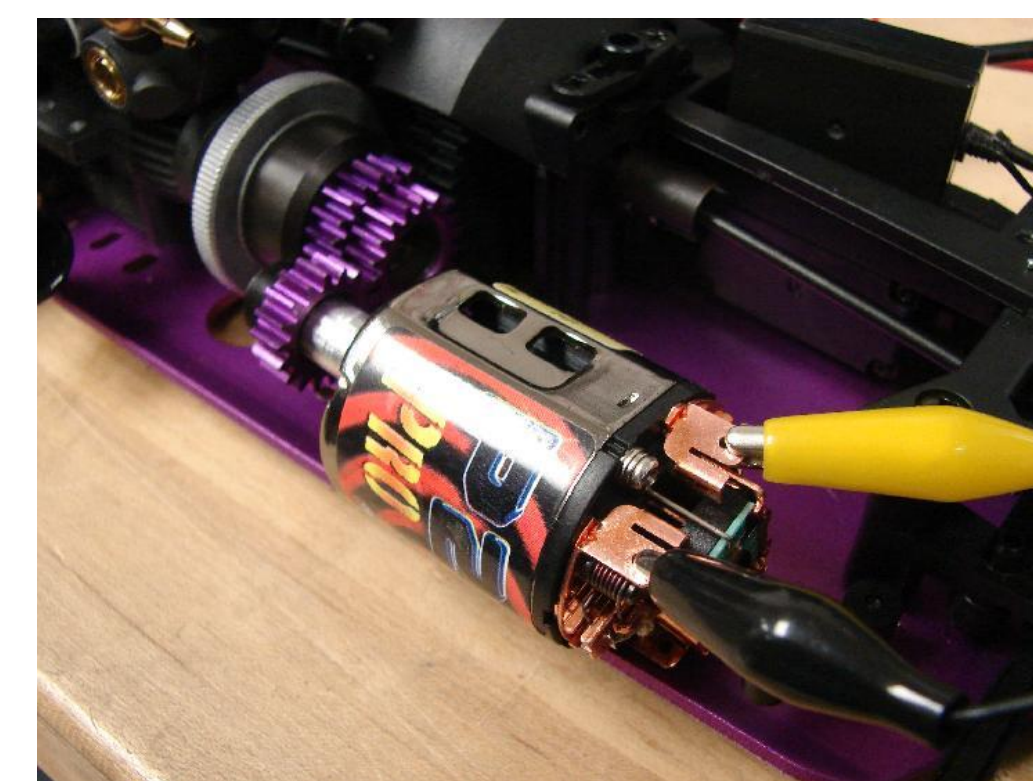

Performance

- Electric motors respond well to rapid changes in power, but tend to be less powerful than ICEs.
- Using both in combination, the availability of instantaneous power is improved, as is the total power available, improving performance.
- ICEs tend to have substantial "lag" associated with changes in power, but tend to be more powerful than motors.

Reasons to Hybridize

- The two most common mechanical drives, electric motors and internal combustion engines (ICEs), each have strengths and weaknesses.
- Depending on the circumstances, one is more desirable than the other.

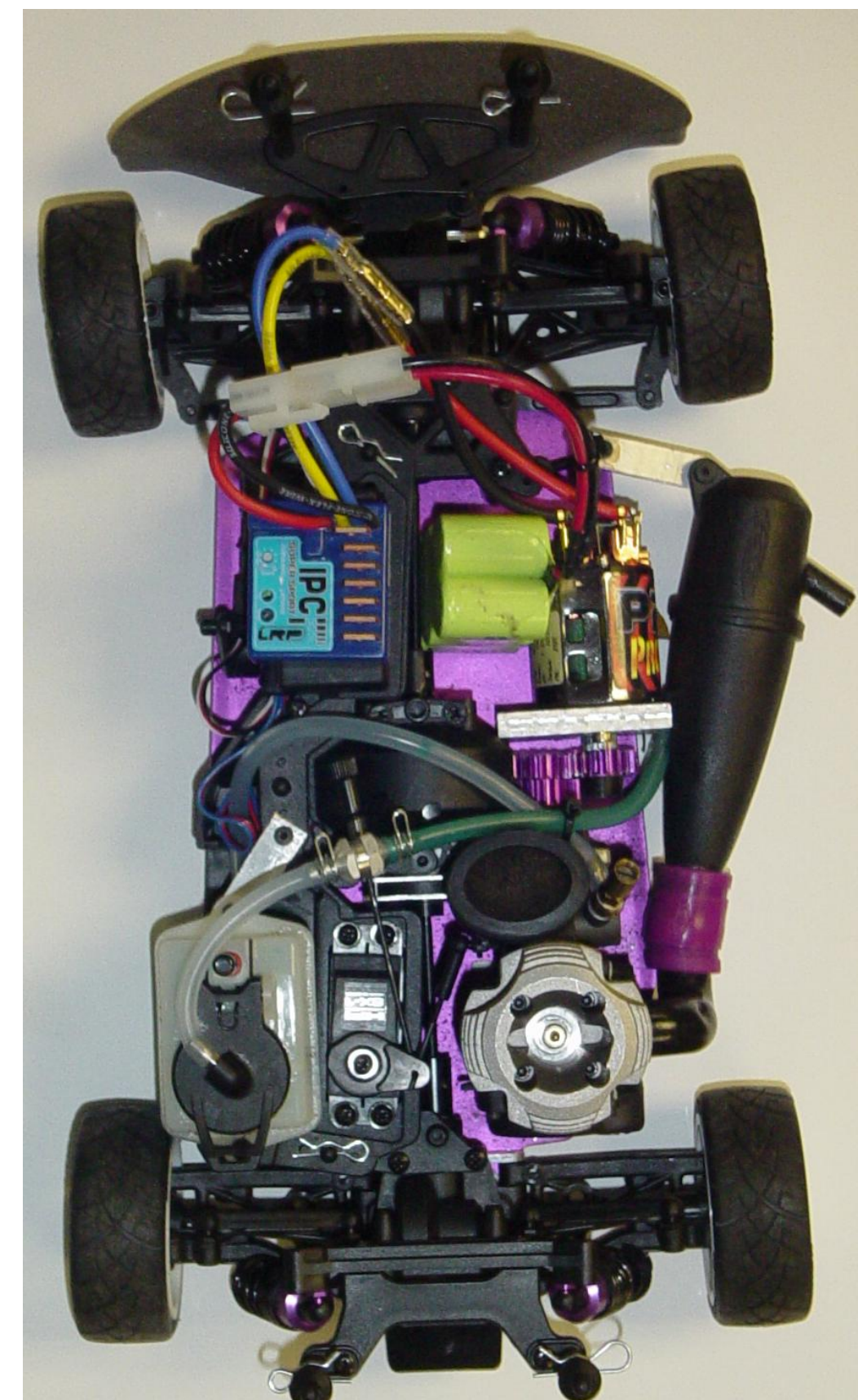
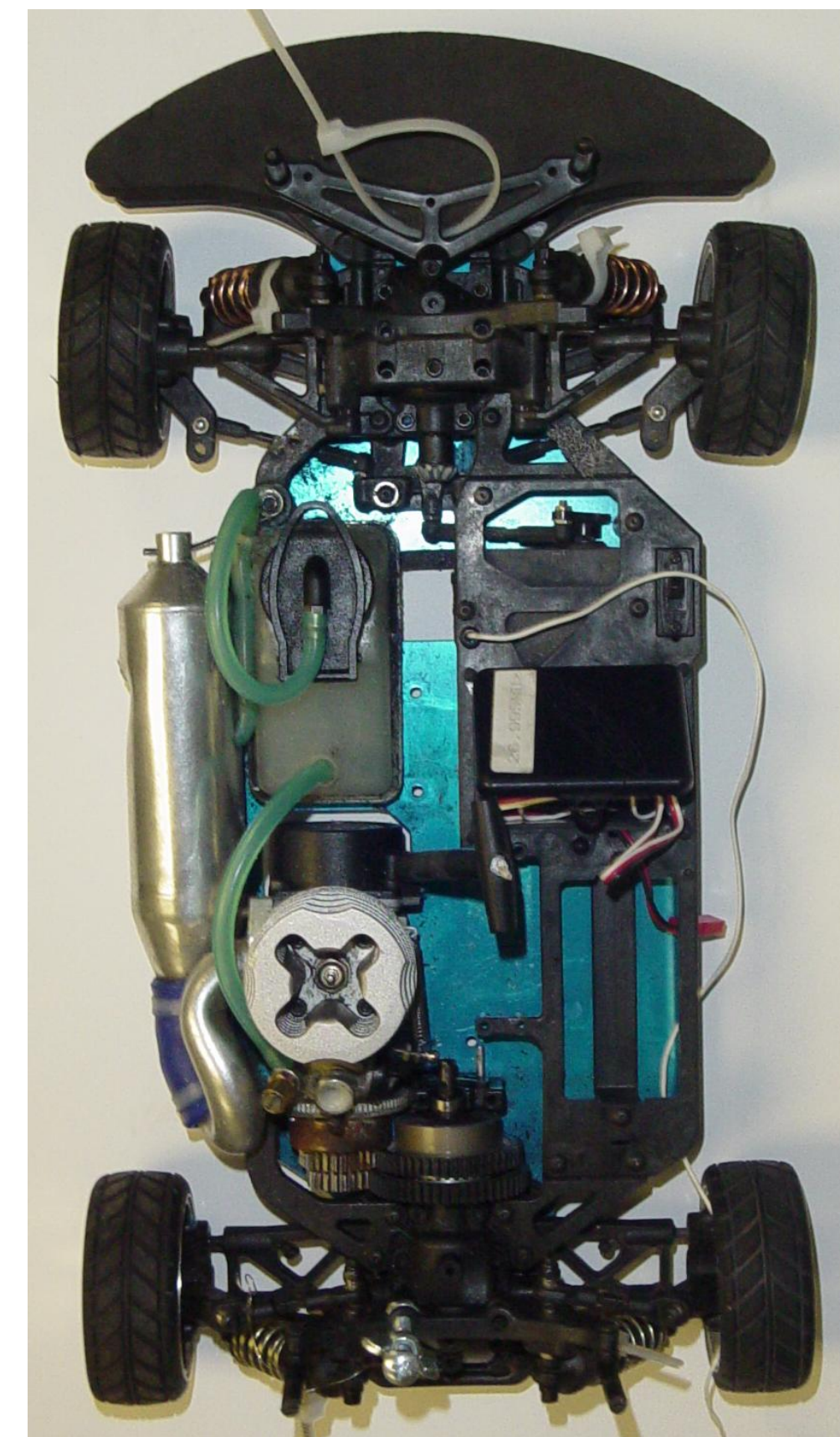
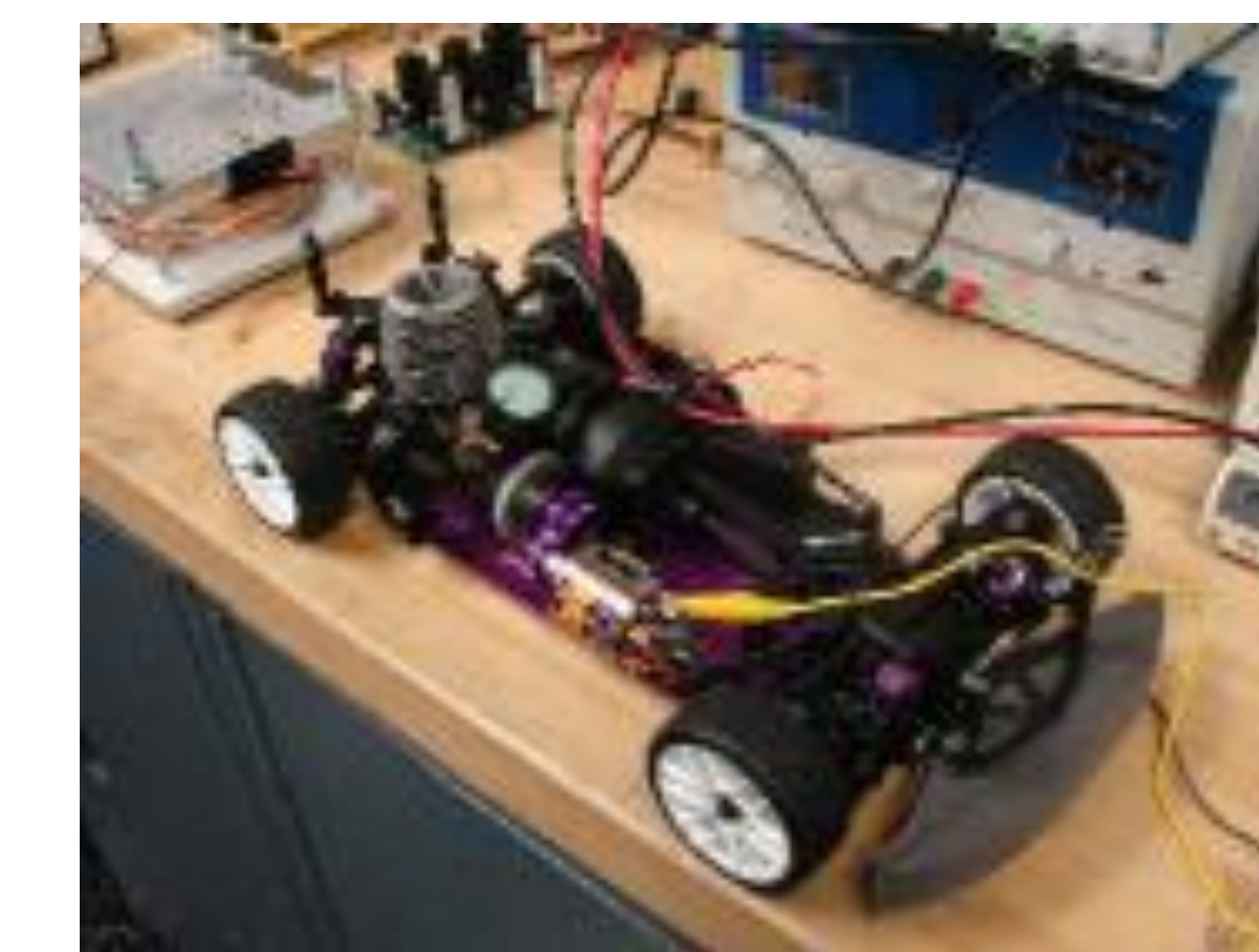

Efficiency

- Electric motors are more efficient over a wide range of speeds, but are often less powerful than ICEs.
- ICEs are more powerful, but are only moderately efficient, and only over a small range of speeds.
- Using both in combination, efficiency can be maximized while still meeting the power and speed demand.



How this Car was Hybridized (for Performance)

- Initially, the car possessed only an ICE for power. This was supplemented by the addition of a DC motor.
- The DC motor is attached in parallel to the ICE at the drive gearing.
- Throttle control for the ICE and current control for the motor are run from the same RC channel. When the vehicle is made to accelerate, both the ICE and motor supply power.

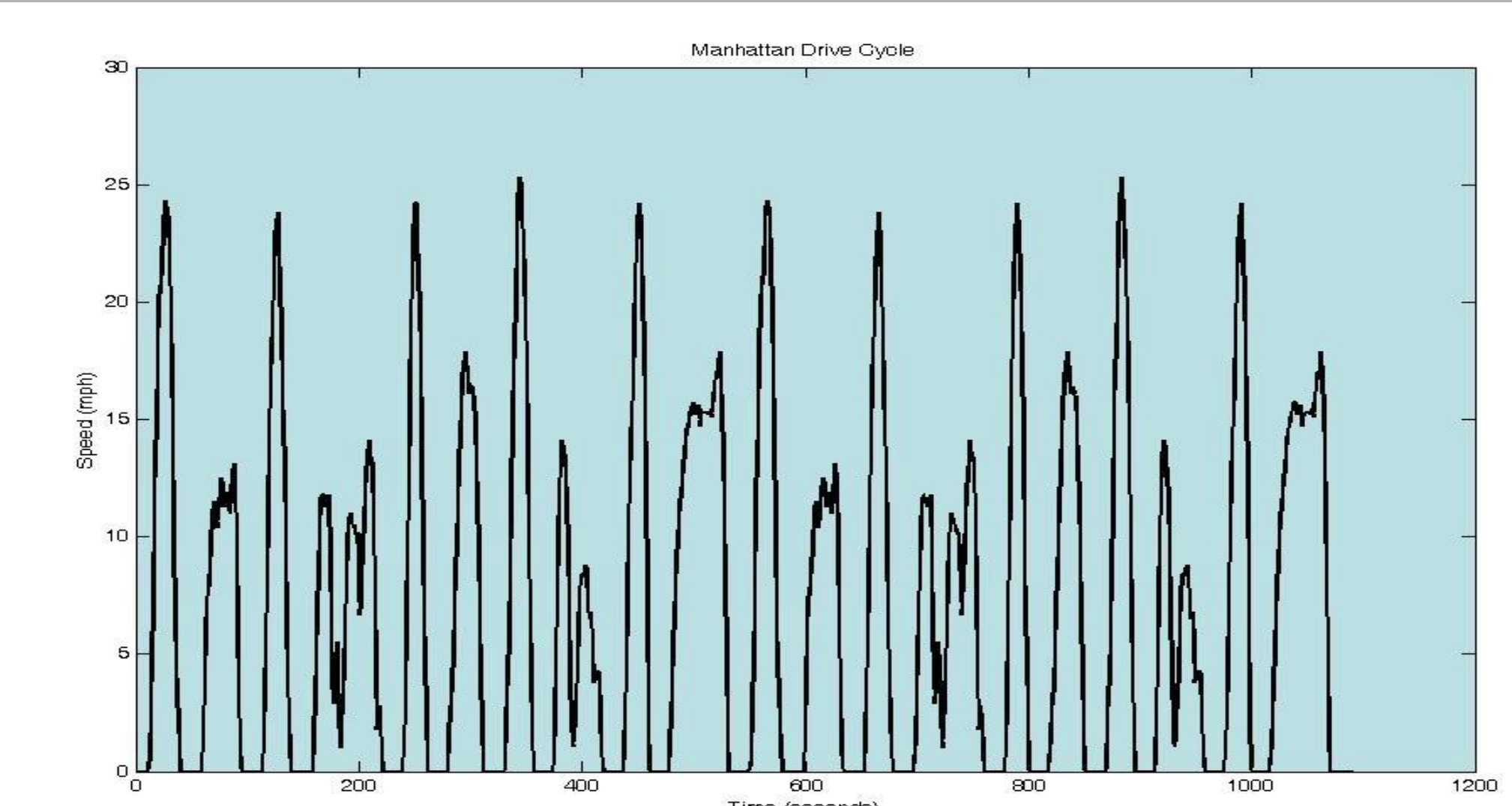
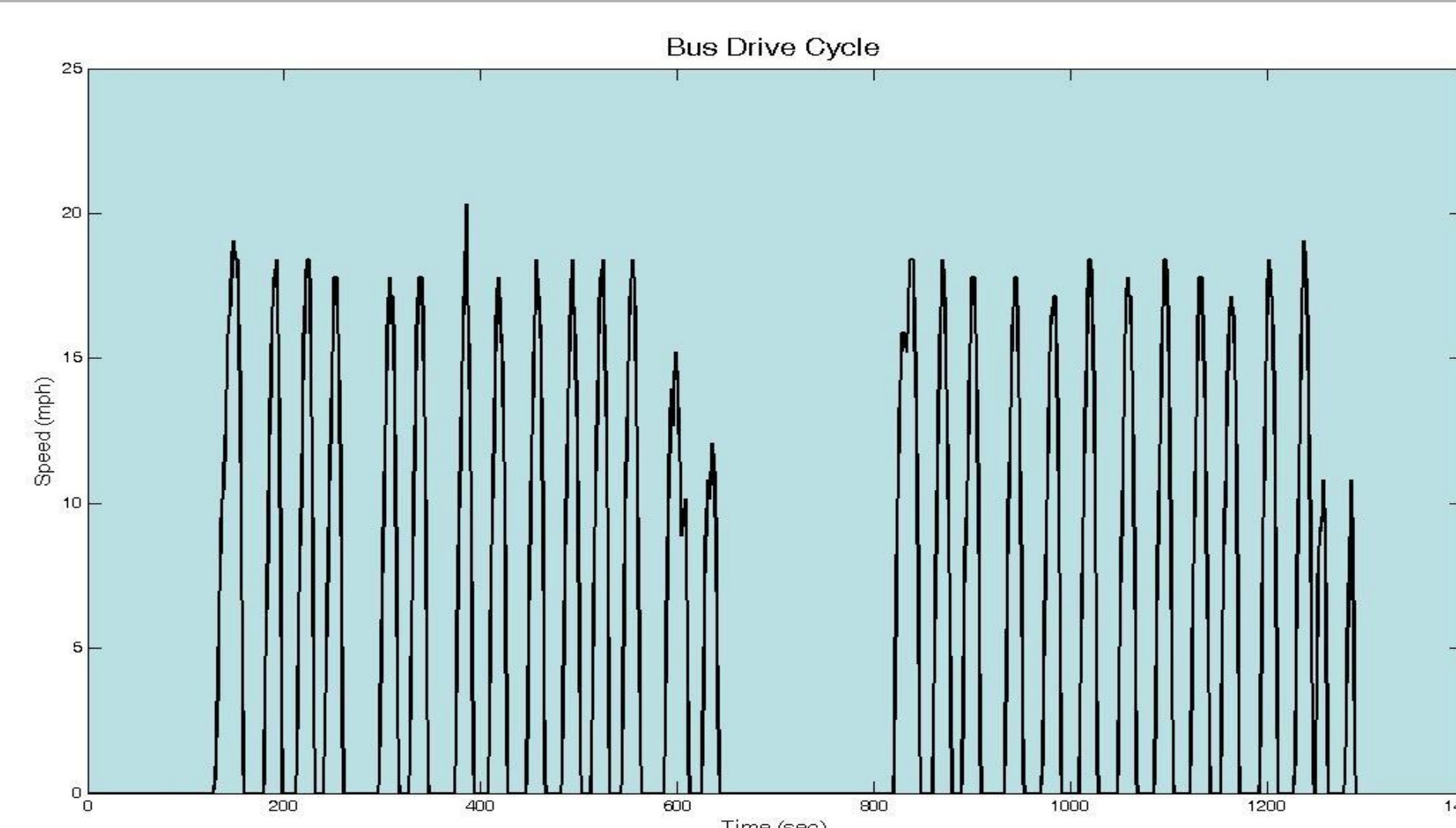
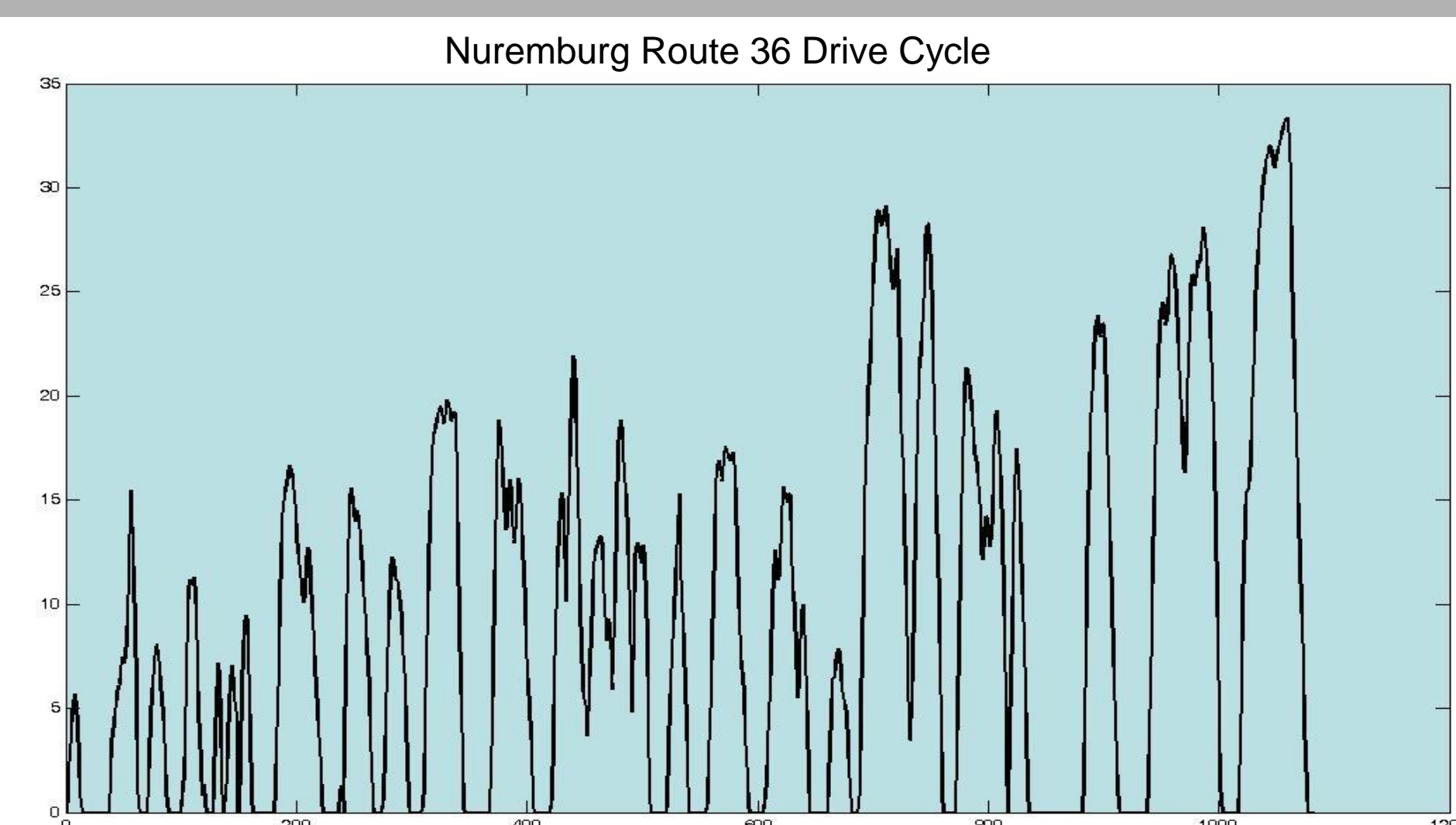

Dynamometer

Dyno

- The Dyno tests the motor using three phase power for hybrids showing the effectiveness of the small system modeling.
- The electrical circuitry can be used on the larger scale test bed.
- The inverter converts DC voltage to AC voltage.
- This provides an opportunity to explore the function of dSpace.

Current Sensors

- The current sensor is able to tell which of the phases, A, B, or C, are on or off to tell dSpace which position the motor is in.

Isolator Circuit

- It keeps high power circuitry electrical isolated from the dSpace system in case of circuit failure.

dSpace

- The dSpace system contains real-time hardware based on PowerPC technology and I/O interfaces: ideal for developing an electric motor controller.
- The installation of a dSpace system, upgrades any PC to a powerful development environment for rapid prototyping.
- dSpace provides a real-time interface for motors to Simulink/MATLAB to graphically display the motor functions, the I/O, and to control the motor.
- Reduces time spent debugging code.

Lead Acid Battery Pack

- High power to weight ratio.
- Less expensive compared to NiMH batteries.
- Readily Available
- Charge Time: 5-10 Hours
- Life Span: 3-4 years or about 200 Charges

Power Electronics

- The battery supplies one phase power, the inverter converts it to three phase power required by the motor.
- An inverter is used to convert DC to AC.
- MOSFETs are a key part in the inverter circuit, they are used as ON/OFF switches.
- A Gate Driver is also needed in the inverter to amplify 5 volts to 15 volts.

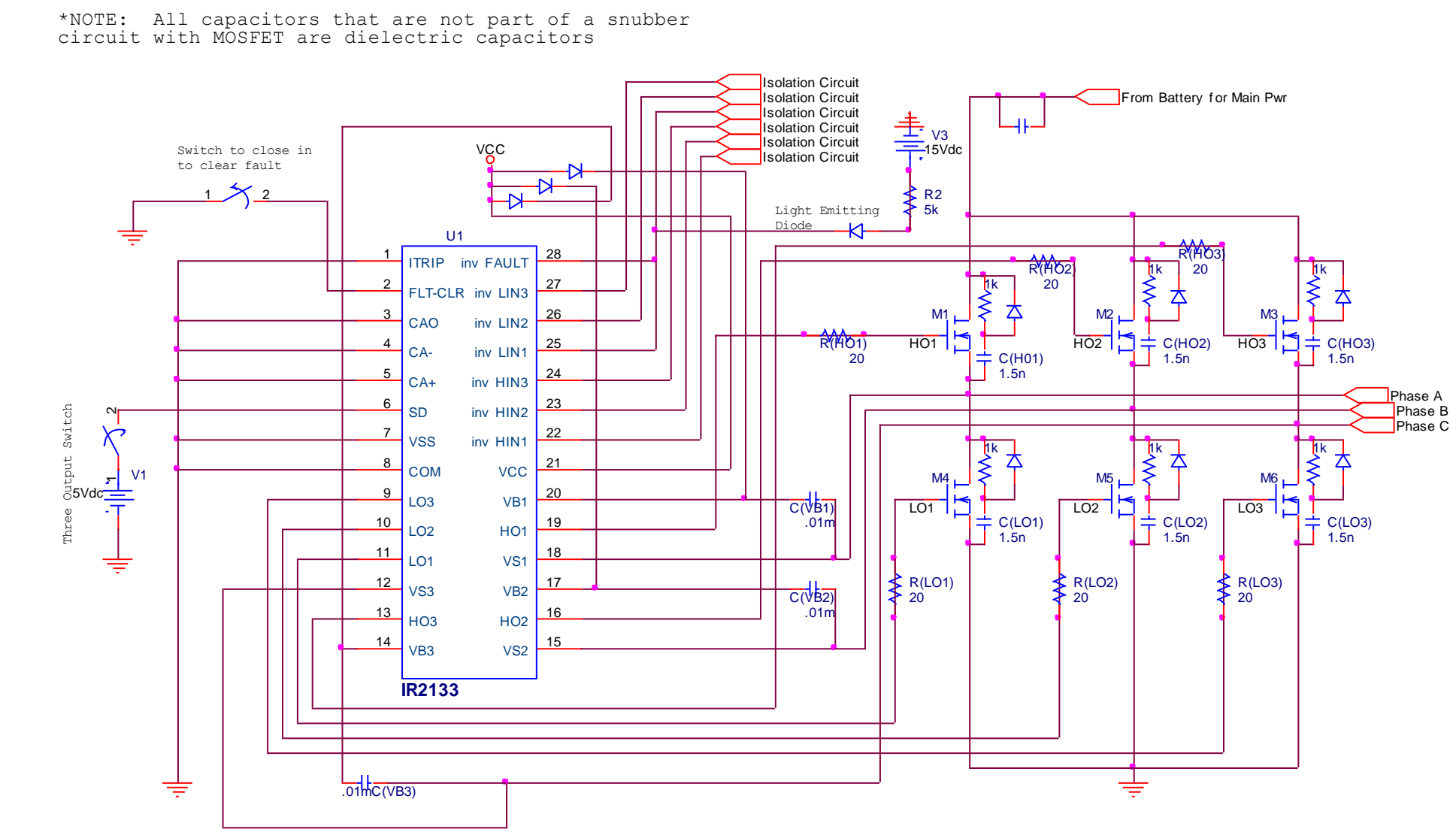

Electric Motor

- The turning of the rotor is caused by magnetic fields which are created by running current through the windings in the stator.

Solution:

- Of the possible motor types the permanent magnet (BLDC) has several advantages:
 - ✓Very high torque to inertia ratio
 - ✓Zero out-gassing (no brush dust)
 - ✓Very high peak torque
 - ✓Very high reliability (no commutator or brush to wear out)
 - ✓Potentially higher efficiency (due to no brush friction)
 - ✓No sparking due to brush wear
- The decision to use a brushless motor requires the design of an electronic solid state switch system including an inverter, isolator, and current sensors.

Mechanics

- The base of the dyno provides a stable, rigid support for the motors and other moving parts.
- To keep mechanical losses low, vibration must be kept to a minimum.
- High rigidity keeps vibration amplitude low.
- Component alignment is held to tighter tolerances, keeping components from vibrating
- Wood base improves rigidity of bed, and also absorbs some vibration
- Reinforcing bars improve rigidity of brackets

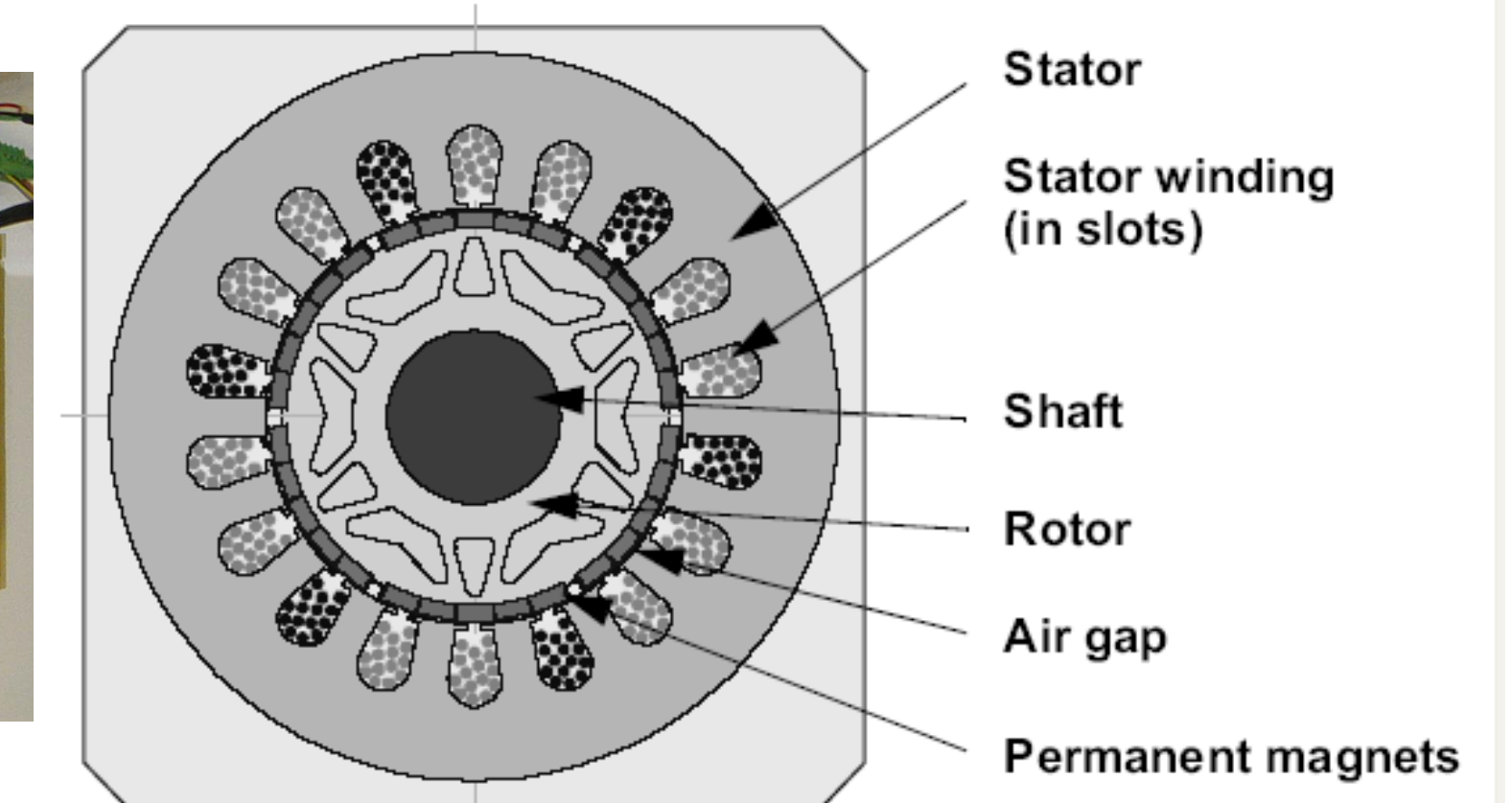
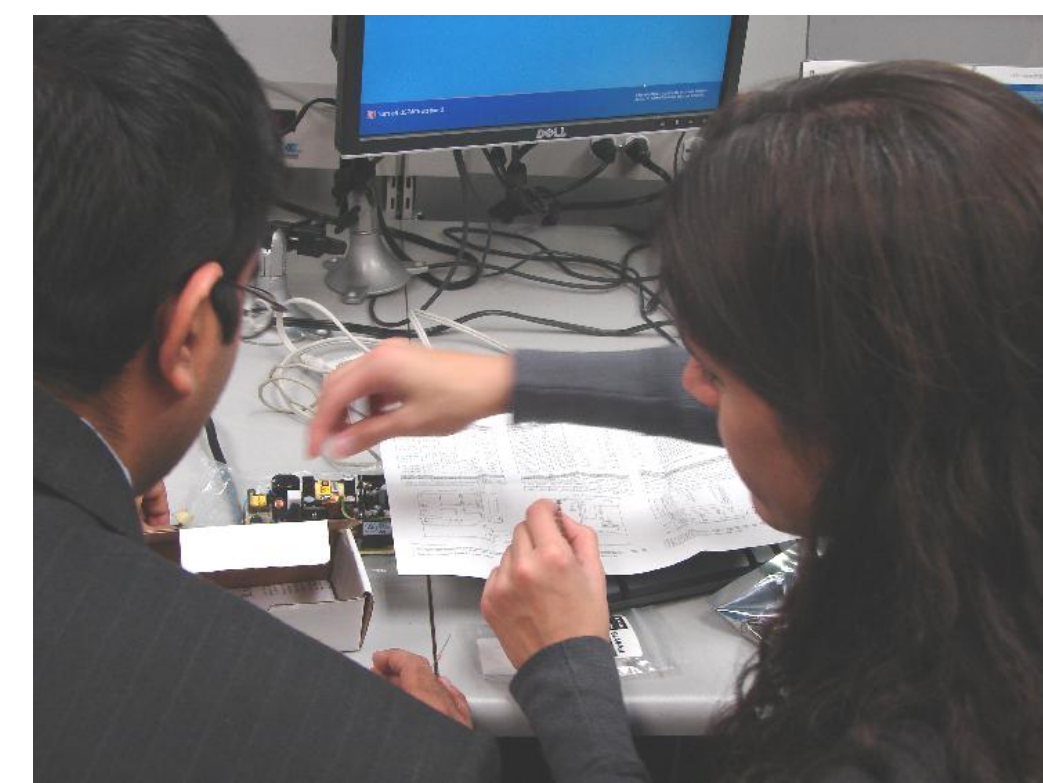
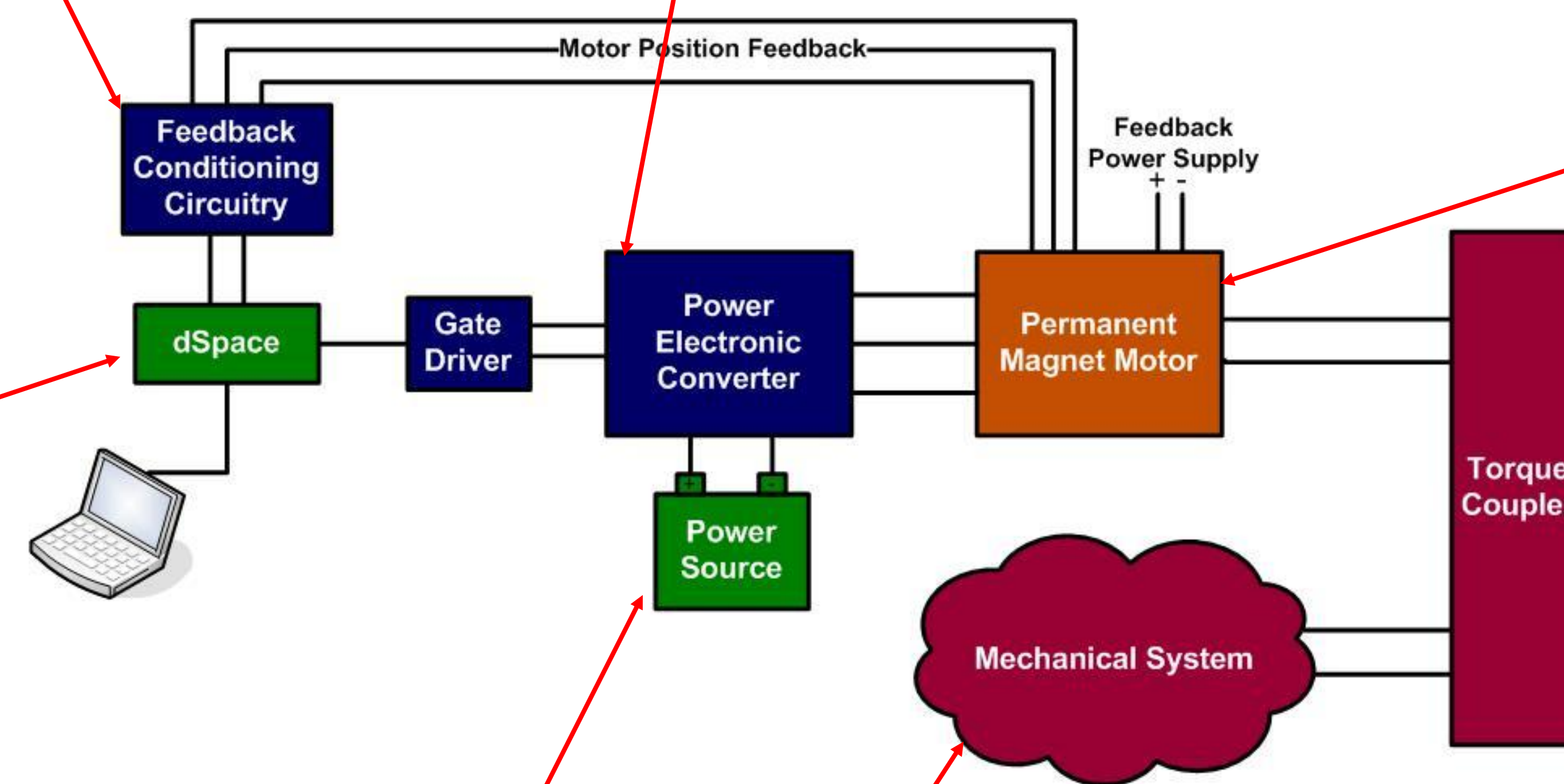

Picture courtesy of Wikipedia.com

