

BUOY

I PRO 310

Assistive Devices for Blind and Visually Impaired Swimmers

A vision for blind swimmers

Buoy Mission Statement

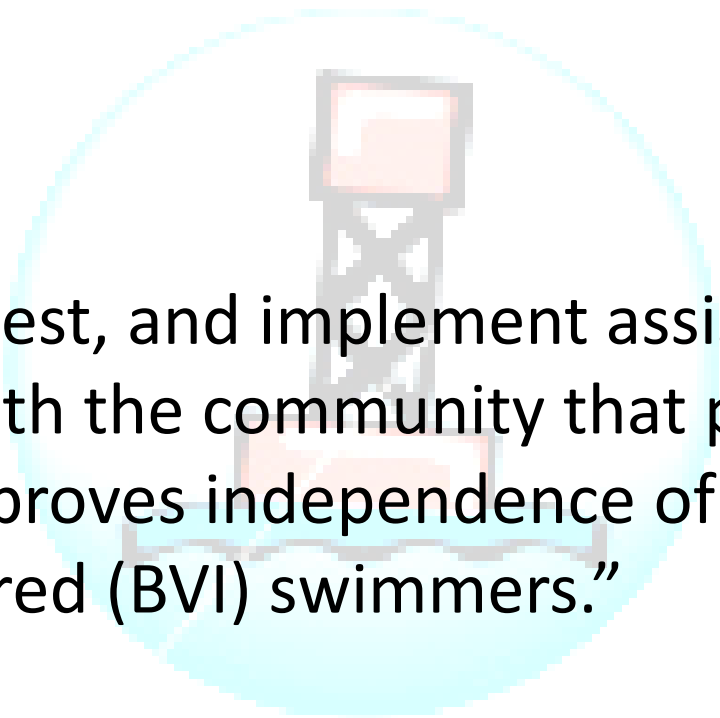

“To develop, test, and implement assistive technology with the community that promotes safety and improves independence of blind and visually impaired (BVI) swimmers.”

Outline

- History
- Problem Statement
- Team Organization
- Goals
- Prep. And Supp. Activities
- Progress
- Future Activities





History

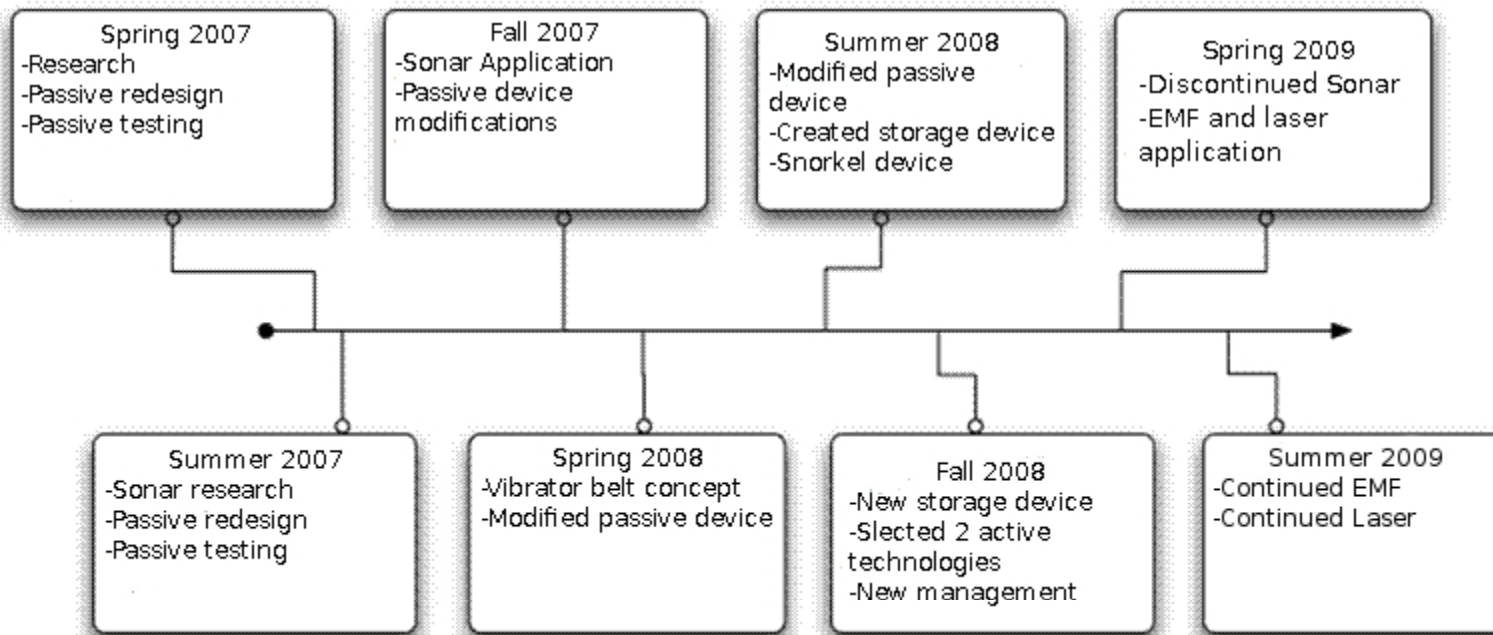

Problem Statement

Background:

- 1.8 million people with blind condition in the US (US Census)
- 7.8 million people with blind and visually impaired (BVI) condition in the US (US Census)
- Lack of user input in development of technology to increase physical activity and decrease sedentary lifestyle
- Up to 80% abandonment rate of assistive technology (Michigan Dept of Education)

Fall 2009 Problems:

- Signal produced by invisible fence is encrypted thus vibrating receiver doesn't work
- Serial problem solving approach was not time efficient

Team Organization

Technology Team

Phillip Sirk (CS, CPE): LEAD
Ross Ludwig (MMAE)
Jeffrey Reilly (Phys)
Branden Toro (MMAE)

Communication Team

Jay Park (Psyc): LEAD
Kimberly Dykeman (Psyc)
Michaela Heaton (Chem)
Timothy Lipman (Psyc)
Smita Sarkar (BME)

Documentation

Michaela Heaton (Chem): LEAD
Jeffrey Reilly (Phys)
Branden Toro (MMAE)

Media

Smita Sarkar (BME): LEAD
Jay Park (Psyc)
Phillip Sirk (CS, CPE)

Survey

Kim Dykeman (Psyc): LEAD
Timothy Lipman (Psyc)
Ross Ludwig (MMAE)

Faculty and Advisors

Frank Lane (Rehab Psyc), Ken Schug (Chem), Ruthanna Gordon (Psyc)

Goals

- Re-design the invisible fence into a radio device and re-design the vibrating receiver to detect signal of new device
- Develop a method of communicating available information between device and swimmer
- Continue BVI community involvement, Maintain website

Prep. and Supp. Activities

- Team building
- Transition to conference room
- Blindfold experiment
- Strategic division of labor
 - Communication
 - Technology
- Completed project plan
- Posting minutes
- Completed IRB certification
- Ethics training and code of ethics
- Chicago Lighthouse tour and survey planned
- SME blind swimming instructor

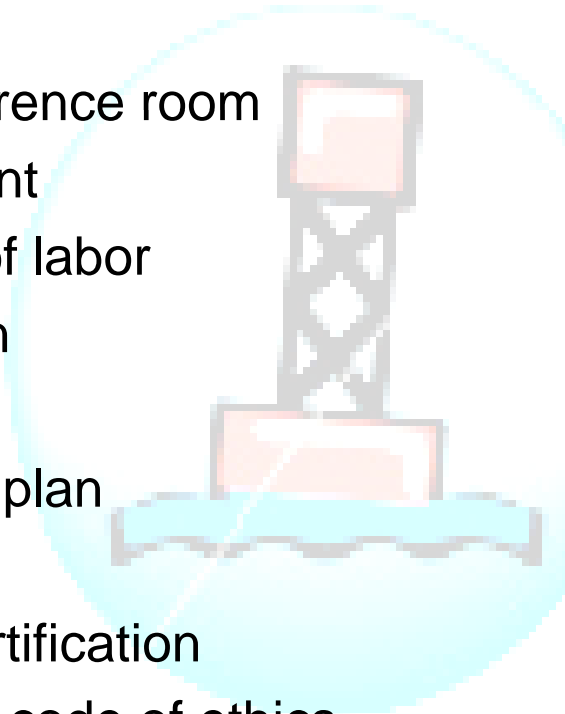

Technology Team Progress

- Ruled out magnetic system
- Researched transmitters and receivers
- Designed a new transmitter device
- Circuit analysis
- Ran circuit simulations
- Simulation shows a functioning transmitter
- Working on circuit for new receiver

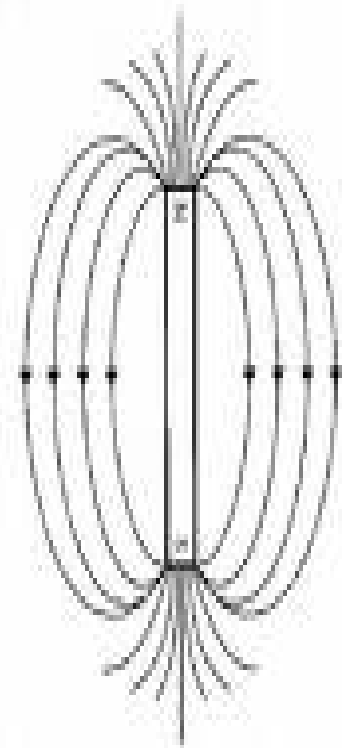
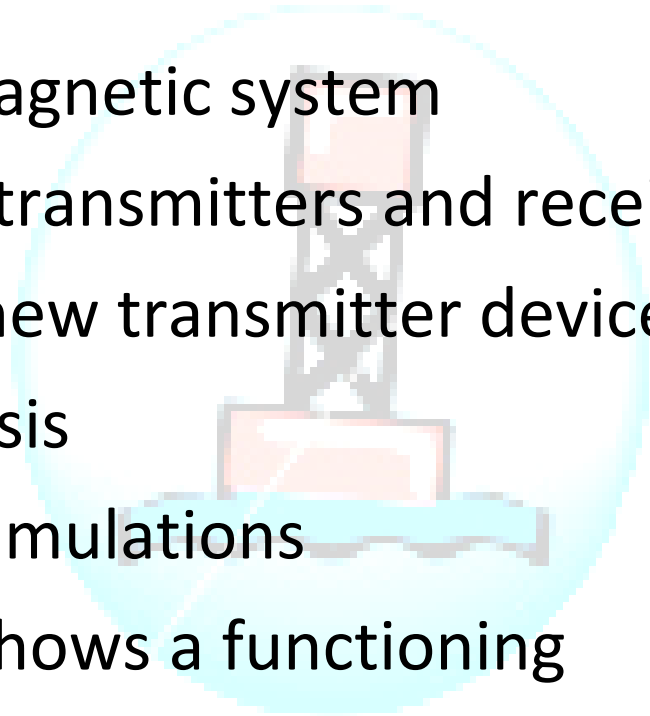

Radio

- Transmitters produce an invisible wall by broadcasting a unique signal
- Receiver detects signal and produces tactile feedback indicating relative position to obstacles

Simplest RF Transmitter
<http://www.uoguelph.ca/~antoon>

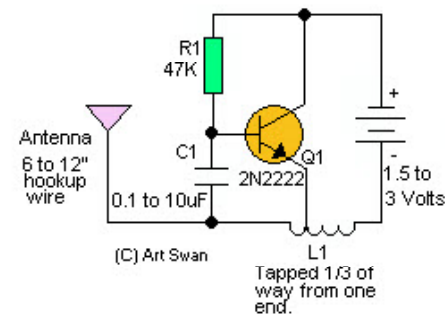

Radio

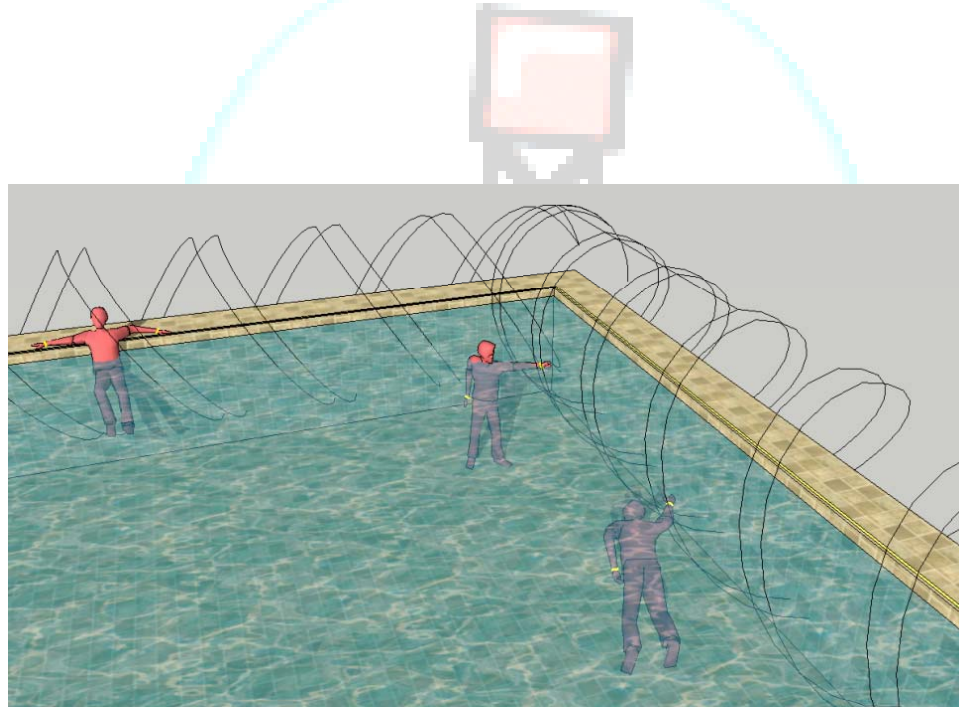

Communication Team Progress

- Review of literature
- Review of methodology for mobility training for BVI individuals
- Established pilot protocol for training
- Tested protocol
- Revised protocol
- Continuing testing

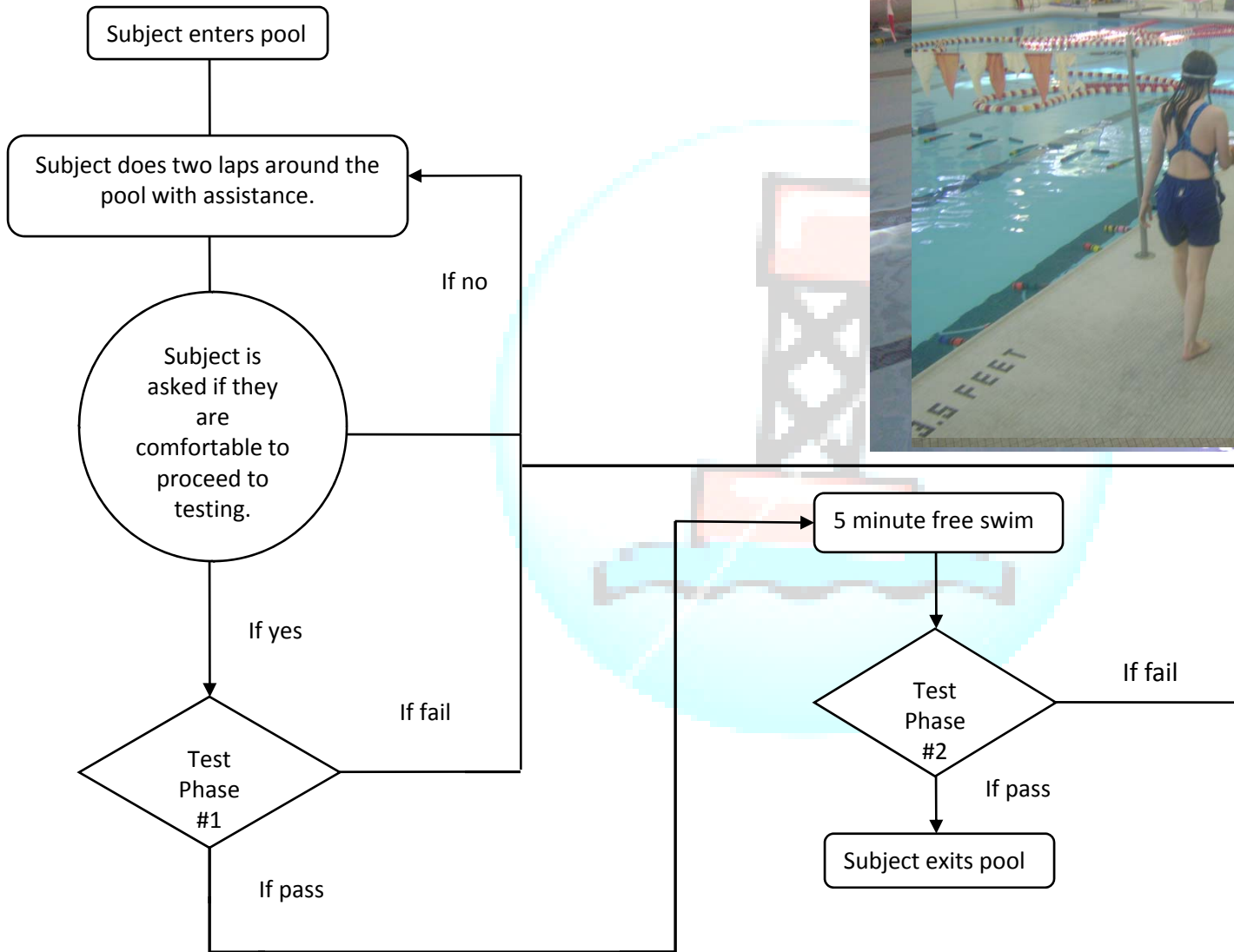
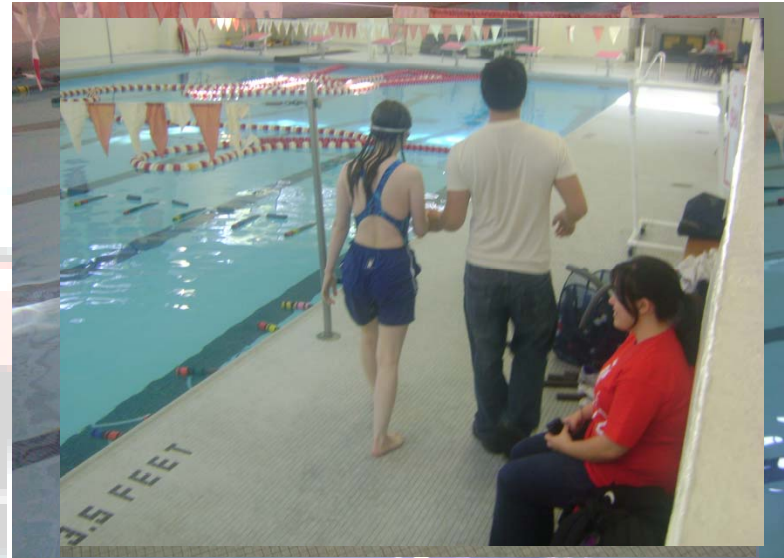

Future Activities

- Complete design for vibrating circuit
- Build receiver
- Build transmitter
- Implement training protocol
- Visit Chicago Lighthouse for tour and survey
- Determine applicability of device for other exercising activities

Needs / Questions / Requests

- Continued communication with subject matter experts
- BVI community for testing



