



Rapid Manufacturing of Casters

Sponsored by *Colson Associates*

Final Project Report

I PRO 312
Spring 2006

Faculty Advisors:

Doctor Keith McKee
Professor Will Maurer

Student Members:

Abel Blasco Comeche, Mohit Bansal, Udit Dave, Mike Choi, Relana Gomes,
Kue-Dong Park, Jim Sherrod, Will Asherman, Aicha Thiam

Table of Contents	Page #
1. Introduction	3
2. Objective / Goals	4
3. Team Organization	5
4. Conceptual Designs	5
I. Concept 1	5
II. Concept 2	10
III. Concept 3	16
i. Concept 3.1	16
ii. Concept 3.2	18
5. Meeting with Mr. Pritzker	20
6. Future Steps	21
 Appendix	
Appendix A - Trip to Albion	23
Appendix B – References and Bibliography	27

1. Introduction

This IPRO started as a *Rapid Prototyping* project to make casters in a short time period.

As the project advanced, and after the visit of Mr. Pritzker, owner and CEO of *Colson Associates*, the team realized that the real **objective** of this IPRO is:

- Investigate techniques for rapidly and effectively manufacturing casters to satisfy "rush orders" for special casters.

The next step for the group was to understand how a caster is formed and learn about all the parts that are used. *Picture 1* is an example of a popular caster, with all the parts detailed.

The group was divided in groups of two people to evaluate alternatives to manufacture every single part in 24-hour period.

Some of the ideas that came up are:

1. Replace *Stamping* processes for *Cutting* processes.
2. *Powder coating* the stainless steel, seems to be a better option than *Zinc coating*.
3. Use *bending* techniques instead of *welding*.
4. Use already made bearings (self-lubricating ones) as an alternative for *Hardening* the raceway
5. *Machine* the Stems
6. Go with the *kingpin-less* design and instead of attach a flat-plate on top. Now, the idea is to come up with a standard way of attaching the stems to the plate regardless of the stem chosen by the costumer.
7. *Slotting processes*→ find a way to make the slots used for locking

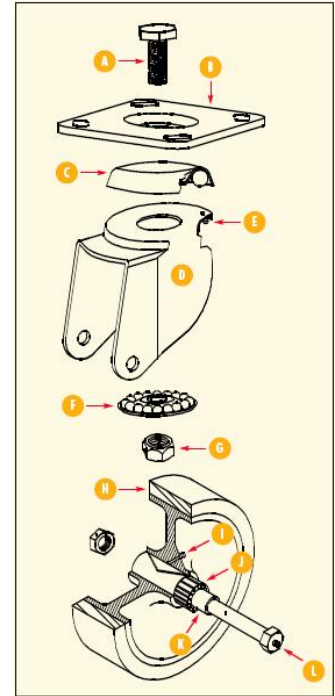

Picture 1

On February 28th the team visited one of the facilities of Colson Associates, Albion in Michigan. The goal of the visit was to learn more about casters and the way they are currently manufactured by Colson Associates. This trip would allow us to have a clear idea on how what is involved in making a caster; also, we hoped that plant engineers present would be able to paint a better picture of what they expect from this project.

NEW GOALS

The visit warranted some changes to the overall goal of the IPRO. Here are some of the suggestions that we decided, as a group, to concentrate in doing:

- *Try to deliver a design and manufacturing of the caster without the wheel. Future semesters' groups can work on that part.*
- *Distance ourselves as far as possible from the present design and manufacturing. Therefore, let's act as if we are doing something completely different.*
- *Heat treatment is the main concern for the bearings and raceways. Therefore, find a different alternative or have pre-heat-treated components that can be stored and used when needed.*
- *Come up with a family of processes and a \$ amount figure on how much is needed to make a caster.*
- *Break-up into design groups and process groups to come up with a new scheme for the caster making process.*
- *Come up with an easy and simple design that is also readily customizable.*
- *An idea is to go with a kingpin-less and make it changeable and possible to accommodate stems.*
- *Another IPRO group is working on different cutting techniques. They can give us good suggestions and information about the different cutting processes: laser, water jet cutting...*

To accomplish these goals the next actions were:

- *The team was divided into 3 teams that had the assignment to come up with competitive designs.*
- *Give enough details on the drawings to explain the ideas behind the design.*
- *Come up with ideas to give the design a fast manufacturing process.*
- *Look for alternatives to heat treatment.*
- *Look also into zinc coating and its possible replacement. Powder coating looks like a good alternative. Get a crude idea of the pricing for powder coating.*
- *Finally, look at bearings.*

2. Objective / Goals

- Reduce lead time to 24 hours at maximum
- Flexibility of caster design to accommodate customer special requests
- Identify and reduce critical time consuming processes:
 - Heat treatment
 - Stamping
 - Welding
 - Coating
- Meet or exceed the performance criteria set by ICWM (International Caster and Wheel Manufacturers)

3. Team Organization

Since the beginning of the semester, we realized that organization of the team was very important. It would allow us to accomplish a lot in a relatively small amount of time. By the third week of classes, upon having a better understanding of the scope of the project, the IPRO team was broken down into four groups. Each group had for task to study a major component of the current caster design. From that study, each group was expected to give a presentation about the components that make up their part, the processes (cutting, heat treatment, etc...) involved in getting those parts, as well as alternatives that will reduce the processing time as much as possible. The main parts investigated were the bearings, the fork, the king pin and the top plate.

From these investigations and presentations, the entire team obtained a better understanding of the processes involved in making a current Colson Associates caster in a fraction of the time that it would have taken each of us to accomplish that same goal. The team was also presented with options for reducing the lead-time of machinery and operation.

Once a better understanding of the product, its development and possible improvement was obtained, new teams were formed to come up with conceptual designs. The conceptual designs had to include everything from material selection to assembly. Each group was to pretty much dream up a new concept for a caster while making sure that the processing time is kept within 24 hrs.

4. Conceptual Designs

Every team came after Spring Break with a competitive design. Two of the designs proposed were close to the designs that Colson is manufacturing nowadays; one was completely different.

I. Concept 1

The caster conceptual design #1 was first made to fit all the goals highlighted above. First, the caster to be designed has to accommodate the special needs of the customers. In the present time, Colson Associates has a wide variety of casters. The different varieties accommodate: stems (usually for low loads) or flat plate (for relatively high loads); different shape forks (to accommodate the different size wheels); different stems (depending on the customer requirements) etc...

The other main goal is maybe the most important for Colson Associates; and it has to do with the processing time. The company wants to be able to process and ship special caster orders within a 24hrs. The third and last goal has to do with the performance criteria. We have to make sure that our design will meet or exceed existing performance criteria based on ICWM (International Caster and Wheel Manufacturers) standards

Basic Concepts

Below are the main concepts used in making the theoretical caster 1. It was imperative to follow the main goals: less than 24hr process time, flexible caster and meet the performance criteria.

- Use of CNC Turning, milling and cutting
 - Creates Flexible Manufacturing
 - Eliminates the need for hard tooled stampings.
 - Removes need for forging processes and associated forging dies.
 - Eliminates requirement for casting processes and required cores.
- Completely remove the process of Welding
 - Eliminates the need for special welding fixtures
 - Reduce cost between use of skilled worker vs. assembler
 - Reduce lead time
 - Provides smoother surface, and improves appearance of caster
- Flexible use of laser
 - Cutting
 - Heat treatment of raceway

Laser heat treatment was used for this design because it allows for accurate heat treatment for the bearing raceways. It removes all need for surface coating before the treatment; which is both a time saver and less labor intensive. The thickness of the material used is enough to self-quench. Finally, the same laser can be used for both heat treatment and cutting. Therefore, reducing the machinery count and cost.

Exploded Drawing

The exploded drawings presented below show the main components involved in the conceptual design. They also highlight the assembly process involved in making both a stem and a stem-less caster.

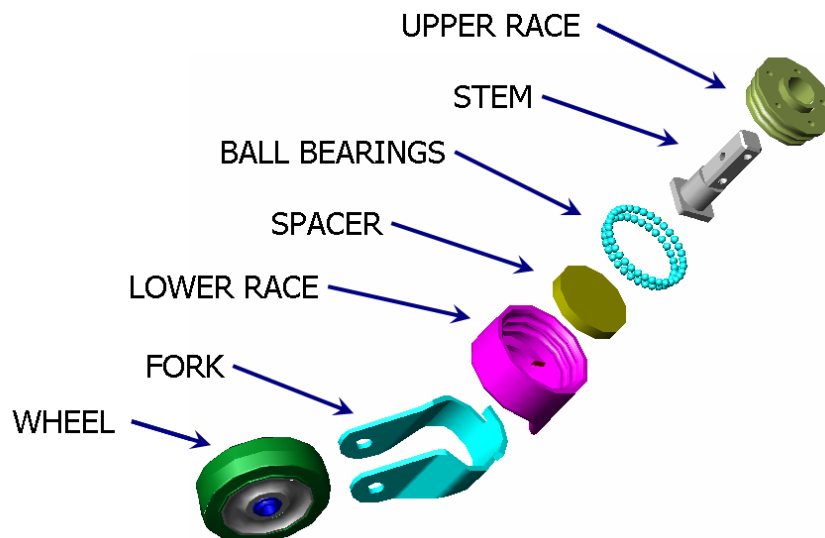

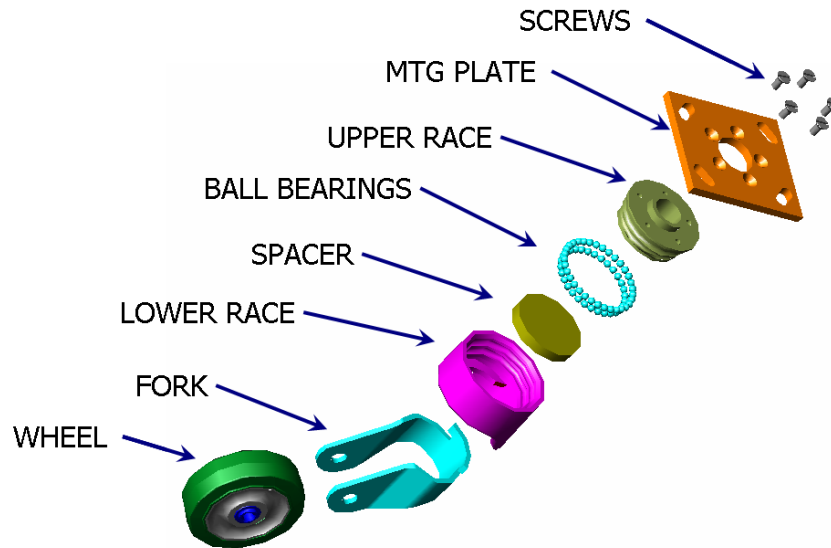

Next, let's look at the main components of the design and the procedures involved in making them.

Parts

Next is the list of the main components involved in making the caster. Also highlighted are the material, operation, and machinery used in making them.

- Stem
 - Material: Bar Stock Round or Hex (Typically 12L14)
 - Operation: Turning, milling, tapping, threading
 - Machinery: CNC Horizontal lathe

***UPPER STEM** varies
by customer requirements*

***LOWER STEM** maintains
common shape for assembly*

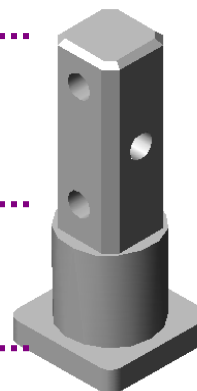

As explained in the picture above, one of the goals in the new design was to be able to accommodate special orders of casters. Therefore, while envisioning the caster and its different parts, we wanted to make some pieces standard in order to facilitate the process and assembly of special orders.

- Plate
 - Material: Sheets or flat plate Cold rolled or hot rolled 1008,1010,1018
 - Operation: Cutting, counter sink drilling
 - Machinery: CNC laser

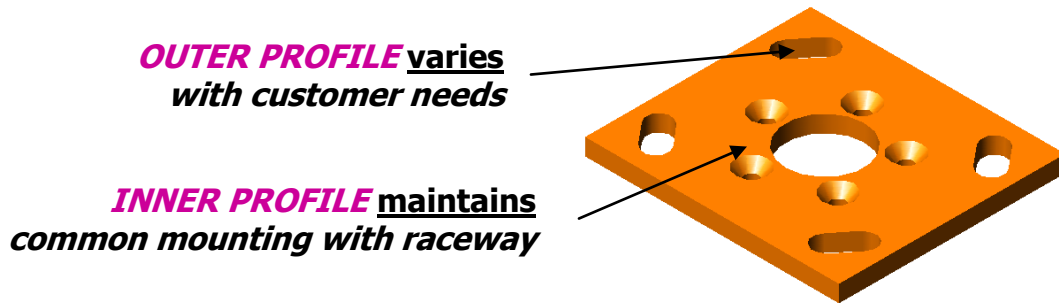

- Fork
 - Material: Sheets, Hot or Cold rolled (Typically 1008, 1010, 1018)
 - Operation: Cutting, Offset Bending, Forming
 - Machinery: CNC Laser, CNC Horizontal Press

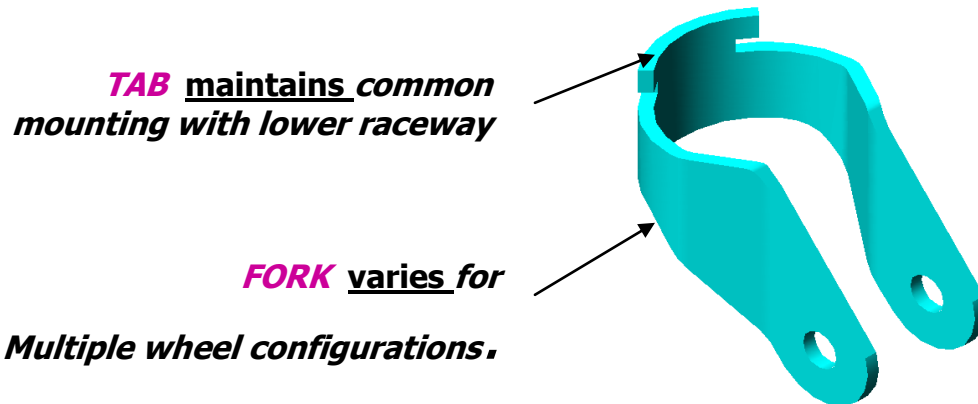

- Upper raceway
 - Material: Thick-walled tubing or solid bar (Pre-cut from vendor)
 - Operation: Turning, Boring, Tapping, Heat treating (localized)
 - Machinery: CNC Horizontal Lathe, Laser Heat Treating Device

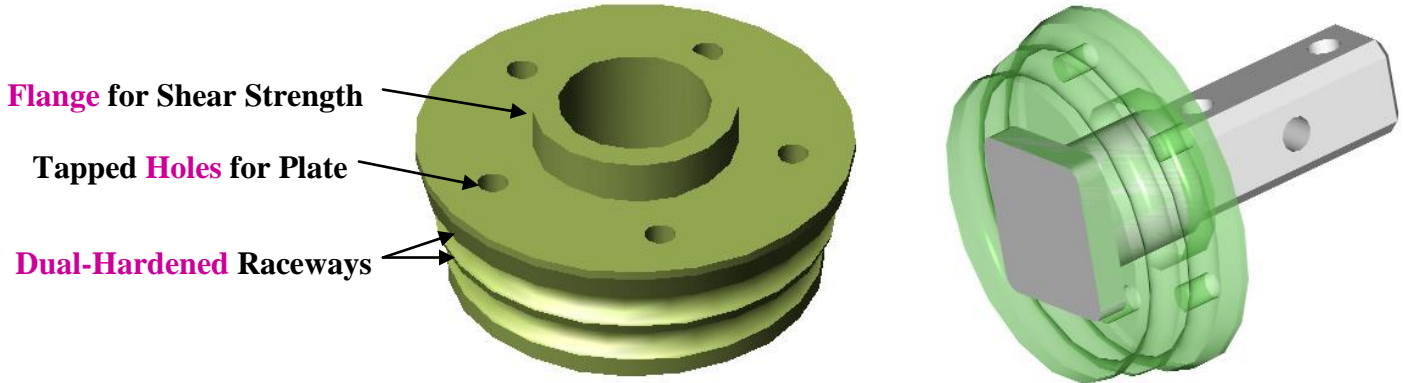

The two pictures above show two views of the upper raceway. They highlight the different parts of the component as well as the keyway that will accommodate the stem. It is important that the raceways have to be hardened because they will house the ball bearings.

- Lower raceway
 - Material: Thick-walled tubing or solid bar (Pre-cut from vendor)
 - Operation: Turning, Boring, Tapping, Heat treating (localized)
 - Machinery: CNC Horizontal Lathe Laser Heat Treating Device

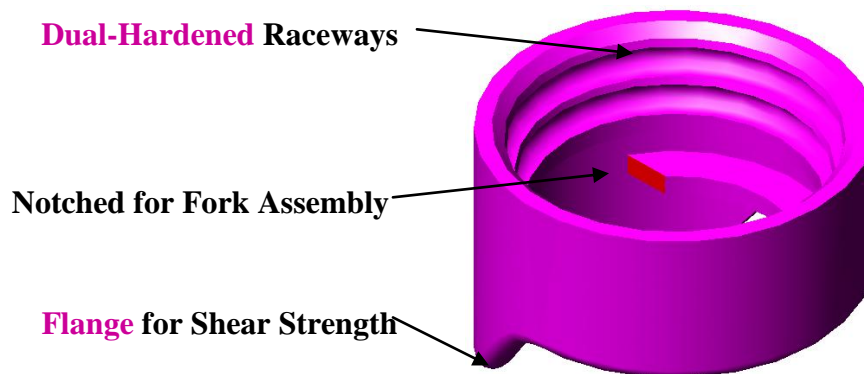

The notch in the lower raceway will serve as a keyway for the tab of the fork. The dimensions of the notch will remain the same for all caster configurations and sizes because its tab will maintain the same configuration. The lower race of the raceway will lock the fork in place and prevent it from falling down. Caution has to be taken however to prevent the fork from bulging up. Therefore, we came up with the next component.

- Spacer
 - Material: Solid bar
 - Operation: Cutoff Turning
 - Machinery: CNC Horizontal Lathe

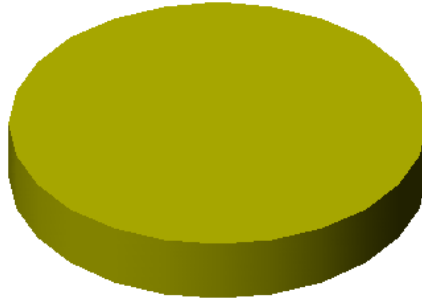

As a whole, here are the main components of the design. Next, are highlighted the advantages of using the caster design #1.

Advantages

- Looks a lot like the current Colson caster
- Requires very changes in processing “special orders”
- All components can be made by the use of a limited amount of machinery
- No special tooling needed
- Low or no inventory
- Focuses on flexibility: components, machinery, etc...

II. Concept 2

The main difference of this design is the use of **standard tapered roller bearings**.



Tapered roller bearing

Using tapered roller bearings allows us to eliminate heat treatment process. Heat treatment is the biggest time constraint.

This is an exploded view of the caster:

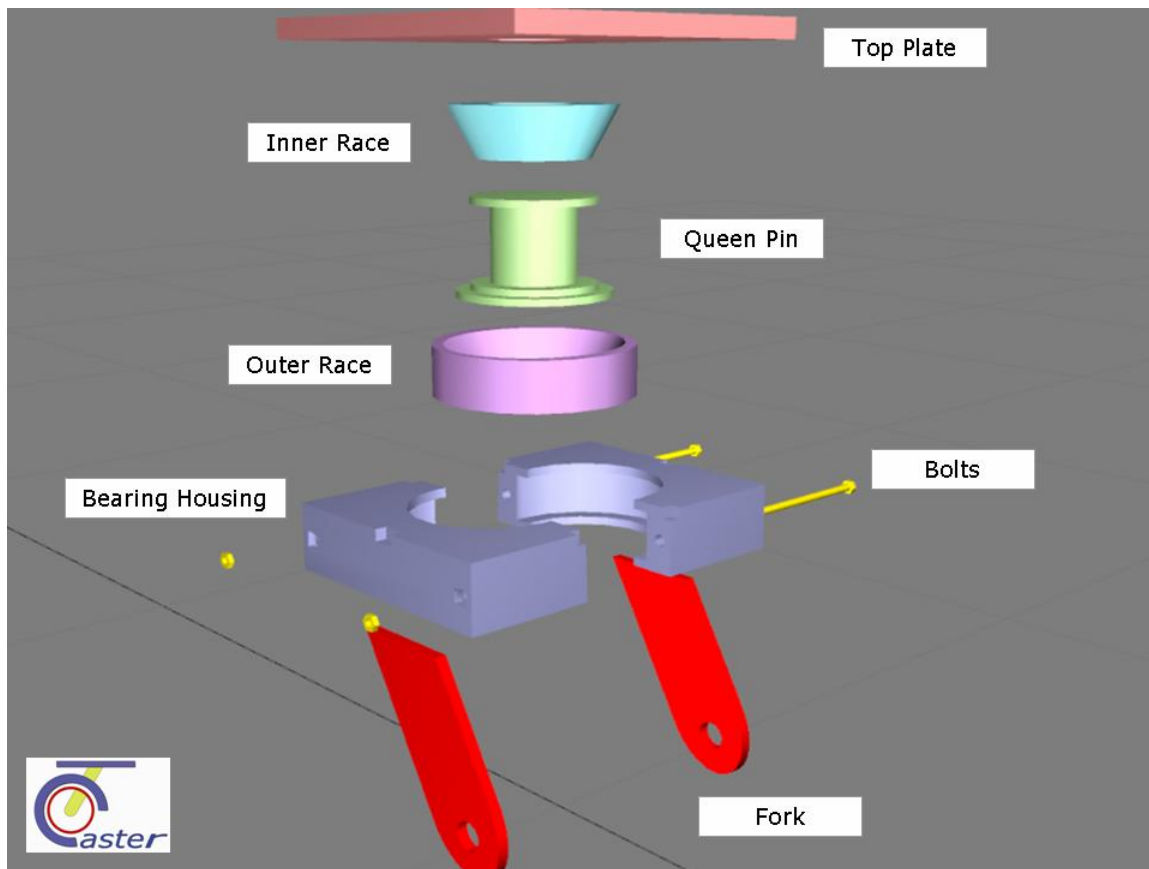

The different **components** are:

- Bearing: **Standard available in market**
 - Function:
 - Allow the swivel action
 - Transfer vertical load



Tapered roller bearings

The outer race of a tapered roller bearing is not joined to the rest of the bearing (as seen in the picture).

- Top plate:
 - Raw Material: Steel
 - Manufacturing Process: Cutting with Water Jet / Laser
 - Function: attach the caster with the bottom surface of whatever is to be moved

Holes for the screws can be customized in different shapes, but the central hole for the Queen Pin is circular.

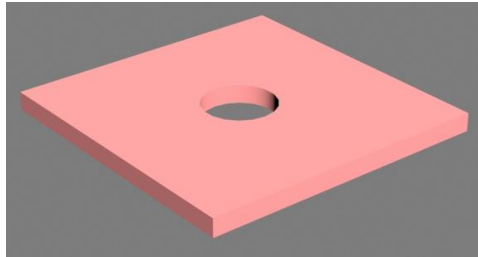

Top plate

- Queen Pin:
 - Raw Material: Steel
 - Manufacturing Process: CNC - Turning
 - Function:
 - Holds top plate and inner race together
 - Lift fork and wheel assembly upward

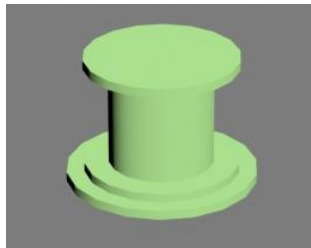

Queen Pin

The top of the Queen Pin is to be screwed.
The bottom of the Queen Pin goes under the outer race without contact it. So if the caster is lifted upward it holds the outer race, fork and wheel.

In this 2-D drawing is possible to see the detail:

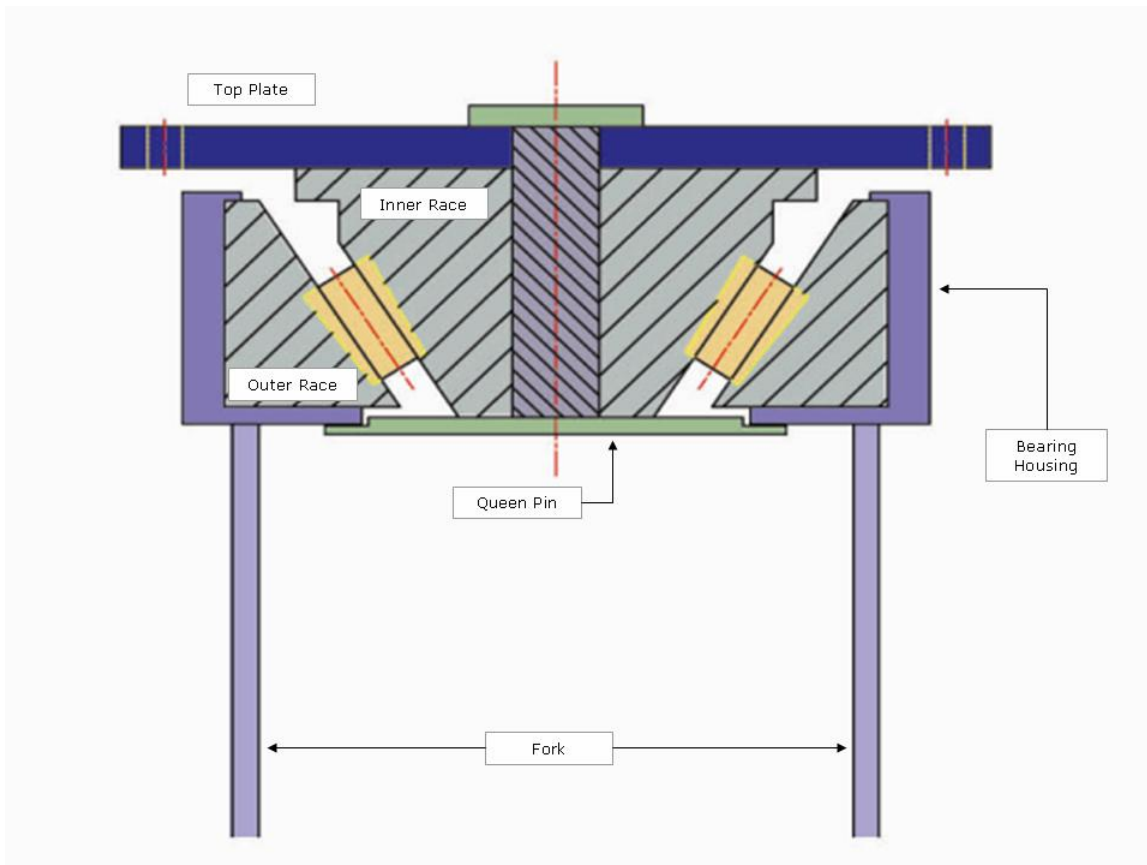

- Bearing Housing:
 - Raw Material: Steel
 - Manufacturing Process: CNC – Turning & Water Jet / Laser
 - Function: Hold outer race of bearing and fork

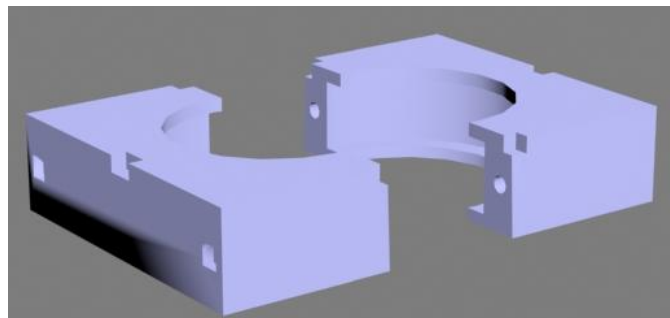

Bearing Housing

Two bolts are used to join the two parts and hold tight the outer race.

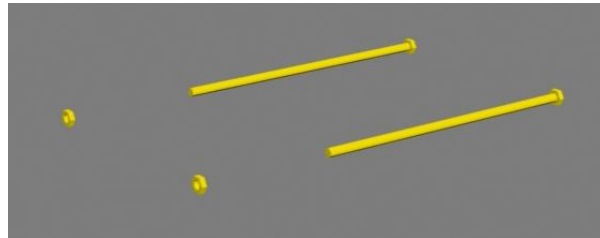

Bolts and nuts

- Fork:
 - Raw Material: Steel
 - Manufacturing Process: Water Jet / Laser
 - Function: Hold the wheel and attach it to the swivel mechanism

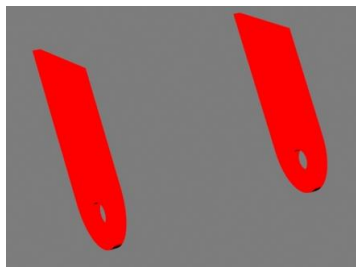

Fork

Alternatives for the fork are:

- Straight fork which needs least machining but need to be thicker and heavier.
- Bent fork, which needs only simple bending and which is moderate in weight.
- Profiled or bubbled fork which needs critical bubbling but with least material.

This diagram explains what the assembly steps are:

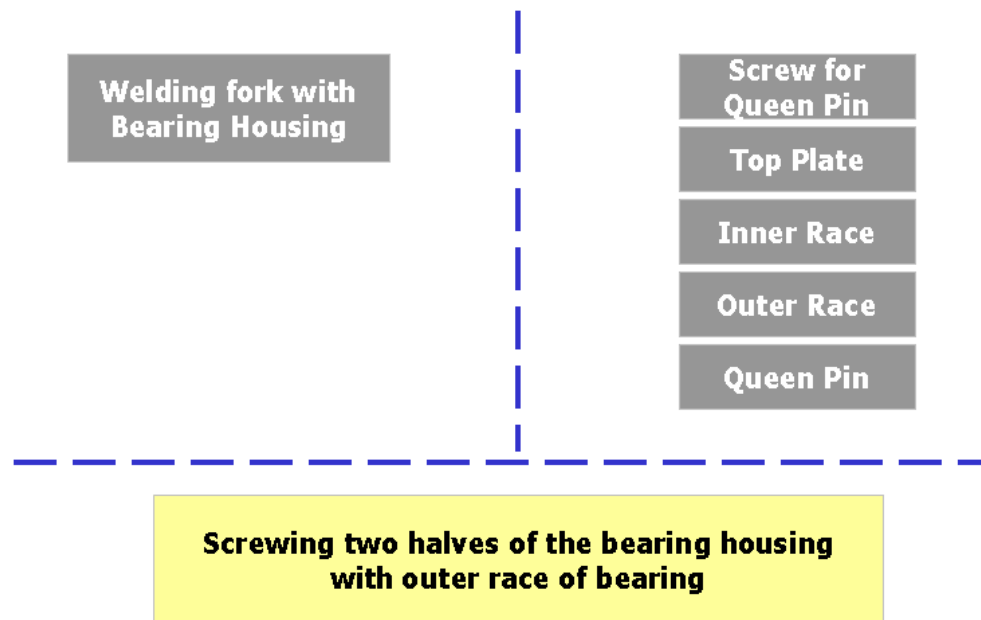

X-Ray view of the whole assembly:

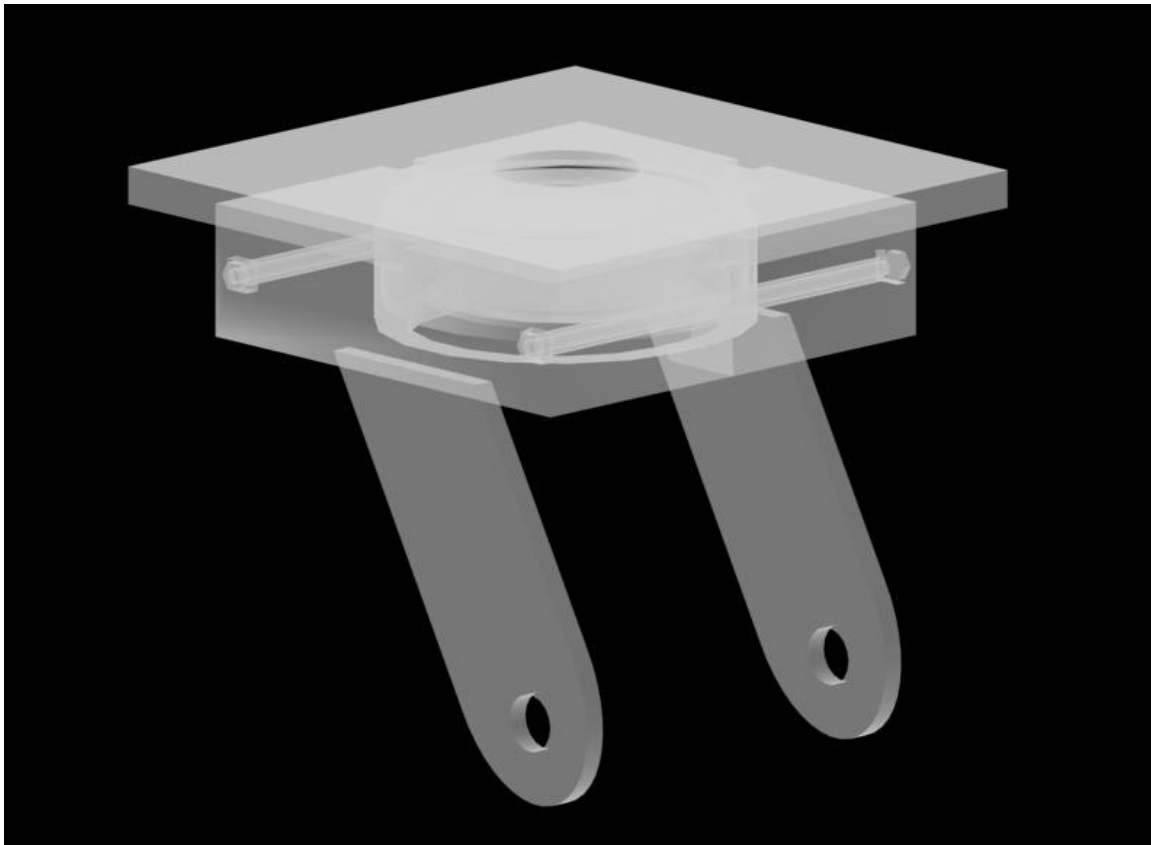

Brakes can be easily attached to the Bearing Housing by screwing.

Four slots are made on top of each side for the locking system.

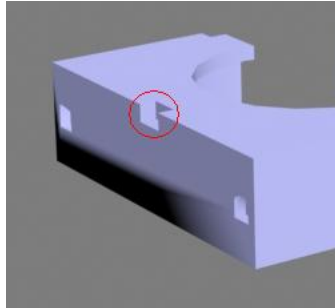

Advantages:

- Heat Treatment is not required.
- All components can be made by simple turning and water jet or laser cutting, within hours.
- No special tooling required for different products.
- Customized items can be made faster by simply modifying computer programs.
- Ideal for small batch sizes of 500 to several thousand pieces.
- Low inventory.

III. Concept 3

i. Concept 3.1

This design was approached from the ground up. The idea came about by thinking of the purpose of a caster and designing a simple mechanism to achieve the same task a current caster fills today. The design makes the assumption that a tube full of balls of smaller size and clamped between a steel plate and a large sphere with a diameter very close to the size of the tube diameter will act as a bearing. It assumes that the balls will allow the main sphere to roll in any direction and anytime without the need for a torque. This will theoretically make the movement of any load the caster is holding easier. It is also assumed the friction between the walls of the tube, the top plate, and the roller balls is small enough to allow free rolling between the main sphere and the roller balls. Below is a picture of what the previously described design may look like.

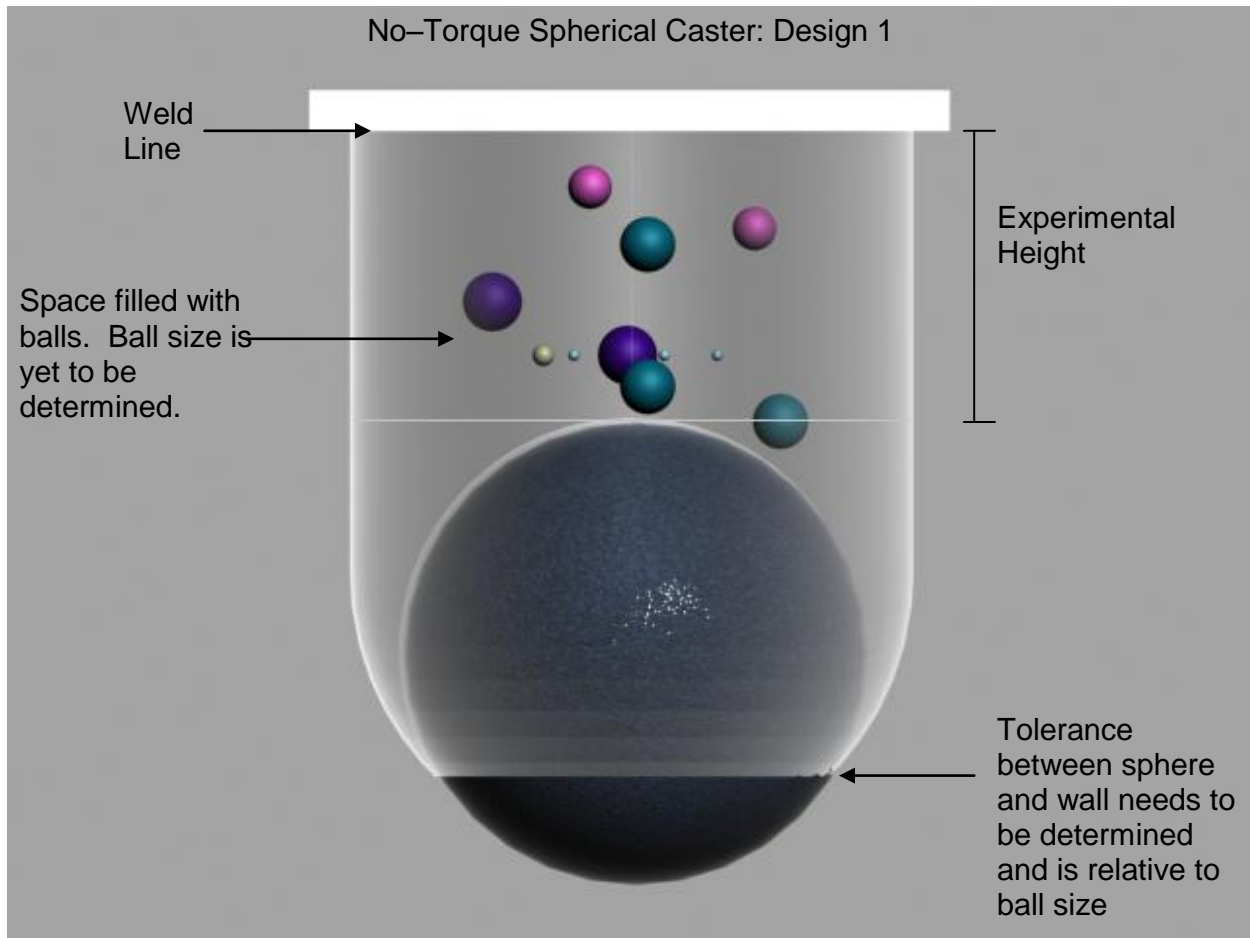

The space where the multi colored balls are would be completely filled with a experimentally determined size of ball. This idea is based on the same idea that if the balls in the empty space were made infinitely small they would be a liquid and it is known if the balls could somehow be a liquid without leaking out then this design would surely work. However, since the design group was unable to determine a way for a liquid to be in the space between the main black sphere and the top plate it was decided to use the next best thing hence the idea of many small balls to fill the space. The space between the main sphere and the outer tube would need to be kept smaller than the diameter of the roller balls lest the roller balls would leak out just like a liquid.

The assembly of the part would be very simple. First the materials needed would only be thick wall tubing, standard steel balls, the main sphere and steel plate. The top plate would need to be cut from the steel plate and have the bolt hole punched/cut and tapped. The thick wall tube would need to be cut to the proper height and turned in order to obtain the "crimped" end. Then the main sphere would be loaded in and the top plate welded on. The roller balls would be fed into the empty space through an extra hole in the top plate and a plug could then be inserted.

The advantages of this design would be that there is no torque required on the wheels in order for the carried-load to be turned. The "caster" would sit directly beneath whatever it was supporting and therefore there would be no wheels to stick out and trip people or snag other items. The assembly is very simple and would be very quick. This is very important because the main goal of the project is to be able to ship a caster out very quickly. All of the need materials could be ordered standard from the market except possibly the main sphere, but that will need to be determined experimentally. Also, only three machines would be required in order to assemble the part: a turning machine to obtain the crimp at the end of the tube, a cutting machine for the tube and the top plate, and a welding machine to attach the top plate to the tube. The cutting would be automated and the only skilled worker that would be needed is a welder but that could possibly be automated as well. A worker would only need to move the part from one machine to another and load in the roller balls once the part had been welded.

ii. Concept 3.2

This concept was arrived at by first looking at the previous concept and trying to improve on it, however both concepts are equally plausible and therefore both are being presented. The main difference from the previous concept is that instead of a space filled with balls there is now a ring of balls that will act as a bearing. The design of this new bearing should allow the main sphere to roll in any direction at anytime and allow turning without the need for torque on the "caster" (it sits directly beneath the load). The ring of balls will also support the vertical load.

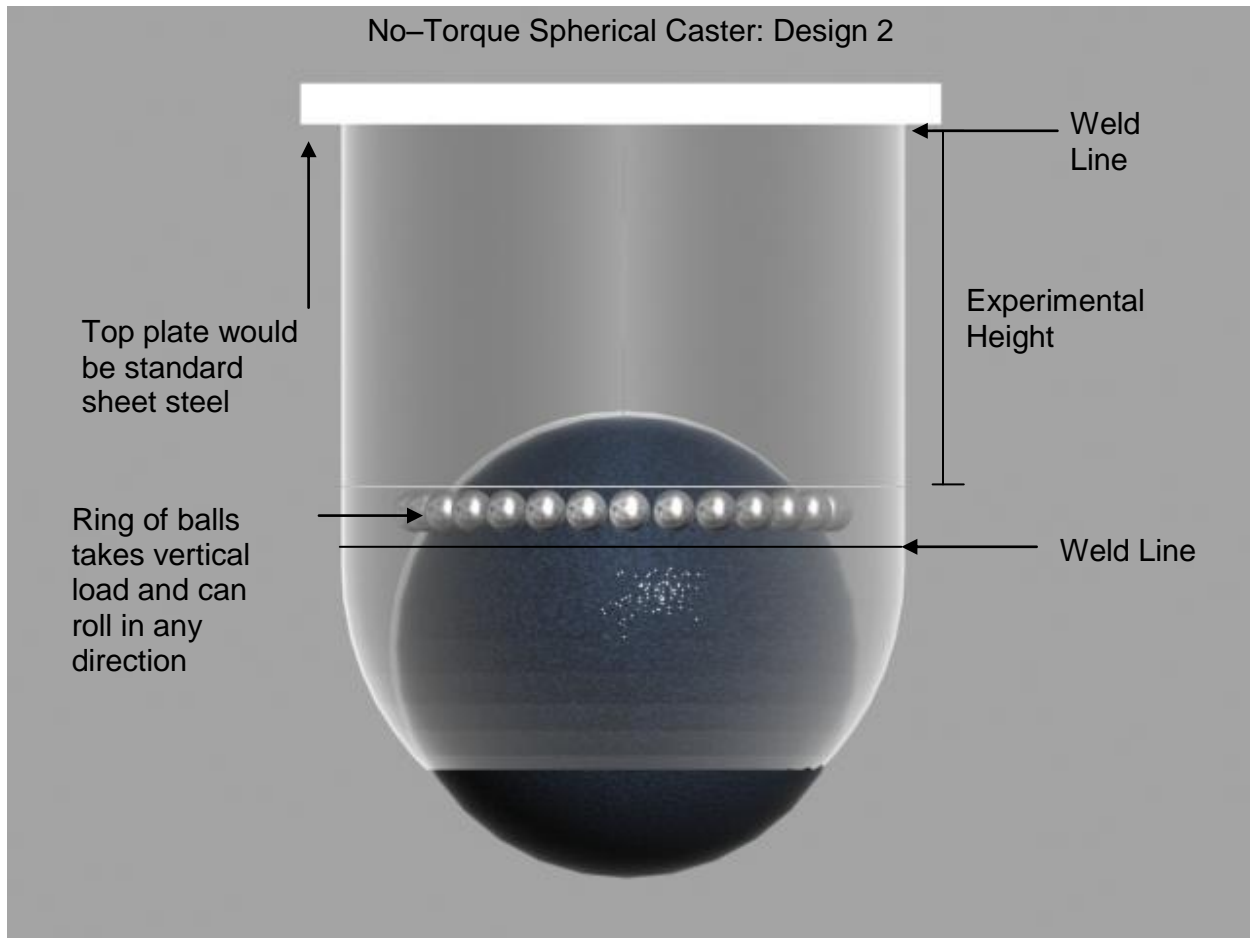

The materials for this concept are the same as the previous concept: thick wall tubing, steel plate, steel balls, and the main sphere. Once again, the material for the main sphere would have to be determined experimentally. Another difference in this design is that a raceway will have to be machined into the thick wall tubing and then heat treated. The heat treatment process used could be the same as in Concept I (laser heat treating).

The assembly of this design would be relatively simple. The thick wall tube would need to be cut into two separate pieces. One piece would be turned to achieve the "crimping effect." The other end would have the top plate welded to it. The top plate needs to be cut from sheet steel using prior mentioned methods i.e. water jet or laser cutting. Then the holes would need to be cut and tapped. The reason the thick wall tube is cut into two pieces is to allow the main sphere to be loaded in. The crimped end is smaller than the main sphere and the raceway is smaller as well and hence the main sphere needs to be loaded between the two halves and then welded inside. A hole will be needed that connects the outer wall of the tube to the inner raceway. This way the steel balls can be loaded in after the weld and this will secure the main sphere in place. The whole could then be plugged. This would also allow for the roller balls to be further lubricated if need be

or completely replaced in the event of a failure of the material. It is also possible, although not shown, to bolt the top tube to the bottom tube via counter-sunk screws and tapped holes in the top half. This would allow for the main sphere to be replaced if needed. Two additional machines are required to make this design versus the previous spherical design: a turning machine to carve out the raceway and a heat treatment laser to harden the raceway. These two extra machines would not take up much space in the factory and would not and enough time to the manufacturing time to disallow the caster from being "in by morning and out by night"

5. Meeting with Mr. Pritzker

On April 25th, we presented the three concepts to Mr. Pritzker and Chuck Harris. Will Maurer began the meeting by explaining what the team did in the duration of this semester. He explained that we only looked at the metal parts of the caster and not the wheels or brakes. He also explained that we ultimately created concepts of casters that could be made in the morning and shipped in the afternoon.

The formal presentation began with Jim Sherrod explaining the targets, visions, and ideas of the group. He talked about how "value engineering" was important in each step of this project. Jim also discussed the trip to Albion and how it helped us progress with our research. From there, Jim began explaining how the first concept was designed and how it could be manufactured. After Jim finished his part of the presentation, Udit Dave presented the design and manufacturing process for concept 2 with Will Asherman presenting concept 3 after Udit.

Questions and Answers:

Q: Could a laser possibly cut metal as well as heat treat the raceway?

A: No one has really asked for the technology, but they have machines that are dual purpose, so it is doable.

Q: How many of these casters could be produced per day?

A: We did not have time this semester to make a prototype or test how fast it could be made.

Q: How is the Queen Pin assembled?

A: The Queen pin has two parts that are screwed together during production to hold the caster together.

Q: Have there been any tests for quality?

A: We have not had time to do any tests this semester.

Q: For the third design, were obstacles given thought in the design process?

A: They were not given much thought as of now.

Q: For the third design, how is the race way placed?

A: The bearing will sit in between the raceway and the main ball.

6. Future steps

At the end of the meeting with Mr. Pritzker and Chuck Harris, they gave suggestions on what the next IPRO should research. Following is a list of their suggestions:

- Cost Analysis
- Simulations
- Prototypes
- Testing (safety, durability, etc.)

Appendix

Appendix A – Trip to Albion

LOCATION

Albion Industries, INC.
800 N. Clark Street
Albion, MI 49224
www.albioninc.com
1-800-835-8911

PERSONNEL LIST

ALBION

Mr. Pritzker, President and CEO of Colson Associates (not present)
Mike Thorn, VP Sales and Marketing
Bill Winslow, Plant Manager
Steve Spriggs, Sales Engineer
Tom Kidder, Sales Engineer
Ken Otmanowski, Engineering Manager (not present)

IIT

Will Maurer, Instructor	Udit Dave
Abel B. Comeche	Choi (Mike) Seung II
Re'Lana Gomez	Mohit S. Bansal
Kue-Dong Park	Jim Sherrod

INITIAL MEETING

Steve Spriggs, upon directing our group to a meeting room, began the introductions with recognizing Tom Kidder, a former tool room supervisor and long-term employee who recently became a sales engineer. Steve then described himself, which includes a long tenured background of thirty-plus years. Mike Thorn and Bill Winslow were not initially available.

During Albion's introductions, Steve and Tom inquired about our reasons for visiting their facility and acknowledged they had a limited idea regarding our project's scope and objective's. This limited information was relayed to them via Ken Otmanowski and based upon Ken's visit at IIT on 1/31/06. Steve seemed concerned if he would be able to address our questions fully without knowing exactly what we would like to accomplish.

Will Maurer suggested the IIT visitors introduce themselves and then proceed with our scope and objectives. As the IIT students began introductions, Bill Winslow was able to join us. After student introductions, Will addressed Steve's concerns by updating Albion regarding our goals and objectives for the visit as outlined by Mr. Pritzker.

The overall project's objective is defined as, "Investigating means to rapidly manufacture casters within a 24 to 48 hour time frame." To accomplish this objective, our group needed to identify: What are the different types of casters produced today? What manufacturing techniques are required to produce those caster types? What alternative production methods to produce the casters may exist? Which steps are limiting the ability to expedite the production of casters? What do customers expect at the time of their purchase?

The goal of IIT's plant visit was to identify some answers to the preceding questions and not to discredit Albion's manufacturing ability or techniques, nor suggest different manufacturing improvements or production practice's at their facility. We broke into two groups; one led by Steve the other by Tom.

PLANT TOUR

Manufacturing Steps & Equipment:

- Punching: manually feed material strips into (2)70 ton presses
(1) 200 ton press, and (1) single hole piercing fabricator
- Shearing: (1) small fabricator, scissor like operation with fixtures
- Forming: Use of the punching presses again with interchangeable die sets
- Milling / Turning: NC machines. G-Code written by operators at machine
- Cutting: (1) manually operated pantograph type cutting torch. Part outline supplied as full-scale traceable drawing.
- Welding: Manual and Robotic stations, which generally require fixtures
- Grinding: To clean-up surfaces and edges
- Painting: Looked to be liquid enamel, small single color paint booth.

Materials:

Iron Castings, steel Forgings, taper and ball bearings, various hardware, and strip plate stock (generally ¼" thick, low carbon steel 1008 or 1010)

Inventory:

Large amounts of inventory housed in separate building with adjoining causeway. Consists of all types of unfinished upper/lower housings and different types of wheels

Ergonomics:

Moving large steel strips from floor level to punching level
Handling of impact gun at time of king-pin assembly operations
Bending and stacking of parts into bins located at floor height

Quality:

Directly asked question regarding quality department, was told one didn't exist at this location, however, the Georgia facility contained one if required.

Observations (no order of precedence):

We were surprised to see the use of castings, which requires outside vendors to supply first a pattern (made from aluminum) and then the actual part; additionally, the use of forgings, which requires tooling and outside vendors. This is generally done for large scale, repeatable items. Turning and milling operations are still required to obtain final shape. Use of castings/forgings is based on saving material vs. machining bar stock but limits manufacturing flexibility.

Heat-treating and plating operations for these components are both done by outside vendors.

This use of outside vendor/suppliers may in part explain the need for large inventory quantities in conjunction with the mass variety of wheels and assemblies. It would be interesting to see an inventory requirement comparison of material savings, floor space, and carrying cost of castings/forgings vs. raw material (NC metal removal processes).

The use of taper roller bearings vs. ball bearings is based upon the load rating of the caster. The larger the load, taper roller bearings are used. Taper roller bearings require a load; otherwise they seem difficult to operate. Ball bearings are used to maintain assembly of the upper and lower housings for the king-pin-less designs. The balls are inserted via access holes after assembly of the two housings. Ball bearing assemblies are used for lighter loads, smoother initial movement, and ergonomic compliance.

Robotic welding required three identical fixtures located at 0 degrees, 270 degrees, and 180 degrees. The operator would have to move ahead of the welder, removing completed items and pre-position new assemblies within the fixtures before the welder would reposition. Use of a rotary table at this station would have been nice.

We asked, "Are welding fixtures required to be established even for smaller custom jobs prior to shop assembling?" Steve replied, "Not always, however it will slow down the process by having to manually align and weld the assemblies, but can be done."

We did observe shearing operation of the legs required a separate fixture for each of the left and right sides. If a custom leg or other part was required on a small scale, an individual part would need to cut, one at a time using a

pantograph type cutting torch and a full scale print of the part. This operation could benefit from CNC application.

NC machine programming for forgings/castings was done by shop floor personnel.

The torching/cutting and machining operations could benefit from use of software generated G-Code. This would minimize set-time and maximize throughput.

Painting operations were very minimal. Most parts were clear-zinc plated by outside vendors.

CONCLUDING MEETING

Following the quick plant tour (due to time constraint), the group's re-convened back at the meeting room and was joined by Bill Winslow and Mike Thorn. At this time, the students asked various questions to clarify what was seen on the shop floor.

Bill Winslow pointed out that heat-treating was a major factor in considering time constraints for quick shipments. Turn around time required a minimum 72 hours. Bill was opposed to having an in-house heat-treating facility due to the requirement for having a metallurgist on staff and the consumables needed to operate an oven. This would add to overhead cost for the building.

Mike Thorn commented that the "special" order side of the business is approximately 6 to 8 million dollars and these orders are normally small batch sizes.

Steve pointed out that Albion is competing mostly on price. He noted that if competition has presented a lower price and can deliver in a comparable time frame, then customers would buy the competitor's products. Steve did not want to contradict the words of Mr. Pritzker; however, in his opinion price is a very important negotiation tool. Mike Thorn seemed to agree.

Steve did note that Albion was able to ship standard products in 24 hours, but the problem is the "specials" (product not in the catalogue).

We thanked our host's for their time and returned to Chicago.

Appendix B – References and Bibliography

Caster Companies

Faultless Caster, <http://www.conveyercaster.com/manufacturers/faultless-casters.htm>

ALBION, <http://www.conveyercaster.com/manufacturers/albion-casters.htm>

Shepherd Caster Corporation,
<http://www.conveyercaster.com/manufacturers/shepherd-casters.htm>

Darnell-Rose, <http://www.conveyercaster.com/manufacturers/darnell-rose-casters.htm>

Hamilton Caster, <http://www.conveyercaster.com/manufacturers/hamilton-casters.htm>

RWM Casters, <http://www.conveyercaster.com/manufacturers/rwm-casters.htm>

Darcor , <http://www.conveyercaster.com/manufacturers/darcor-casters.htm>

Caster Concepts, <http://www.conveyercaster.com/manufacturers/caster-concepts.htm>

Kingpinless™ Information,
<http://www.conveyercaster.com/casters/kingpinless-casters.asp>

MISC.

(ICWM) Institute of Caster and Wheel Manufacturers is part of the Material Handling Institute http://www.mhia.org/psc/PSC_Products_casters.cfm

ANSI ICWM – 2004 The North American Performance standard for casters and wheels. <http://www.mhiastore.org/category.cfm?Category=43>

Materials Moving; casters link on left side of page.
<http://www.materialsmoving.com/index.htm>

Albion Caster's
800 N. Clark Street, Albion, MI 49224
<http://www.albioninc.com/>

MUVTONS caster's
<http://www.muvtons.com/about-us.html>

Caster Info

<http://www.industrial-casters.net/info/industrial-casters/associations.htm>

Selecting the Right Caster; MHEDA Journal Online

http://www.datakey.org/mhedajournal/4q99/otmansowski_a.php3

Time Compression Technologies

<http://www.time-compression.com/x/default.html>

Advanced Technology Programs / NIST (National Institute of Standards and Technology)

<http://www.atp.nist.gov/atp/brochures/manufacturing.pdf>

RP House – Moeller Design & Development

<http://moellerdesign.com/about.htm>

SME. Org [http://www.sme.org/cgi-](http://www.sme.org/cgi-bin/communities.pl?/communities/rpa/rpahome.htm&&&SME&)

[bin/communities.pl?/communities/rpa/rpahome.htm&&&SME&](http://www.sme.org/cgi-bin/communities.pl?/communities/rpa/rpahome.htm&&&SME&)

Article: Machine Design

<http://www.machinedesign.com/ASP/viewSelectedArticle.asp?strArticleId=56284&strSite=MDSite&Screen=ARCHIVE>

Article: Desktop Engineering [http://www.deskeng.com/Articles/Resource-](http://www.deskeng.com/Articles/Resource-Guide/Direct-Metal-Comes-on-Strong-20050831591.html)

[Guide/Direct-Metal-Comes-on-Strong-20050831591.html](http://www.deskeng.com/Articles/Resource-Guide/Direct-Metal-Comes-on-Strong-20050831591.html)

Colson - Series 4 casters

<http://www.colsoncaster.com/4series-800-casters.html>

Colson Plastics

<http://www.colsonplastics.com/monette.html>

The Marmon Group

<http://marmon.com/>

Trade Show

<http://www.sme.org/cgi-bin/get-evdoc.pl?&&001612&000007&019920&&SME&>

Rapid Prototyping Systems

3DSystems

<http://www.3dsystems.com/company/index.asp>

Stratasys

http://www.stratasys.com/sys_fdm.html

RP House – Moeller Design & Development <http://moellerdesign.com/about.htm>

Dimension 3D printers <http://www.dimensionprinting.com/3Dprinting.html>

Zcorp 3D printers <http://www.zcorp.com/>

DSM Somos : Material researcher

http://www.dsm.com/en_US/html/dsms/home_dsmsomos.htm

BENDING / FORMING

EUROMAC, 16-72 TON HYDRAULIC BENDING MACHINE

an Italian company with global presence,
established in 1986, designs, develops, produces
and sells traditional and CNC fabricating machine tools.
CNC Punching, Notching, and Bending

<http://www.euromac.it/php/index.php?lingua=eng>

BENTEC, 11-15 TON HYDRAULIC BENDING MACHINE

a division of KIFFER INDUSTRIES INC.
a U.S. company located in Cleveland, OH

<http://www.kiffer.com/>

<http://www.bentecbenders.com/main.html>

BENDHOR, 33-55 TON HYDRAULIC RAM BENDER

Only found distributor, OCEAN MACHINERY INC.
based in south Florida.

<http://www.steelfabricatingmachinery.com/>

<http://www.oceanmachinery.com/bendhor-machinery-bendhor-products-bendhor-machines.htm>

Carell, 22-100 TON HORIZONTAL PRESS

Located in Stapleton, AL

<http://www.carellcorp.com/>

IPS, 22-100 TON HORIZONTAL PRESS BREAK

INTER PLANT SALES, Hopkins, MN

<http://www.interplantsales.com/>

SIMASV, 22-100 TON HORIZONTAL PRESS BREAK

an Italian company, Vicenza, Italy

Claims to be the first to market

horz. press break in 1957

<http://www.simasv.it/>
<http://www.simasv.it/eng/azienda.htm>

CUTTING

HAAS, CNC TURNING CENTER with SL-20APL Automatic Parts Loaded
http://www.haascnc.com/LATHE_Main_default.asp#CNCLatheTree

Heat Treating

Laser Heat Treating
<http://www.uslasercorp.com/envoy/heattreating.html>

COATINGS

Article

<http://www.pfonline.com/articles/1205qf2.html>
Is In-house E-Coating Right for your Company?

<http://www.pfonline.com/articles/030604.html>
Building an E-Coat Line from the Ground Up.

http://www.btr-plating.com/e_coat_page.htm
BTR Plating Resources

Electrocoating offers several advantages in the finishing of metal products. The uniform coating resists corrosion and is superior to other coating applications. The applied coating contains very little water, thereby eliminating runs or sags and allowing the parts to be handled almost immediately. Electrocoating waste is minimal, drastically reducing material costs. Low solvents and water-based formulations make electrocoating the perfect finish for an environment-friendly future

<http://www.birchwoodcasey.com/trutemp/examples.html>
<http://www.birchwoodcasey.com/trutemp/trutemp-areas.html#02>
True Temp coating